



aerospace
climate control
electromechanical
filtration
fluid & gas handling
hydraulics
pneumatics
process control
sealing & shielding



Control Devices

Catalogue PDE2614TCUK-ca. July 2010



ENGINEERING YOUR SUCCESS.

Table of Contents

A	ISO Valves	7 - 55
B	ISYS	23 - 49
C	Isysnet	56 - 78
D	Isys Micro Valves	79 - 110
E	ISO Valves for the Rail Industry	111 - 128
F	Moduflex Valve System	129 - 174
G	Valvetronic Valves	175 - 206
H	PS1 Modular Interface Valves	207 - 212
I	PVL-B / PVL-C Inline Valves	213 - 234
J	Viking Xtreme Valves	235 - 274
K	B Series Valves	275 - 302
L	Midget & Intermediate Manual & Mechanical Valves	303 - 320
M	Directional Control Valves	321 - 336
N	Heavy Duty Poppet Valves	337 - 346
O	Limit Switches, Bleed Sensors	347 - 360
P	Logic Processing	361 - 388
Q	Man / Machine Dialogue	389 - 400
R	Vacuum Products	401 - 406
S	Adex Valves	407 - 429

 **WARNING**

FAILURE OR IMPROPER SELECTION OR IMPROPER USE OF THE PRODUCTS AND/OR SYSTEMS DESCRIBED HEREIN OR RELATED ITEMS CAN CAUSE DEATH, PERSONAL INJURY AND PROPERTY DAMAGE.

This document and other information from Parker Hannifin Corporation, its subsidiaries and authorized distributors provide product and/or system options for further investigation by users having technical expertise. It is important that you analyze all aspects of your application and review the information concerning the product or system in the current product catalog. Due to the variety of operating conditions and applications for these products or systems, the user, through its own analysis and testing, is solely responsible for making the final selection of the products and systems and assuring that all performance, safety and warning requirements of the application are met. The products described herein, including without limitation, product features, specifications, designs, availability and pricing, are subject to change by Parker Hannifin Corporation and its subsidiaries at any time without notice.

SALE CONDITIONS

The items described in this document are available for sale by Parker Hannifin Corporation, its subsidiaries or its authorized distributors. Any sale contract entered into by Parker will be governed by the provisions stated in Parker's standard terms and conditions of sale (copy available upon request).

Parker Hannifin

Parker Hannifin is one of the world's leading suppliers of products and solutions in Motion and Control. Using innovative product development and an acquisition strategy to increase our range of pneumatic products and solutions, we now have one of the broadest product offerings available in the market.

Our range now extends from the compressor to the point at which the air is used. This could be supplying power

take off on a vehicle, moving a cylinder or gripper to milking cows. The design and manufacture of bespoke integrated solutions for air, gas and fluid control is one of our core specialisation.

The Parker network of distributors is the most comprehensive in the world, which means our products are available from specialist pneumatic distributors wherever you are located.

In the following pages are listed the core first choice products from across Parker which are aimed at the pneumatic market. From valves, actuators and air preparation to push in fittings quick connectors and tubing to customized systems. In this catalogue you will find products from Pneumatic Division Europe, Legris, Rectus Tema, Fluidconnectors, KV and Fluid Controls, presenting an unrivalled choice of products and solutions to suit virtually any application.



DX ISO Valves



p7

- ISO sizes 02, 01, 1, 2 & 3 sub base & manifold mounted valves
- ISO 5599-1 & ISO 15470-1
- Excellent reliability, in excess of 100 million cycles
- High flow performance & quick response times
- Ceramic slide technology operates on Lubricated or non-lube air

Isys Valves



p23

- ISO sizes 02, 01, 1, 2 & 3 sub base mounted valves
- ISO 5599-1, ISO 5599-2, ISO 15470-1 & ISO15470-2
- Stable long lasting performance
- Heavy duty metal bodies
- Wear compensating seal technology

Isys Net

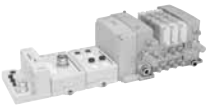

p56

- A complete field bus communication offering for valve islands
- Extremely fast I/O back plane uses change of state connections to maximise performance
- UL, C-UL and CE certifications
- Accepts signals from sensors, photo eyes, limit switches and other field input devices
- Communication module supports up to a maximum of 63 I/O and up to 264 inputs/outputs

Isys Micro Valves

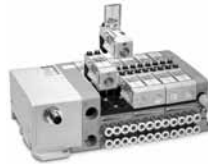

p79

- Up to 8 pneumatic functions on a 42mm width metal sub base
- 4 valve modules back to back for compact dimensions
- High performance
- Optimized flow for 6mm tubes
- Side of bottom mounted manifolds available.

Iso Valves for the Rail Industry



p111

- Door control systems
- Coupling systems
- Sanding control systems
- Pantograph systems
- Parking brake
- Trip cock reset valve
- Internal and external door actuation and control

Moduflex Valves - P2M



p129

- High flow, compact size.
- Mixable valve sizes.
- Stand alone valves, modular islands with individual, multi connector or bus connections.
- Integrated selectable internal or external pilot supply and exhaust.

Valvetronic Valves



p175

- 3/2 or 4/2 configurations
- Push-in connections Ø4mm and Ø6mm
- High performance 15mm solenoids
- Electrical connection: Cable gland, Sub D25 or Industrial connector
- Bus protocols: Interbus S, Profibus DP, Devicenet ASI

PS1 Interface



- High speed poppet valve
- Push-in connection
- Built-in terminal block
- Pneumatic output indicator
- DIN rail mounting

p207

PVL-B / PVL-C Inline Valves



- Compact lightweight
- 2 x 3/2, 5/2 or 5/3 configuration
- Push-in Ø8mm or G1/4 threaded connections
- High performance 15mm solenoids
- Stacking type modules with DIN rail mounting

p213

Metal Spool Valves - Viking Xtreme



- 4 sizes: G1/8, G1/4, G3/8 and G1/2.
- Compact design with good corrosion resistance.
- Wide range of 5/2 and 5/3 versions.
- High and low temperature versions available for transport applications.

p235

B Series Valves



- 2 sizes 1/8" and 1/4"
- Compact size
- Inlet-exhaust mounting facility
- Fast response, high flow
- Integrated mounting holes
- Wear compensating seal system

p275

Midget & Intermediate Valves



- G1/8 or G1/4 body ported
- Rugged die-cast body
- 3/2, 5/2 & 5/3 configurations
- Stainless steel spool
- Viton body seals as standard
- Integral mounting holes
- Manual, mechanical and automatic actuators

p303

Directional Control Valves - VA



- Rugged valves for heavy duty applications
- Large and robust actuators for easy operation
- Excellent corrosion resistance
- Integral mounting holes
- Panel mounting versions

p321

Heavy Duty Poppet Valves



- G3/8 & G1/2 body ported
- 2/2 & 3/2 NC spring return as standard
- High flow poppet design
- Manual and mechanical and solenoid actuators
- Light actuation forces
- Integral mounting holes

p337

Limit Switches, Bleed Sensors



- High durability
- Very good repeat accuracy
- Design for process duty cycle
- Push-in or threaded connection
- Versatile and easily maintained
- Wide range of body size and actuator style

p347

Logic Processing



- Complete range of logic processing modules
- Stand alone or stackable and combined units
- Ultra fast response times
- Visual indication
- DIN rail mounting

p361

Man / Machine Dialogue



- Push button valves Ø22mm
- Visual indicators Ø22mm and Ø30mm
- Two-hand control units

p389

Vacuum Products



- Flat & Bellows pads
- Male & female connections
- Different materials
- Range of diameters
- Basic ejectors
- Basic ejector with electro-mechanical switch
- Inline ejectors

p401

Adex Valves



- 2 sizes M5 and 1/8"
- Compact body with large flow
- Quick response time, faster than 10ms
- Expected life time more than 50,000,000 cycles
- Low power consumption only 0.6W

p407

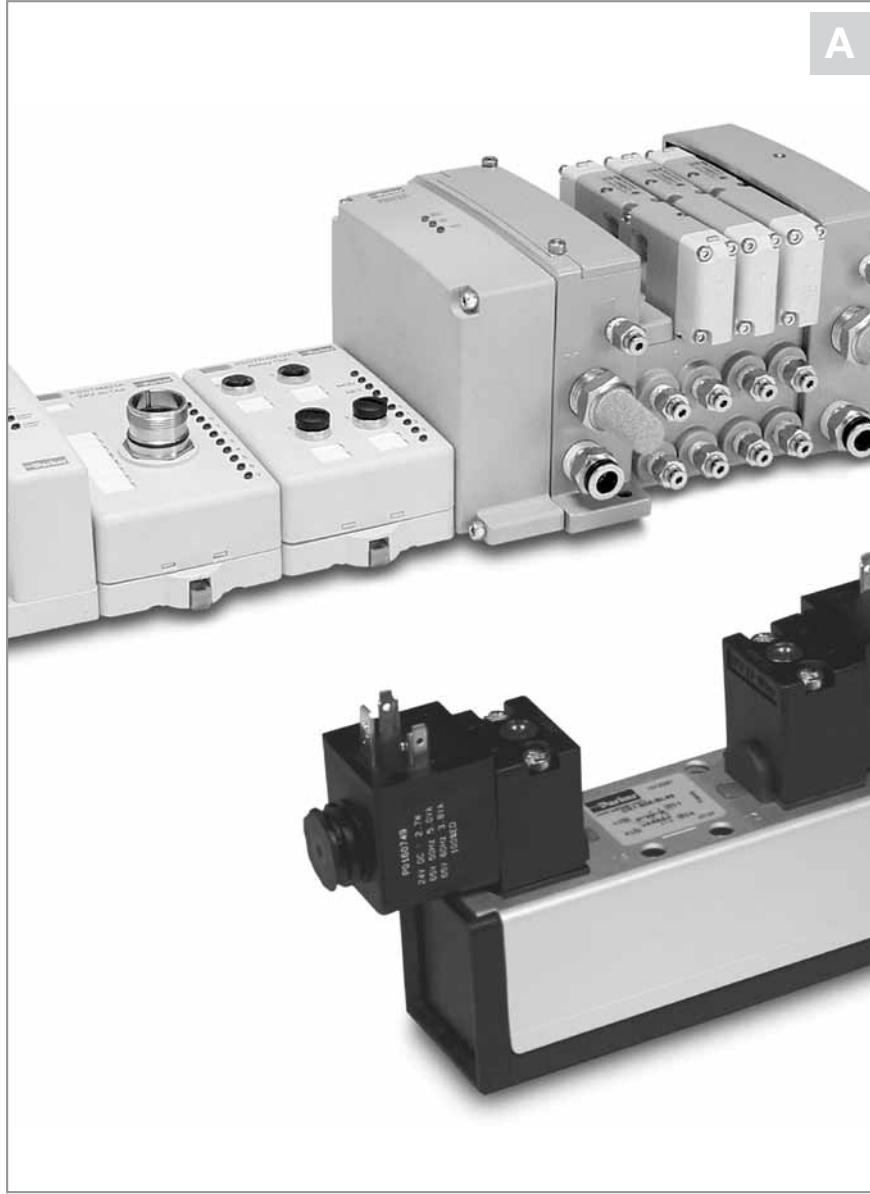

ISO Valves

A complete range of pneumatic ISO valves
ISYS and **ISOMAX**

ISO Specifications

A



5599-1



External electrical connection subbase valves

The ISO Standard 5599-1 specifies an interface pattern for a common subbase valve consisting of pressure passages 1, 3, 5, 2 & 4 and pilot passages 12 & 14. The width of the pattern and location of the 4 bolt holes are also specified. There are no specifications for the type of external electrical connection used to control the valve.

Size : 1 2 3



5599-2



Body-to-base plug-in subbase valves

Same as 5599-1 for pneumatic pressure passages, 5599-2 standard also specifies a plug-in electrical connection.

Sizes : 1 2 3

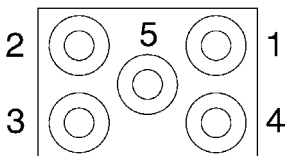

- 1 = 12 solenoid
- 2 = 14 solenoid
- 3 = 12 solenoid
- 4 = 14 solenoid
- 5 = Ground

ISO Specifications

A



15407-1

(VDMA 24563)



ISO 15407-1

External electrical connection subbase valves

The ISO Standard 15407-1 specifies an interface pattern for a common subbase valve consisting of pressure passages 1, 3, 5, 2 & 4 and pilot passages 12 & 14. The width of the pattern and location of the 4 bolt holes are also specified. There are no specifications for the type of external electrical connection used to control the valve.

Size : 02 01



15407-2



ISO 15407-2

Body-to-base plug-in subbase valves

Same as 15407-1 for pneumatic pressure passages, 15407-2 standard also specifies a plug-in electrical connection.

Size : 01 02

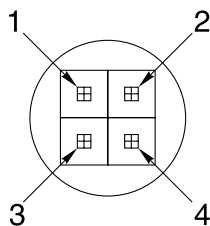

Pin 1 = 14 solenoid

Pin 2 = 12 solenoid

Pin 3 = Ground +







Pin 4 = Common -



ISO 15407

Size 02 / 01

Cylinders from Ø 10 to 100

A

ISO 15407-1 Individual Connection	DIN C	Isomax 	
	M12	ISYS ISO 	
	Remote pilot	Isomax 	ISYS ISO 
	Subbase, Manifolds		
	Flow Control, Regulator		









ISO 15407-2 Plug-in	Plug-in	ISYS ISO 	
	Subbase, Manifolds		
	Flow Control, Regulator		



ISO 5599

Cylinders from Ø 63 to 200

Size 1 / 2 / 3

A

ISO 5599-1	Individual Connection	DIN A, Industrial	Isomax 	ISYS ISO 
		M12, M23	Isomax 	ISYS ISO 
		Remote pilot	Isomax 	ISYS ISO 
		Subbase, Manifolds		
		Flow Control, Regulator		

ISO 5599-2	Plug-in	Plug-in	ISYS ISO 	
		Subbase, Manifolds		
		Flow Control, Regulator		

A

Isomax - General Applications

Market Application

- Automotive Handling
- Packaging
- Manufacturing
- General application

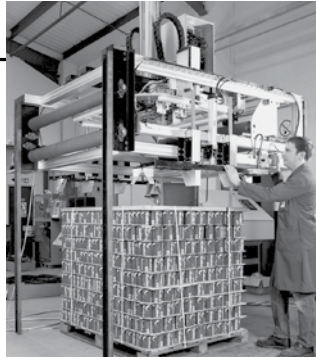

Ceramic technology

All ISOMAX products use high-tech ceramic switching technology :

• Excellent reliability :

Long life in excess of 100 million operations*.
Operates with lubricated or non lubricated air.
Low sensitivity to air quality changes ;
switching without seal.
Stiction free.

• Size 02 & Size 01

Solenoid exhaust pilot

• High performances :

Slide valve concept allows high flow / size ratio and short response time due to short slide stroke and low friction.

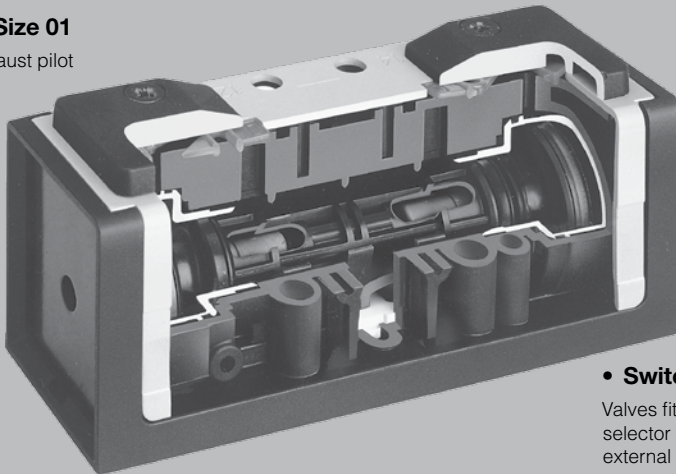

• Switchable selector

Valves fitted with switchable selector to give internal or external pilot supply

• Stable long lasting performances

Low friction switching : minimum wear of the valve member/seal assembly.

Ceramic plate

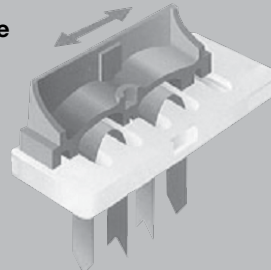

Rust and corrosion resistant body

With the valve body in polyamide reinforced fiberglass and the casting in anodised aluminium, the Isomax range presents a comprehensive modern design to suit most industrial environments.

Central M12 connection or M12 coil

All sizes of ISO 5599-1 are supplied with central M12 integrated connector, a M12 bridge cable or with a 30 x 30mm coil having M12 interface.

External supply selection

In order to use actuator with low pressure, it is possible to connect an external pressure on port 14 to supply both solenoids. Selection is easily made by reversing the gasket under the operator.

High reliability



Valves easily comply with the requirements for the component reliability in accordance with EU Machinery Directive standards EN292-2 and EN983.

Maintenance

Spares are not required for the main valve or spool but solenoid operators can be replaced if required.

Manual Override

Solenoids are available with locking or non-locking manual overrides so that valves can be operated when the electrical supply is turned off.

Solenoid valves, CNOMO interface, 15mm solenoid



The standard valve is fitted with a 30mm solenoid having DIN 43650 Industrial form A connector for sizes 1, 2 and 3 15mm solenoid for sizes 01 and 02.

Low noise level

Size 01 and 02 valves fitted with the 15mm solenoid option use captured pilot exhaust which is channelled through the valve body and exhausts to atmosphere through channel 12

High electrical encapsulation class

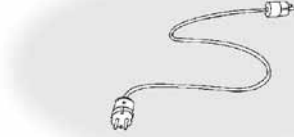

The solenoid valves are protected to IP65 with the standard cable plug. Available with DIN A or M12 connection.

Wide choice of solenoid connectors/cable plugs

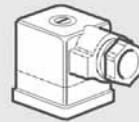

Solenoid connectors are available with or without LED and rectifier and may be selected fitted pre-wired with flying leads.

Valves having ATEX approval

ATEX approved options are available for use in explosive atmospheres. Consult our Technical Sales Department for further information.

Bottom or side ported manifold

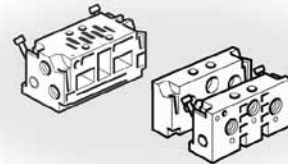

Manifolds with common ducts for ports 1,3 and 5, outlet port 2 and 4, and supply port for 12 and 14 are available side or bottom ported. Those manifolds are common for Isomax and Isys Iso.

Subbase installation VDMA

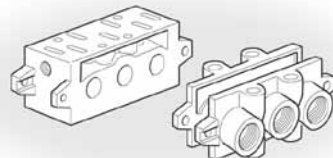

A large range of subbase, VDMA or not VDMA, bottom or side ported.

Isomax Flow Characteristics

Flow capacities in accordance with ISO6358, for 5/2 function. 5/3 function are around 10 to 20% less.

A

Technical Data Isomax Size 02

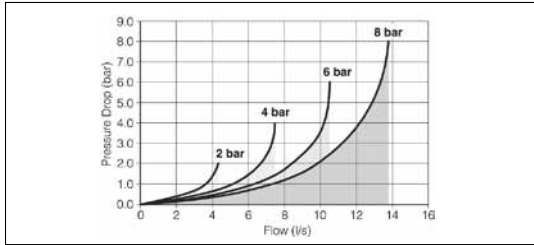

Operating pressure.
 5/2 Spring return 3,0 - 10 bar
 5/2 Differential 2,0 - 10 bar
 5/2 Double solenoid 1,5 - 10 bar
 5/3 Double solenoid 3,5 - 10 bar
 Working temperature. -10°C to + 60°C
 Flow (acc. to ISO 6358)
 $c = 1,5 \text{ NI/s} \times \text{bar}$
 $b = 0,25$
 $Q_n = 6,3 \text{ l/s}$
 $Q_{max} = 10,6 \text{ l/s}$

Technical Data Isomax Size 01

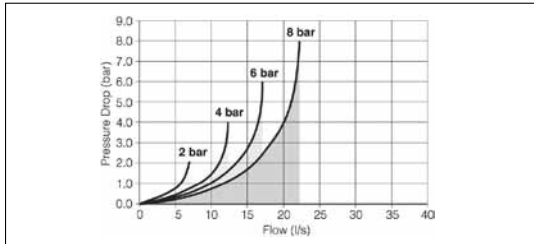

Operating pressure.
 5/2 Spring return 3,0 - 10 bar
 5/2 Differential 2,0 - 10 bar
 5/2 Double solenoid 1,5 - 10 bar
 5/3 Double solenoid 3,5 - 10 bar
 Working temperature. -10°C to + 60°C
 Flow (acc. to ISO 6358)
 $c = 2,5 \text{ NI/s} \times \text{bar}$
 $b = 0,25$
 $Q_n = 9,8 \text{ l/s}$
 $Q_{max} = 17,1 \text{ l/s}$

Technical Data Isomax Size 1

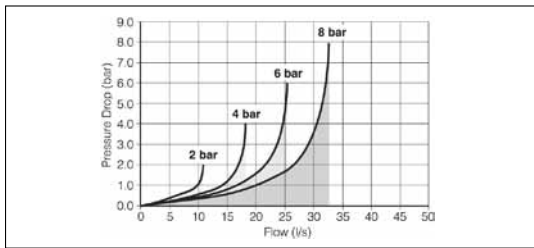

Operating pressure.
 5/2 Spring return 3,0 - 10 bar
 5/2 Differential 2,0 - 10 bar
 5/2 Double solenoid 1,0 - 10 bar
 5/3 Double solenoid 3,5 - 10 bar
 Pneumatic version 12 bar
 Working temperature. -10°C to + 60°C
 Flow (acc. to ISO 6358)
 $c = 3,8 \text{ NI/s} \times \text{bar}$
 $b = 0,35$
 $Q_n = 17,2 \text{ l/s}$
 $Q_{max} = 25,5 \text{ l/s}$

Technical Data Isomax Size 2

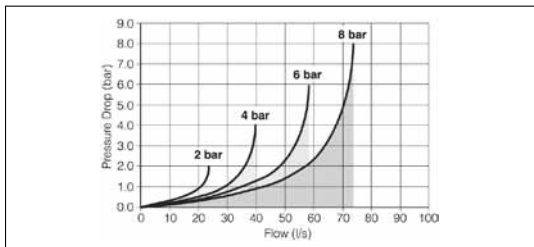

Operating pressure.
 5/2 Spring return 2,5 - 10 bar
 5/2 Differential 2,0 - 10 bar
 5/2 Double solenoid 1,0 - 10 bar
 5/3 Double solenoid 3,0 - 10 bar
 Pneumatic version 12 bar
 Working temperature. -10°C to + 60°C
 Flow (acc. to ISO 6358)
 $c = 8,2 \text{ NI/s} \times \text{bar}$
 $b = 0,35$
 $Q_n = 38,3 \text{ l/s}$
 $Q_{max} = 58,7 \text{ l/s}$

Technical Data Isomax Size 3

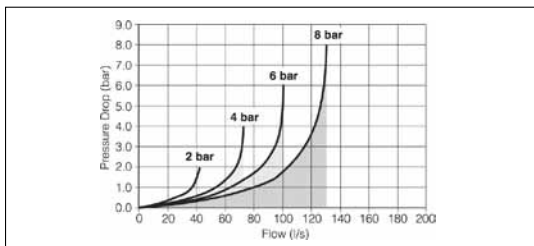

Operating pressure.
 5/2 Spring return 2,5 - 10 bar
 5/2 Differential 2,0 - 10 bar
 5/2 Double solenoid 1,0 - 10 bar
 5/3 Double solenoid 3,0 - 10 bar
 Pneumatic version 12 bar
 Working temperature. -10°C to + 60°C
 Flow (acc. to ISO 6358)
 $c = 14,5 \text{ NI/s} \times \text{bar}$
 $b = 0,35$
 $Q_n = 64,0 \text{ l/s}$
 $Q_{max} = 101,0 \text{ l/s}$

Isomax Material Specification and Characteristics

15407

Valve member - seat :	Self lubricating acetal - ceramic
Body :	Polyamide reinforced fibreglass
Casing - End plates :	Anodised aluminium - Painted zinc plated steel
Valve plate :	Zamak
Seals :	Nitrile
Springs :	Stainless steel
Screws :	Zinc plated steel
Function selector :	
Top cover - Seal :	Polyamide reinforced fiberglass - Polyester

5599

Valve member - seat :	Self lubricating acetal - ceramic
Body :	Polyamide reinforced fibreglass
Casing - End plates :	Anodised aluminium - Painted zinc plated steel
Valve plate :	Zamak
Seals :	Nitrile
Springs :	Stainless steel
Screws :	Zinc plated steel
Function selector :	
Top cover - Seal :	Polyamide reinforced fiberglass - Polyester

Characteristics

Fluid:	Air or inert gas filtered 40u class 5 according to ISO 8573-1 dry class 4 according to ISO 8573-1 non-lubricated, or lubricated
Storage temperature	-20° to + 70°
Vibration	according to IEC 68-2-6 2G 2 to 150Hz
Shock	according to IEC 68-2-7 15G 11ms
Manual override	Non-locking, other type on request

Characteristics

Fluid:	Air or inert gas filtered 40u class 5 according to ISO 8573-1 dry class 4 according to ISO 8573-1 non-lubricated, or lubricated
Storage temperature	-20° to + 70°
Vibration	according to IEC 68-2-6 2G 2 to 150Hz
Shock	according to IEC 68-2-7 15G 11ms
Manual override	Non-locking, other type on request

Certification

EMC / CE mark.	According to EN 61 000-6-2
Dust & water protection	IP65 according to EN 60529

Certification

EMC / CE mark.	According to EN 61 000-6-2
Dust & water protection	IP65 according to EN 60529

Isomax - ISO 15407 - 15mm Solenoid

Order chart

DX **01 - 6** **21 - 95** **1** **M** **S**

Size	
02	18 mm (ISO 15407)
01	26 mm (ISO 15407)

Pilot	
4	Pneumatic
6	Electro-Pneumatic

Voltage	
B	12 VAC
C	24 VAC
D	48 VAC
J	110 VAC
A	230 VAC
L	12 VDC
M	24 VDC
N	48 VDC

Shaded voltage part numbers are available from stock.
 Unshaded part numbers are available on request but will be subject to minimum order quantities.
 Otherwise order coil/solenoid and valve separately.

Valve type function	
Internal pilot supply / Capture exhaust 12	
06	5/2 double solenoid
56	5/2 double solenoid, 14 prioritised
21	5/2 single solenoid, spring return
51	5/2 single solenoid, differential return
11	5/3 double solenoid vented centre
16	5/3 double solenoid closed centre

Manual override	
0	Without any
1	Flush non locking
3	Flush locking
2	Flush non locking (extended 15 mm)
5	Flush locking (extended 15 mm)

External pilot 14 supply / Capture exhaust 12	
05	5/2 double solenoid
59	5/2 double solenoid, 14 prioritised
23	5/2 single solenoid, spring return
54	5/2 single solenoid, differential return
09	5/3 double solenoid vented centre
19	5/3 double solenoid closed centre

Electrical operator	
60	Without any *
95	15 mm solenoid 1,2 W DIN 43650 form C †

* Standard for Pneumatic version
 † Standard for electro-pneumatic version

Connector	
	Without any
C	Standard connector
S	Connector with LED and protection
S3	Connector with LED and protection - 3 m cable
S5	Connector with LED and protection - 5 m cable

Shaded part numbers are standard



A

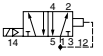
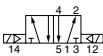
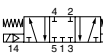
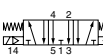

Solenoid operated ISO valve fitted with 15 mm solenoid 24 VDC

Solenoid plug/connector to be ordered separately.

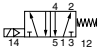
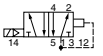
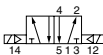
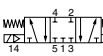

Symbol	Size	Actuation	Return	Changeover time (ms) at 6 bar actua./return	Weight kg	Order code
5/2 Valves						
	02 - 18 mm	Electrical signal	Spring	15/25	0.13	DX02-621-951M DX01-621-951M
	01 - 26 mm	Electrical signal	Spring	25/35	0.17	
	02 - 18 mm	Electrical signal	Differential	15/30	0.13	DX02-651-951M DX01-651-951M
	01 - 26 mm	Electrical signal	Differential	20/40	0.17	
	02 - 18 mm	Electrical signal	Electrical signal	12/12	0.17	DX02-606-951M DX01-606-951M
	01 - 26 mm	Electrical signal	Electrical signal	15/15	0.21	
5/3 Valves						
	02 - 18 mm	Electrical signal	Electrical signal	20/60	0.17	DX02-616-951M DX01-616-951M
	01 - 26 mm	Closed center	Self centering	20/60	0.21	
	02 - 18 mm	Electrical signal	Electrical signal	20/60	0.17	DX02-611-951M DX01-611-951M
	01 - 26 mm	Vented center	Self centering	20/60	0.21	

Solenoid operated ISO valve fitted with adaptor to accept 15 mm solenoid

Solenoid plug/connector to be ordered separately.

Symbol	Size	Actuation	Return	Changeover time (ms) at 6 bar actua./return	Weight kg	Order code
5/2 Valves						
	02 - 18 mm	Electrical signal	Spring	15/25	0.9	DX02-621-60 DX01-621-60
	01 - 26 mm	Electrical signal	Spring	25/35	0.13	
	02 - 18 mm	Electrical signal	Differential	15/30	0.9	DX02-651-60 DX01-651-60
	01 - 26 mm	Electrical signal	Differential	20/40	0.13	
	02 - 18 mm	Electrical signal	Electrical signal	12/12	0.9	DX02-606-60 DX01-606-60
	01 - 26 mm	Electrical signal	Electrical signal	15/15	0.13	
5/3 Valves						
	02 - 18 mm	Electrical signal	Electrical signal	20/60	0.9	DX02-616-60 DX01-616-60
	01 - 26 mm	Closed center	Self centering	20/60	0.13	
	02 - 18 mm	Electrical signal	Electrical signal	20/60	0.9	DX02-611-60 DX01-611-60
	01 - 26 mm	Vented center	Self centering	20/60	0.13	

Pneumatic operated ISO valve

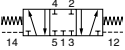
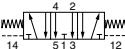
Symbol	Size	Actuation	Return	Changeover time (ms) at 6 bar actua./return	Weight kg	Order code
5/2 Valves						
	02 - 18 mm	Air signal	Spring	15/25	0.9	DX02-421-60
	01 - 26 mm	Air signal	Spring	25/35	0.13	DX01-421-60
	02 - 18 mm	Air signal	Differential	15/30	0.9	DX02-451-60
	01 - 26 mm	Air signal	Differential	20/40	0.13	DX01-451-60
	02 - 18 mm	Air signal	Air signal	12/12	0.9	DX02-406-60
	01 - 26 mm	Air signal	Air signal	14/14	0.13	DX01-406-60
5/3 Valves						
	02 - 18 mm	Air signal	Air signal	20/50	0.9	DX02-416-60
	01 - 26 mm	Closed center	Self centering	20/50	0.13	DX01-416-60
	02 - 18 mm	Air signal	Air signal	20/50	0.9	DX02-411-60
	01 - 26 mm	Vented center	Self centering	20/50	0.13	DX01-411-60

Isomax - ISO 5599 - Size 1 / 2 / 3 - CNOMO

Order chart

A

DX	1	-	6	51	-	B	L	49
-----------	----------	----------	----------	-----------	----------	----------	----------	-----------

Size	
1	Size 1 (ISO 5599)
2	Size 2 (ISO 5599)
3	Size 3 (ISO 5599)

Pilot	
4	Pneumatic
6	Electro-Pneumatic

Valve type function	
Internal pilot supply	
06	5/2 double solenoid
56	5/2 double solenoid, 14 prioritised
21	5/2 single solenoid, spring return
51	5/2 single solenoid, differential return
11	5/3 double solenoid vented centre
16	5/3 double solenoid closed centre
13	5/3 double solenoid pressurised center
External pilot 14 supply	
05	5/2 double solenoid
59	5/2 double solenoid, 14 prioritised
23	5/2 single solenoid, spring return
54	5/2 single solenoid, differential return
09	5/3 double solenoid vented centre
19	5/3 double solenoid closed centre
14	5/3 double solenoid pressurised center

Voltage		
	DC	AC
45	12	
49	24	
40		12
42		24
53		110
57		230
Blank	Valve less coil	

Shaded voltage part numbers are available from stock.
 Unshaded part numbers are available on request but will be subject to minimum order quantities.
 Otherwise order coil/solenoid and valve separately.

Solenoid enclosure	
2*	Central M12 connection
6*	M12 on each coil
L	3 pin 30mm DIN 43650A
P	3 pin Industrial form B
N	Valve less coil

*19 for M12 coil

Overrides	
60	Remote pilot / without solenoid
70	Remote pilot / without solenoid *
A	No override
B	Non-locking (single sol.) Flush - Metal
C	Locking (double sol.) Flush - Plastic

* Fitted with direct spool override.







Shaded part numbers are standard



Isomax







Solenoid operated ISO valve fitted with CNOMO solenoid(s) 24 VDC

Solenoid plug/connector to be ordered separately.

Symbol	Size	Actuation	Return	Changeover time (ms) at 6 bar actua./return	Weight kg	Order code
5/2 Valves						
	1 - 43mm	Electrical signal	Spring	40/55	0.5	DX1-621-BL49
	2 - 56mm	Electrical signal	Spring	60/105	0.75	DX2-621-BL49
	3 - 71mm	Electrical signal	Spring	85/160	1.25	DX3-621-BL49
	1 - 43mm	Electrical signal	Differential	30/70	0.5	DX1-651-BL49
	2 - 56mm	Electrical signal	Differential	55/110	0.75	DX2-651-BL49
	3 - 71mm	Electrical signal	Differential	80/180	1.25	DX3-651-BL49
	1 - 43mm	Electrical signal	Electrical signal	25/25	0.65	DX1-606-BL49
	2 - 56mm	Electrical signal	Electrical signal	30/30	0.9	DX2-606-BL49
	3 - 71mm	Electrical signal	Electrical signal	40/40	1.4	DX3-606-BL49
5/3 Valves						
	1 - 43mm	Electrical signal	Electrical signal	30/95	0.65	DX1-616-BL49
	2 - 56mm	Closed center	Self centering	40/190	0.9	DX2-616-BL49
	3 - 71mm			55/330	1.4	DX3-616-BL49
	1 - 43mm	Electrical signal	Electrical signal	25/70	0.65	DX1-611-BL49
	2 - 56mm	Vented center	Self centering	40/140	0.9	DX2-611-BL49
	3 - 71mm			60/270	1.4	DX3-611-BL49
	1 - 43mm	Electrical signal	Electrical signal	25/65	0.65	DX1-613-BL49
	2 - 56mm	Press. center	Self centering	40/150	0.9	DX2-613-BL49





Solenoid operated ISO valve fitted with CNOMO operator without coil

Solenoid plug/connector to be ordered separately.

Symbol	Size	Actuation	Return	Changeover time (ms) at 6 bar actua./return	Weight kg	Order code
5/2 Valves						
	1 - 43mm	Electrical signal	Spring	40/55	0.4	DX1-621-BN
	2 - 56mm	Electrical signal	Spring	60/105	0.65	DX2-621-BN
	3 - 71mm	Electrical signal	Spring	85/160	1.15	DX3-621-BN
	1 - 43mm	Electrical signal	Differential	30/70	0.4	DX1-651-BN
	2 - 56mm	Electrical signal	Differential	55/110	0.65	DX2-651-BN
	3 - 71mm	Electrical signal	Differential	80/180	1.15	DX3-651-BN
	1 - 43mm	Electrical signal	Electrical signal	25/25	0.55	DX1-606-BN
	2 - 56mm	Electrical signal	Electrical signal	30/30	0.8	DX2-606-BN
	3 - 71mm	Electrical signal	Electrical signal	40/40	1.3	DX3-606-BN
5/3 Valves						
	1 - 43mm	Electrical signal	Electrical signal	30/95	0.55	DX1-616-BN
	2 - 56mm	Closed center	Self centering	40/190	0.8	DX2-616-BN
	3 - 71mm			55/330	1.3	DX3-616-BN
	1 - 43mm	Electrical signal	Electrical signal	25/70	0.55	DX1-611-BN
	2 - 56mm	Vented center	Self centering	40/140	0.8	DX2-611-BN
	3 - 71mm			60/270	1.3	DX3-611-BN
	1 - 43mm	Electrical signal	Electrical signal	25/65	0.55	DX1-613-BN
	2 - 56mm	Press. center	Self centering	40/150	0.8	DX2-613-BN

Pneumatic operated ISO valve without valve spool override

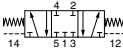



A

Symbol	Size	Actuation	Return	Changeover time (ms) at 6 bar actua./return	Weight kg	Order code
5/2 Valves						
	1 - 43mm	Air signal	Spring	30/45	0.35	DX1-421-60
	2 - 56mm	Air signal	Spring	50/95	0.6	DX2-421-60
	3 - 71mm	Air signal	Spring	80/160	1.1	DX3-421-60
	1 - 43mm	Air signal	Differential	25/60	0.35	DX1-451-60
	2 - 56mm	Air signal	Differential	45/100	0.6	DX2-451-60
	3 - 71mm	Air signal	Differential	70/170	1.1	DX3-451-60
	1 - 43mm	Air signal	Air signal	20/20	0.35	DX1-406-60
	2 - 56mm	Air signal	Air signal	25/25	0.6	DX2-406-60
	3 - 71mm	Air signal	Air signal	35/35	1.1	DX3-406-60
5/3 Valves						
	1 - 43mm	Air signal	Air signal	20/80	0.35	DX1-416-60
	2 - 56mm	Closed center	Self centering	30/170	0.6	DX2-416-60
	3 - 71mm			45/330	1.1	DX3-416-60
	1 - 43mm	Air signal	Air signal	20/65	0.35	DX1-411-60
	2 - 56mm	Vented center	Self centering	30/140	0.6	DX2-411-60
	3 - 71mm			50/270	1.1	DX3-411-60
	1 - 43mm	Air signal	Air signal	20/60	0.35	DX1-413-60
	2 - 56mm	Press. center	Self centering	25/140	0.6	DX2-413-60

Solenoid operated ISO valve, CNOMO, 24 VDC with M12 coil



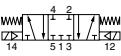

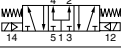
M12 connection is integrated on the coil, Led & surge suppressor

A

Symbol	Size	Actuation	Return	Changeover time (ms) at 6 bar actua./return	Weight kg	Order code
5/2 Valves						
	1 - 43mm	Electrical signal	Spring	40/55	0.5	DX1-621-B619
	2 - 56mm	Electrical signal	Spring	60/105	0.75	DX2-621-B619
	3 - 71mm	Electrical signal	Spring	85/160	1.25	DX3-621-B619
	1 - 43mm	Electrical signal	Differential	30/70	0.5	DX1-651-B619
	2 - 56mm	Electrical signal	Differential	55/110	0.75	DX2-651-B619
	3 - 71mm	Electrical signal	Differential	80/180	1.25	DX3-651-B619
	1 - 43mm	Electrical signal	Electrical signal	25/25	0.65	DX1-606-B619
	2 - 56mm	Electrical signal	Electrical signal	30/30	0.9	DX2-606-B619
	3 - 71mm	Electrical signal	Electrical signal	40/40	1.4	DX3-606-B619
5/3 Valves						
	1 - 43mm	Electrical signal	Electrical signal	30/95	0.65	DX1-616-B619
	2 - 56mm	Closed center	Self centering	40/190	0.9	DX2-616-B619
	3 - 71mm			55/330	1.4	DX3-616-B619
	1 - 43mm	Electrical signal	Electrical signal	25/70	0.65	DX1-611-B619
	2 - 56mm	Vented center	Self centering	40/140	0.9	DX2-611-B619
	3 - 71mm			60/270	1.4	DX3-611-B619
	1 - 43mm	Electrical signal	Electrical signal	25/65	0.65	DX1-613-B619
	2 - 56mm	Press. center	Self centering	40/150	0.9	DX2-613-B619

Solenoid operated ISO valve, CNOMO, 24 VDC with Din A coil and M12 connector

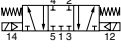
M12 connection is made with an adaptor between coils, Led & surge suppressor

Symbol	Size	Actuation	Return	Changeover time (ms) at 6 bar actua./return	Weight kg	Order code
5/2 Valves						
	1 - 43mm	Electrical signal	Spring	40/55	0.65	DX1-621-B219
	2 - 56mm	Electrical signal	Spring	60/105	0.9	DX2-621-B219
	3 - 71mm	Electrical signal	Spring	85/160	1.4	DX3-621-B219
	1 - 43mm	Electrical signal	Differential	30/70	0.65	DX1-651-B219
	2 - 56mm	Electrical signal	Differential	55/110	0.9	DX2-651-B219
	3 - 71mm	Electrical signal	Differential	80/180	1.4	DX3-651-B219
	1 - 43mm	Electrical signal	Electrical signal	25/25	0.8	DX1-606-B219
	2 - 56mm	Electrical signal	Electrical signal	30/30	1.05	DX2-606-B219
	3 - 71mm	Electrical signal	Electrical signal	40/40	1.55	DX3-606-B219
5/3 Valves						
	1 - 43mm	Electrical signal	Electrical signal	30/95	0.8	DX1-616-B219
	2 - 56mm	Closed center	Self centering	40/190	1.05	DX2-616-B219
	3 - 71mm			55/330	1.55	DX3-616-B219
	1 - 43mm	Electrical signal	Electrical signal	25/70	0.8	DX1-611-B219
	2 - 56mm	Vented center	Self centering	40/140	1.05	DX2-611-B219
	3 - 71mm			60/270	1.55	DX3-611-B219
	1 - 43mm	Electrical signal	Electrical signal	25/65	0.8	DX1-613-B219
	2 - 56mm	Press. center	Self centering	40/150	1.05	DX2-613-B219

ISYS ISO - Heavy Duty Applications

Market Applications

- Automotive
- Machine tools
- Mobile



B

- **Excellent reliability :**

Long life in excess of 30 million operations.

- **Heavy Duty Metal Body**

- **Stable long lasting performances :**

due to wear compensation

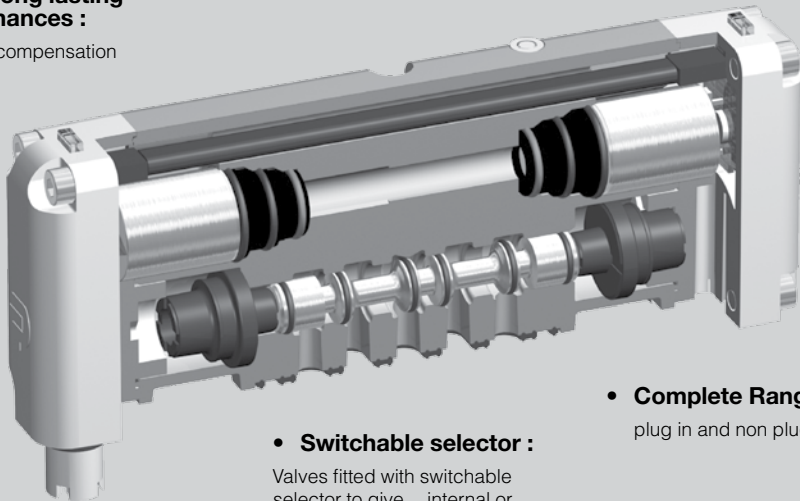

- **Complete Range :**

plug in and non plug in

- **Switchable selector :**

Valves fitted with switchable selector to give internal or external pilot supply

- **WCS Spool Technology**



ISYS ISO Features

Complete ISO valve range

ISO 15407-1, ISO 15407-2, ISO 5599-1, ISO 5599-2, ISO 4400 DIN A, 12mm, 23 mm, multipole and centralized fieldbus are all feature of ISYS ISO valve.

Heavy duty and corrosion resistant body

with a valve body made of painted die casted aluminium and polyamide reinforced glassfiber caps, Isys Iso are suitable for heavy duty environment

External supply selection

In order to use actuator with low pressure, it is possible to connect an external pressure on port 14 to supply both solenoids. Selection is easily made by reversing the gasket under the operator.

High reliability



Valves comply with the requirements for the component reliability in accordance with EU Machinery Directive standards EN292-2 and EN983.

Mobile applications

ISYS ISO range could be fit with a metal mobile CNOMO solenoid. Available with different coil voltages, allowing +/- 30% voltage tolerance, operating from -15°C to 50°C, under demanding vibration and shock condition, ISYS ISO is suitable for mobile and railway applications.

Solenoid valves, CNOMO interface, integrated solenoid



The standard valve is fitted with a 30mm solenoid having DIN 43650 Industrial form A connector for sizes 1, 2 and 3. For sizes 01 and 02, the solenoid is integrated in the valve body.

Central M12 & M23 connection or M12 coil

Sizes 01 & 02 are available with a central M12 connection
 Sizes 1, 2 & 3 are available with a central M12 or M23 connector, compatible with differents automotive standard, but also with 30x30 coil having the M12 connection.

Internal or external led & rectifier

Sizes 01 & 02 have integrated Led and rectifier, for all connections. Sizes 1,2, 3 are available with integrated Led and rectifier in the coil or basic Din A coil.

High electrical encapsulation class

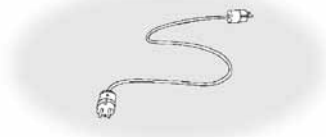

The solenoid valves are protected to IP65 with the standard cable plug. Available with DIN A or M12 connection.

Wide range of solenoid connectors / cable plugs for ISO 5599-1

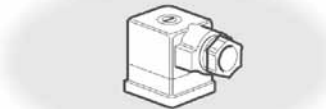

Solenoid connectors are available with or without LED and rectifier and may be selected fitted pre-wired with flying leads.

Bottom or side ported manifolds and subbases

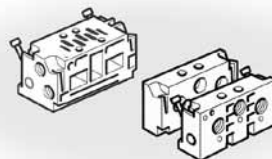

Manifolds are common for ISO 15407-1 & ISO 5599-1. A dedicated range of manifold is available for ISYS ISO with integrated electrical connection in the base (plug in)

Insensitive to dirty air

Thanks to large flow passage areas and the large flow diameter of 1.3 in the pilot valves, the ISO valve can be used in normal industrial or mobile environments without any problems of blocking. However the service life of the valve depends on the cleanliness of the air. Please refer to ISO 8573.

ISYS ISO - Features

Serial communication

ISYSNET provides an open communications protocol with a common platform that is compatible with all ISO valves. ISYSNET allows connecting with Ethernet IP, Profibus DP, ControlNet, and DeviceNet. The communication modules are IP65 protected and can be easily replaced by using latching mechanisms that eliminate the need for screws. DIP and rotary switches come standard, as well as electrical connection. A total of 63 Input / Output modules can be assembled with a single communication module node. Both digital (M8, M12, and M23 connection) and analog (current or voltage) Inputs / Outputs modules are available. Sinking (NPN) or sourcing (PNP) modules complete the connectivity solution. Built in Diagnostic, such as open circuit, no-load, and short-circuit detection, simplify maintenance. The modules also have overvoltage protection and reverse-polarity protection.

Collective wiring

There are no wires between connectors and base circuit boards. Circuit boards make all connections throughout the manifold, decreasing opportunities for electrical failures due to loose wire. Plate cover for collective wiring have an IP65 rating. Main connector available on left end module are :

- 25 pin D-Sub connector allowing 24 solenoids
- 19 pin Brad Harrison round connector allowing 16 solenoids
- 12 pin M23 round connector allowing 8 solenoids
- 16 Point terminal strip, allowing 16 solenoids
- ISYS NET module, 32 outputs, allowing 32 solenoids

Hard wiring

In case of 110 or 230 VAC standard voltage, or for a small number of valve on the manifold, specially for sizes 2 & 3, hard wiring could be preferred. This method requires wiring each valve through a simple cable or a screw terminal.

ISO 15407-2 manifolds

Using ISO 15407 standards as foundation, the Isys line leapfrogs proprietary valves to install 18 and 26 mm valves within the same manifold.

Manifold bases are available in two-station multiple.

Two-station manifolds increase rigidity for longer manifolds and decrease the number of base to base electrical and pneumatic connections, reducing the potential for leaks and electrical misconnections. Cylinder ports are available with BSPP, NPT in inch sizes.

Manifold bases are available with side or side and bottom ported.

Oversize ports for ISO 5599-2 manifolds

Due to the standardized size of bases and valve, the resulting flow is limited by port size. All manifold for size 1, 2, and 3 are available with oversize port to optimise the flow for size. As an example, size 1 valve and manifold, equipped with a 3/8 port is suitable with a 100mm diameter cylinder where a size 2 valve will have been chosen.

This is all the more true than the cylinder speed is limited with flow control and adjusted near 0,5m/s

B

ISYS ISO Flow Characteristics

Flow capacities in accordance with ISO6358, for 5/2 function. 5/3 function are around 10 to 20% less

B

Technical Data ISYS ISO Size 02

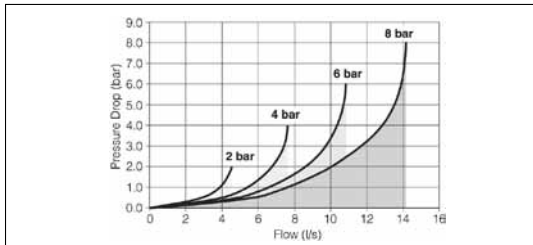

Operating pressure.

5/2 Spring return	2,0 - 10 bar
5/2 Differential	2,0 - 10 bar
5/2 Double solenoid	2,0 - 10 bar
5/3 Double solenoid	2,5 - 10 bar

Working temperature.
Flow (acc. to ISO 6358)

-15°C to + 50°C
$c = 1,5 \text{ NI/s} \times \text{bar}$
$b = 0,25$
$Q_n = 6,5 \text{ l/s}$
$Q_{max} = 10,8 \text{ l/s}$

Technical Data ISYS ISO Size 01

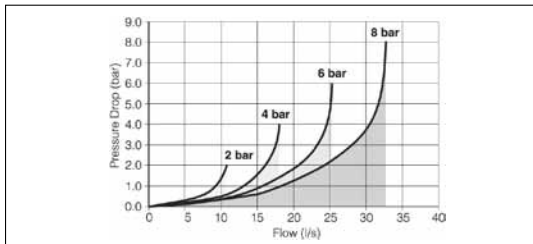

Operating pressure.

5/2 Spring return	2,0 - 10 bar
5/2 Differential	1,7 - 10 bar
5/2 Double solenoid	1,7 - 10 bar
5/3 Double solenoid	2,5 - 10 bar

Working temperature.
Flow (acc. to ISO 6358)

-15°C to + 50°C
$c = 3,6 \text{ NI/s} \times \text{bar}$
$b = 0,30$
$Q_n = 15,3 \text{ l/s}$
$Q_{max} = 25,3 \text{ l/s}$

Technical Data ISYS ISO Size 1

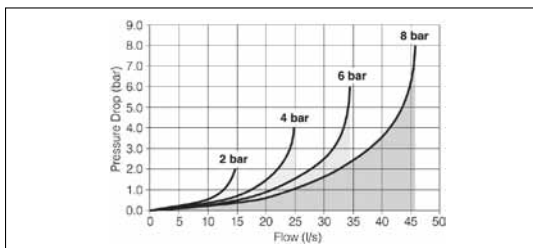

Operating pressure.

5/2 Spring return	2,4 - 10 bar
5/2 Differential	1,7 - 10 bar
5/2 Double solenoid	1,7 - 10 bar
5/3 Double solenoid	2,5 - 10 bar

Working temperature.
Flow (acc. to ISO 6358)

-15°C to + 50°C
$c = 5,0 \text{ NI/s} \times \text{bar}$
$b = 0,30$
$Q_n = 20,8 \text{ l/s}$
$Q_{max} = 34,5 \text{ l/s}$

Technical Data ISYS ISO Size 2

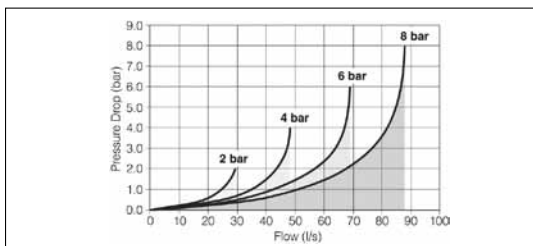

Operating pressure.

5/2 Spring return	3,1 - 10 bar
5/2 Differential	1,7 - 10 bar
5/2 Double solenoid	1,7 - 10 bar
5/3 Double solenoid	3,5 - 10 bar

Working temperature.
Flow (acc. to ISO 6358)

-15°C to + 50°C
$c = 9,7 \text{ NI/s} \times \text{bar}$
$b = 0,35$
$Q_n = 42,0 \text{ l/s}$
$Q_{max} = 69,0 \text{ l/s}$

Technical Data ISYS ISO Size 3

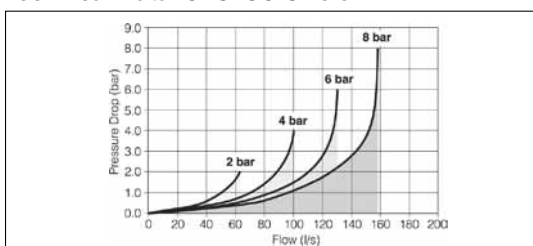

Operating pressure.

5/2 Spring return	3,1 - 10 bar
5/2 Differential	2,5 - 10 bar
5/2 Double solenoid	2,5 - 10 bar
5/3 Double solenoid	3,5 - 10 bar

Working temperature.
Flow (acc. to ISO 6358)

-15°C to + 50°C
$c = 18,7 \text{ NI/s} \times \text{bar}$
$b = 0,35$
$Q_n = 83,7 \text{ l/s}$
$Q_{max} = 130,8 \text{ l/s}$

ISYS ISO Material Specification and Characteristics

Material specification

Valve body:	Die cast aluminium
End cover:	PBT
Spool:	Aluminium + nitrile rubber
Piston:	Acetal plastic
End cover sealing:	Nitrile rubber
Fasteners:	Zinc plated steel

HA & HB Solenoids

Minimum operating voltage:	DC 20,4 V, AC 102 V
Power:	DC 1W, AC 2VA
Bi polar:	
Surge suppressor:	Standard
Light indicator:	Standard

B

Characteristics

Fluid:	Air, inert gas filtered 40u class 5 according to ISO 8573-1 dry class 4 according to ISO 8573-1 non-lubricated, or lubricated -20° to + 70°
Storage temperature	
Vibration, according to IEC 68-2-6	2G 2 to 150Hz
Shock, according to IEC 68-2-7	15G 11ms
Manual override	Non-locking, other type on request

Plug-in Solenoids

Minimum operating voltage:	DC 20,4 V, AC 102 V
Power:	DC 3W, AC 4,5VA
Bi polar:	
Surge suppressor:	On lighted coils
Light indicator:	Standard

Certification

CSA / C-US approved	
EMC / CE mark.	According to EN 61 000-6-2
Dust & water protection	IP65 according to EN 60529

ISYS ISO M12 and Pilot

Order chart

B

H B 1 WX B G 2 G9 000F A

Size	
B	ISO 15407 - 18mm
A	ISO 15407 - 26mm

Pilot source / Pilot exhaust	
B	Internal pilot, port#1 / vented
L	External pilot#14 port / vented

Voltage	
	DC
G9	24

2	Central M12
---	-------------

Valve type function	
1	Single solenoid, 2 position - Differential
2	Double solenoid, 2 position
5	Double solenoid, 3 position - APB
6	Double solenoid, 3 position - CE
7	Double solenoid, 3 position - PC
E	Single solenoid, 2 position, Differential, spring assist

Overrides	
G	Non-locking, flush, push - w/ light
H	Locking, flush, push / turn - w/ light

Shaded voltage part numbers are available from stock. Unshaded part numbers are available on request but will be subject to minimum order quantities. Otherwise order coil/solenoid and valve separately.

Shaded part numbers are standard

ISYS ISO

ISYS ISO Remote Pilot

Order chart

H B 3 WX 000 XX A

Size	
B	ISO 15407 - 18mm
A	ISO 15407 - 26mm





Valve type function	
3	Single remote pilot, 2 position - Differential
4	Double remote pilot, 2 position
8	Double remote pilot, 3 position - APB
9	Double remote pilot, 3 position - CE
0	Double remote pilot, 3 position - PC
F	Single solenoid, 2 position, Differential, spring assist

Shaded part numbers are standard



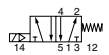
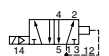

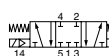
ISYS ISO

Solenoid operated ISO valve, 24 VDC, central M12 connection

Oriented side 14, Led & surge suppressor

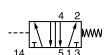
Symbol	Size	Actuation	Return	Changeover time (ms) at 6 bar actua./return	Weight kg	Order code
5/2 Valves						
	02 - 18mm 01 - 26mm	Electrical signal Electrical signal	Spring & Diff. Spring & Diff.	20/40 20/45	0.15 0.25	HBEWXBG2G9000FA HAEWXBG2G9000FA
	02 - 18mm 01 - 26mm	Electrical signal Electrical signal	Differential Differential	15/40 15/50	0.15 0.25	HB1WXBG2G9000FA HA1WXBG2G9000FA
	02 - 18mm 01 - 26mm	Electrical signal Electrical signal	Electrical signal Electrical signal	10 10	0.165 0.265	HB2WXBG2G9000FA HA2WXBG2G9000FA
5/3 Valves						
	02 - 18mm 01 - 26mm	Electrical signal Closed center	Electrical signal Self centering	15/60 15/50	0.165 0.265	HB5WXBG2G9000FA HA5WXBG2G9000FA
	02 - 18mm 01 - 26mm	Electrical signal Vented center	Electrical signal Self centering	15/60 15/50	0.165 0.265	HB6WXBG2G9000FA HA6WXBG2G9000FA
	02 - 18mm 01 - 26mm	Electrical signal Press. center	Electrical signal Self centering	15/60 15/50	0.165 0.265	HB7WXBG2G9000FA HA7WXBG2G9000FA

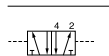
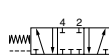
Pneumatic operated ISO valve

Symbol	Size	Actuation	Return	Changeover time (ms) at 6 bar actua./return	Weight kg	Order code
5/2 Valves						
	02 - 18mm 01 - 26mm	Air signal Air signal	Spring & Diff. Spring & Diff.	15/30 15/40	0.115 0.215	HBFWX000XXA HAFWX000XXA
	02 - 18mm 01 - 26mm	Air signal Air signal	Differential Differential	10/30 15/35	0.115 0.215	HB3WX000XXA HA3WX000XXA
	02 - 18mm 01 - 26mm	Air signal Air signal	Air signal Air signal	8 10	0.115 0.215	HB4WX000XXA HA4WX000XXA
5/3 Valves						
	02 - 18mm 01 - 26mm	Air signal Closed center	Air signal Self centering	15/35 15/40	0.115 0.215	HB8WX000XXA HA8WX000XXA
	02 - 18mm 01 - 26mm	Air signal Vented center	Air signal Self centering	15/35 15/40	0.115 0.215	HB9WX000XXA HA9WX000XXA
	02 - 18mm 01 - 26mm	Air signal Press. center	Air signal Self centering	15/35 15/40	0.115 0.215	HB0WX000XXA HA0WX000XXA

 Indicates stocked product.

ISYS ISO Plug in

Order chart

B

H
B
1
VX
B
G
0
G9
A

Size	
B	ISO 15407 - 18mm
A	ISO 15407 - 26mm

Pilot source / Pilot exhaust	
B	Internal pilot, port#1 / vented
L	External pilot#14 port / vented

Voltage	
G9	24 VDC
23	115 VAC

Valve type function	
1	Single solenoid, 2 position - Differential
2	Double solenoid, 2 position
5	Double solenoid, 3 position - APB
6	Double solenoid, 3 position - CE
7	Double solenoid, 3 position - PC
E	Single solenoid, 2 position, Air return, spring assist

Overrides	
G	Non-locking, flush, push - w/ light
H	Locking, flush, push / turn - w/ light

* Only available with pilot source / pilot exhaust 'O'. Available on HA only, must use DX01 manifold or HA subbase

Shaded part numbers are standard





ISYS ISO

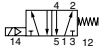
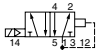

Shaded voltage part numbers are available from stock. Unshaded part numbers are available on request but will be subject to minimum order quantities. Otherwise order coil/solenoid and valve separately.

Solenoid operated ISO plug-in valve, 24 VDC

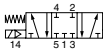
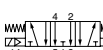
Manual override non locking, Led & surge suppressor

Symbol	Size	Actuation	Return	Changeover time (ms) at 6 bar actua./return	Weight kg	Order code
5/2 Valves						
	02 - 18mm 01 - 26mm	Electrical signal Electrical signal	Spring & Diff. Spring & Diff.	20/40 20/45	0.13 0.23	HBEVXBG0G9A HAEVXBG0G9A
	02 - 18mm 01 - 26mm	Electrical signal Electrical signal	Differential Differential	15/40 15/50	0.13 0.23	HB1VXBG0G9A HA1VXBG0G9A
	02 - 18mm 01 - 26mm	Electrical signal Electrical signal	Electrical signal Electrical signal	10 10	0.145 0.245	HB2VXBG0G9A HA2VXBG0G9A
5/3 Valves						
	02 - 18mm 01 - 26mm	Electrical signal Closed center	Electrical signal Self centering	15/60 15/50	0.145 0.245	HB5VXBG0G9A HA5VXBG0G9A
	02 - 18mm 01 - 26mm	Electrical signal Vented center	Electrical signal Self centering	15/60 15/50	0.145 0.245	HB6VXBG0G9A HA6VXBG0G9A
	02 - 18mm 01 - 26mm	Electrical signal Press. center	Electrical signal Self centering	15/60 15/50	0.145 0.245	HB7VXBG0G9A HA7VXBG0G9A

ISYS ISO - ISO 5599-1 - CNOMO - Size 1 / 2 / 3

Order chart

B

H
1
E
WX
B
B
L
49
C

Size	
1	ISO 5599-1 - Size 1
2	ISO 5599-1 - Size 2
3	ISO 5599-1 - Size 3

Pilot source / Pilot exhaust	
B	Internal pilot#1 port / vented
X*	External pilot#12 or #14 port / vented

* Must be specified when using Sandwich regulators

Voltage	
42	24 VAC
49	24 VDC
53	120 VAC
57	230 VAC
XX	Valve less coil

Shaded voltage part numbers are available from stock. Unshaded part numbers are available on request but will be subject to minimum order quantities. Otherwise order coil/solenoid and valve separately.

Valve type function	
1	Single solenoid, 2 position - Differential
2	Double solenoid, 2 position
5	Double solenoid, 3 position - APB
6	Double solenoid, 3 position - CE
7	Double solenoid, 3 position - PC
E	Single solenoid, 2 position, Differential, spring assist

Enclosure / Lead lengths	
L	3-pin 30mm DIN 43650A with CNOMO operator
N	Valve less coil

Overrides / Lights	
B	Non-locking, flush, push - w/o light
C	Locking, flush, push / turn - w/o light

Shaded part numbers are standard

ISYS ISO

Solenoid operated ISO valve fitted with CNOMO solenoid(s) 24 VDC

solenoid plug/connector to be ordered separately.

Symbol	Size	Actuation	Return	Changeover time (ms) at 6 bar actua./return	Weight kg	Order code
5/2 Valves						
	1 - 43mm	Electrical signal	Spring & Diff.	25/35	0.77	H1EWXBBL49C
	2 - 56mm	Electrical signal	Spring & Diff.	40/70	1.19	H2EWXBBL49C
	3 - 71mm	Electrical signal	Spring & Diff.	70/80	1.47	H3EWXBBL49C
	1 - 43mm	Electrical signal	Differential	25/45	0.77	H11WXBBL49C
	2 - 56mm	Electrical signal	Differential	35/80	1.19	H21WXBBL49C
	3 - 71mm	Electrical signal	Differential	55/85	1.47	H31WXBBL49C
	1 - 43mm	Electrical signal	Electrical signal	15	0.94	H12WXBBL49C
	2 - 56mm	Electrical signal	Electrical signal	20	1.36	H22WXBBL49C
	3 - 71mm	Electrical signal	Electrical signal	25	1.64	H32WXBBL49C
5/3 Valves						
	1 - 43mm	Electrical signal	Electrical signal	15/60	0.94	H15WXBBL49C
	2 - 56mm	Closed center	Self centering	30/75	1.36	H25WXBBL49C
	3 - 71mm			23/80	1.64	H35WXBBL49C
	1 - 43mm	Electrical signal	Electrical signal	15/60	0.94	H16WXBBL49C
	2 - 56mm	Vented center	Self centering	30/75	1.36	H26WXBBL49C
	3 - 71mm			23/80	1.64	H36WXBBL49C
	1 - 43mm	Electrical signal	Electrical signal	15/60	0.94	H17WXBBL49C
	2 - 56mm	Press. center	Self centering	30/75	1.36	H27WXBBL49C
	3 - 71mm			23/80	1.64	H37WXBBL49C

Solenoid operated ISO valve fitted with CNOMO operator without coil

Coils and plug/connector should be ordered separately.

Symbol	Size	Actuation	Return	Changeover time (ms) at 6 bar actua./return	Weight kg	Order code
5/2 Valves						
	1 - 43mm	Electrical signal	Spring & Diff.	25/35	0.65	H1EWXBPNXXC
	2 - 56mm	Electrical signal	Spring & Diff.	40/70	1.07	H2EWXBPNXXC
	3 - 71mm	Electrical signal	Spring & Diff.	70/80	1.35	H3EWXBPNXXC
	1 - 43mm	Electrical signal	Differential	25/45	0.65	H11WXBPNXXC
	2 - 56mm	Electrical signal	Differential	35/80	1.07	H21WXBPNXXC
	3 - 71mm	Electrical signal	Differential	55/85	1.35	H31WXBPNXXC
	1 - 43mm	Electrical signal	Electrical signal	15	0.7	H12WXBPNXXC
	2 - 56mm	Electrical signal	Electrical signal	20	1.12	H22WXBPNXXC
	3 - 71mm	Electrical signal	Electrical signal	25	1.4	H32WXBPNXXC
5/3 Valves						
	1 - 43mm	Electrical signal	Electrical signal	15/60	0.7	H15WXBPNXXC
	2 - 56mm	Closed center	Self centering	30/75	1.12	H25WXBPNXXC
	3 - 71mm			23/80	1.4	H35WXBPNXXC
	1 - 43mm	Electrical signal	Electrical signal	15/60	0.7	H16WXBPNXXC
	2 - 56mm	Vented center	Self centering	30/75	1.12	H26WXBPNXXC
	3 - 71mm			23/80	1.4	H36WXBPNXXC
	1 - 43mm	Electrical signal	Electrical signal	15/60	0.7	H17WXBPNXXC
	2 - 56mm	Press. center	Self centering	30/75	1.12	H27WXBPNXXC
	3 - 71mm			23/80	1.4	H37WXBPNXXC

ISYS ISO 5599-1 Size 1 / 2 / 3 Central Connection

Order chart

B

H 1 E WX B G 2 B9 000 F C

Size	
1	ISO 5599-1 - Size 1
2	ISO 5599-1 - Size 2
3	ISO 5599-1 - Size 3

Pilot source / Pilot exhaust	
B	Internal pilot#1 port / vented
X*	External pilot#12 port / vented

* Must be specified when using Sandwich regulators

Wiring options	
F	Standard

Enclosure / Voltage	
2B9	4-pin M12 Connector 24 VDC
619	2-pin M12 on coil 24 VDC

Valve type function	
1	Single solenoid, 2 position - Differential
2	Double solenoid, 2 position
5	Double solenoid, 3 position - APB
6	Double solenoid, 3 position - CE
7	Double solenoid, 3 position - PC
E	Single solenoid, 2 position, Differential, spring assist

Overrides / Lights	
G	Non-locking, flush, push - w/ light
H	Locking, flush, push / turn - w/ light

Shaded part numbers are standard



ISYS ISO 5599-1 Size 1 / 2 / 3 Remote Pilot

Order chart

H 1 F WX 000 XX C

Size	
1	ISO 5599-1 - Size 1
2	ISO 5599-1 - Size 2
3	ISO 5599-1 - Size 3

Valve type function	
3	Single remote pilot, 2 position - Differential
4	Double remote pilot, 2 position
8	Double remote pilot, 3 position - APB
9	Double remote pilot, 3 position - CE
0	Double remote pilot, 3 position - PC
F	Single remote pilot, 2 position, Differential, spring assist

Shaded part numbers are standard



Solenoid operated ISO valve, 24VDC, central M12 connection

Oriented side 14, Led & surge suppressor

Symbol	Size	Actuation	Return	Changeover time (ms) at 6 bar actua./return	Weight kg	Order code
5/2 Valves						
	1 - 43mm	Electrical signal	Spring & Diff.	30/40	0.77	H1EWXBG2B9000FC
	2 - 56mm	Electrical signal	Spring & Diff.	45/70	1.29	H2EWXBG2B9000FC
	3 - 71mm	Electrical signal	Spring & Diff.	75/80	1.57	H3EWXBG2B9000FC
	1 - 43mm	Electrical signal	Differential	30/50	0.77	H11WXBG2B9000FC
	2 - 56mm	Electrical signal	Differential	40/80	1.29	H21WXBG2B9000FC
	3 - 71mm	Electrical signal	Differential	60/85	1.57	H31WXBG2B9000FC
	1 - 43mm	Electrical signal	Electrical signal	20	1.04	H12WXBG2B9000FC
	2 - 56mm	Electrical signal	Electrical signal	25	1.46	H22WXBG2B9000FC
	3 - 71mm	Electrical signal	Electrical signal	30	1.74	H32WXBG2B9000FC
5/3 Valves						
	1 - 43mm	Electrical signal	Electrical signal	20/65	1.04	H15WXBG2B9000FC
	2 - 56mm	Closed center	Self centering	35/80	1.46	H25WXBG2B9000FC
	3 - 71mm			40/85	1.74	H35WXBG2B9000FC
	1 - 43mm	Electrical signal	Electrical signal	20/65	1.04	H16WXBG2B9000FC
	2 - 56mm	Vented center	Self centering	35/80	1.46	H26WXBG2B9000FC
	3 - 71mm			40/85	1.74	H36WXBG2B9000FC
	1 - 43mm	Electrical signal	Electrical signal	20/65	1.04	H17WXBG2B9000FC
	2 - 56mm	Press. center	Self centering	35/80	1.46	H27WXBG2B9000FC
	3 - 71mm			40/85	1.74	H37WXBG2B9000FC

Pneumatic operated ISO valve without manual override

Symbol	Size	Actuation	Return	Changeover time (ms) at 6 bar actua./return	Weight kg	Order code
5/2 Valves						
	1 - 43mm	Air signal	Spring & Diff.	20/30	0.6	H1FWX000XXC
	2 - 56mm	Air signal	Spring & Diff.	35/70	1.02	H2FWX000XXC
	3 - 71mm	Air signal	Spring & Diff.	65/75	1.3	H3FWX000XXC
	1 - 43mm	Air signal	Differential	20/40	0.6	H13WX000XXC
	2 - 56mm	Air signal	Differential	30/80	1.02	H23WX000XXC
	3 - 71mm	Air signal	Differential	50/85	1.3	H33WX000XXC
	1 - 43mm	Air signal	Air signal	12	0.6	H14WX000XXC
	2 - 56mm	Air signal	Air signal	16	1.02	H24WX000XXC
	3 - 71mm	Air signal	Air signal	20	1.3	H34WX000XXC
5/3 Valves						
	1 - 43mm	Air signal	Air signal	15/55	0.6	H18WX000XXC
	2 - 56mm	Closed center	Self centering	20/70	1.12	H28WX000XXC
	3 - 71mm			30/80	1.3	H38WX000XXC
	1 - 43mm	Air signal	Air signal	15/55	0.6	H19WX000XXC
	2 - 56mm	Vented center	Self centering	20/70	1.02	H29WX000XXC
	3 - 71mm			30/80	1.3	H39WX000XXC
	1 - 43mm	Air signal	Air signal	15/55	0.6	H10WX000XXC
	2 - 56mm	Press. center	Self centering	20/70	1.02	H20WX000XXC
	3 - 71mm			30/80	1.3	H30WX000XXC

ISYS ISO - 5599-2 - Size 1 / 2 / 3 - Plug in

Order chart

B

H **1** **E** **VX** **B** **G** **0** **B9** **C**

	Size
1	ISO 5599-2 - Size 1
2	ISO 5599-2 - Size 2
3	ISO 5599-2 - Size 3

	Pilot source / Pilot exhaust
B	Internal pilot#1 port / vented
X*	External pilot#12 or #14 port / vented

* Must be specified when using Sandwich regulators

Voltage & Frequency **				
	AC		DC	Light & surge sup
	60Hz	50Hz		
42				
45			12	
B9*			24	LED & Sup
23	120	115		LED & Sup
57	240			
XX	Valve less coil			

* Solenoid is blue

Valve type function	
1	Single solenoid, 2 position - Differential
2	Double solenoid, 2 position
5	Double solenoid, 3 position - APB
6	Double solenoid, 3 position - CE
7	Double solenoid, 3 position - PC
E	Single solenoid, 2 position, Differential, spring assist

* Only available with pilot source / pilot exhaust 'O'.

Enclosure	
0	Non, Valve with coil
N	Non, Valve less coil

Overrides / Lights	
B	Non-locking, flush, push - w/o light
C	Locking, flush, push / turn - w/o light
G	Non-locking, flush, push - with light
H	Locking, flush, push / turn - with light

Shaded part numbers are standard

** Shaded voltage part numbers are available from stock. Unshaded part numbers are available on request but will be subject to minimum order quantities. Otherwise order coil/solenoid and valve separately.



Solenoid operated ISO valve, 24VDC, Plug-in

Led & surge suppressor

Symbol	Size	Actuation	Return	Changeover time (ms) at 6 bar actua./return	Weight kg	Order code
5/2 Valves						
	1 - 43mm	Electrical signal	Spring & Diff.	30/40	0.77	H11EVXBG0B9C
	2 - 56mm	Electrical signal	Spring & Diff.	45/70	1.19	H21EVXBG0B9C
	3 - 71mm	Electrical signal	Spring & Diff.	75/80	1.47	H31EVXBG0B9C
	1 - 43mm	Electrical signal	Differential	30/50	0.77	H11VXBG0B9C
	2 - 56mm	Electrical signal	Differential	40/80	1.19	H21VXBG0B9C
	3 - 71mm	Electrical signal	Differential	60/85	1.47	H31VXBG0B9C
	1 - 43mm	Electrical signal	Electrical signal	20	0.94	H12VXBG0B9C
	2 - 56mm	Electrical signal	Electrical signal	25	1.36	H22VXBG0B9C
	3 - 71mm	Electrical signal	Electrical signal	30	1.64	H32VXBG0B9C
5/3 Valves						
	1 - 43mm	Electrical signal	Electrical signal	20/65	0.94	H15VXBG0B9C
	2 - 56mm	Closed center	Self centering	35/80	1.36	H25VXBG0B9C
	3 - 71mm			40/85	1.64	H35VXBG0B9C
	1 - 43mm	Electrical signal	Electrical signal	20/65	0.94	H16VXBG0B9C
	2 - 56mm	Vented center	Self centering	35/80	1.36	H26VXBG0B9C
	3 - 71mm			40/85	1.64	H36VXBG0B9C
	1 - 43mm	Electrical signal	Electrical signal	20/65	0.94	H17VXBG0B9C
	2 - 56mm	Press. center	Self centering	35/80	1.36	H27VXBG0B9C
	3 - 71mm			40/85	1.64	H37VXBG0B9C

Solenoid operated ISO valve, with plug in operator, without coil

coil have to be ordered separately

Symbol	Size	Actuation	Return	Changeover time (ms) at 6 bar actua./return	Weight kg	Order code
5/2 Valves						
	1 - 43mm	Electrical signal	Spring & Diff.	30/40	0.65	H11EVXBGNNXXC
	2 - 56mm	Electrical signal	Spring & Diff.	45/70	1.07	H21EVXBGNNXXC
	3 - 71mm	Electrical signal	Spring & Diff.	75/80	1.35	H31EVXBGNNXXC
	1 - 43mm	Electrical signal	Differential	30/50	0.65	H11VXBGNNXXC
	2 - 56mm	Electrical signal	Differential	40/80	1.07	H21VXBGNNXXC
	3 - 71mm	Electrical signal	Differential	60/85	1.35	H31VXBGNNXXC
	1 - 43mm	Electrical signal	Electrical signal	20	0.7	H12VXBGNNXXC
	2 - 56mm	Electrical signal	Electrical signal	25	1.12	H22VXBGNNXXC
	3 - 71mm	Electrical signal	Electrical signal	30	1.4	H32VXBGNNXXC
5/3 Valves						
	1 - 43mm	Electrical signal	Electrical signal	20/65	0.7	H15VXBGNNXXC
	2 - 56mm	Closed center	Self centering	35/80	1.12	H25VXBGNNXXC
	3 - 71mm			40/85	1.4	H35VXBGNNXXC
	1 - 43mm	Electrical signal	Electrical signal	20/65	0.7	H16VXBGNNXXC
	2 - 56mm	Vented center	Self centering	35/80	1.12	H26VXBGNNXXC
	3 - 71mm			40/85	1.4	H36VXBGNNXXC
	1 - 43mm	Electrical signal	Electrical signal	20/65	0.7	H17VXBGNNXXC
	2 - 56mm	Press. center	Self centering	35/80	1.12	H27VXBGNNXXC
	3 - 71mm			40/85	1.4	H37VXBGNNXXC

Side ported subbase

B

Description	Port size	Weight (kg)	Order code BSPP "G"	Order code NPT
 Individual subbase kit Subbase with side port	Size 02	G1/8	0.07	PL02-01-70 PL02-01-80
	Size 01	G1/4	0.12	PL01-02-70 PL01-02-80

Side ported manifold

Description	Port size	Weight (kg)	Order code BSPP "G"	Order code NPT
 Two station manifold base with side ports To suit valves with internal supply solenoid	Size 02	G1/8	0.14	PJLP02-201-70 PJLP02-201-80
	Size 01	G1/4	0.7	PJLP01-202-70 PJLP01-202-80
	Two station manifold base To suit pneumatic actuated valves			
Size 01	G1/4	0.73	PJL01-202-70	PJL01-202-80
End plate kit - for side ported two station manifold base				
Size 02	G1/4	0.15	PEJ02-02-70	PEJ02-02-80*
Size 01	G3/8	0.52	PEJ01-03-70	PEJ01-03-80**
* Use with PJLP02 ** Use with PJLP01 or PJL01 Gaskets and assembly hardware included.				

Accessories

Description	Weight (kg)	Order code
 Blanking plate	Size 02	0.04
	Size 01	0.05
Blanking plug (for subbase PJL)		
Size 02	0.01	D02BD0
Size 01	0.02	D01BD0
Bolt, washer and nut		
Size 02		DX02M2MB
Size 01		DX01M2MB

Bottom ported manifolds

Accessories	Designation	Weight (kg)	Order code (P2V-A, 18 mm)	Weight (kg)	Order code (P2V-B, 26 mm)
	<p>Multiple manifold Including seal, fitting screws and plugs. Ports 2, 4, and 14 are bottom-connected. Fit plugs as required to provide common supply of operating air and common exhausts for solenoid valves. Plug assembly instruction, see page 35.</p>	0,20	P2V-AM511NB	0,40	P2V-BM512NB
	<p>Multiple manifold Multiple manifold as above, but with the plugs fitted to suit use with valves with internal supply to solenoid.</p>	0,20	P2V-AM511PB	0,40	P2V-BM512PB
	<p>Intermediate manifold, 18 to 26 mm Including seals and fitting screws. For connecting P2V-AM511NB/PB multiple manifolds to P2V-BM511NB/PB multiple manifolds.</p>	0,33	P2V-AM500BE	0,33	P2V-AM500BE
	<p>Connection block G-side, including seal and fitting screws. For side connection.</p>	0,18	P2V-AM512GS	0,21	P2V-BM513GS
	<p>Connection block H-side. For side connection.</p>	0,18	P2V-AM512HS	0,21	P2V-BM513HS
	<p>Connection block G-side, including seal and fitting screws. For top connection.</p>	0,18	P2V-AM512GT	0,21	P2V-BM513GT
	<p>Connection block H-side. For top connection.</p>	0,18	P2V-AM512HT	0,21	P2V-BM513HT
	<p>Connection block G-side, including seal and fitting screws. For bottom connection.</p>	0,18	P2V-AM512GB	0,22	P2V-BM513GB
	<p>Connection block H-side. For bottom connection.</p>	0,18	P2V-AM512HB	0,22	P2V-BM513HB
	<p>End cover G-side, including seal and fitting screws.</p>	0,19	P2V-AM500G0	0,24	P2V-BM500G0
	<p>End cover H-side</p>	0,19	P2V-AM500H0	0,24	P2V-BM500H0
	<p>Plug For sealing supply and exhaust air ducts between multiple manifolds with different primary supply pressures.</p>	0,004	P2V-AK0P	0,01	P2V-BK0P
	<p>Angle mounting set For raising multiple manifolds so that angle connections can be fitted to the underside. The parts are designed so that the entire manifold can be angled to simplify connection of the pipes. The set consists of four mounts, complete with all necessary screws and nuts.</p>	0,14	P2V-AK0M	0,14	P2V-AK0M
	<p>O-ring strip seal For sealing between bases and multiple manifolds. 3.53 mm diameter, Supplied in 5 m lengths.</p>	0,07	9304331543	0,07	9304331543

Side ported manifold

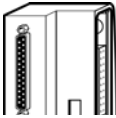
Description	Port size	Order code
	Manifold with two valve positions with terminal Strip (Non collective wiring) Size 01 - 26mm	G1/4 PS551154CP
	Manifold with two single solenoid valve positions with single address board Size 02 - 18mm Size 01 - 26mm	G1/8 G1/4 PS561152JP PS551154JP
	Manifold with two valve positions with double address board Size 02 - 18mm Size 01 - 26mm	G1/8 G1/4 PS561152MP PS551154MP
	Extension Manifold with two valve positions with single address board * Size 02 - 18mm Size 01 - 26mm	G1/8 G1/4 PS561152NP PS551154NP
	Extension Manifold with two valve positions with double address board * Size 02 Size 01	G1/8 G1/4 PS561152PP PS551154PP

* Use only one per manifold assembly to address more 24 solenoid

Side & bottom ported manifold



Description	Port size	Order code
	Manifold with two valve positions with terminal Strip Size 01 - 26mm	G1/4 PS551164CP
	Manifold with two valve positions with single address board Size 02 - 18mm Size 01 - 26mm	G1/8 G1/4 PS561162JP PS551164JP
	Manifold with two valve positions with double address board Size 02 - 18mm Size 01 - 26mm	G1/8 G1/4 PS561162MP PS551164MP
	Extension Manifold with two valve positions with single address board Size 02 - 18mm Size 01 - 26mm	G1/8 G1/4 PS561162NP PS551164NP
	Extension Manifold with two valve positions with double address board Size 02 Size 01	G1/8 G1/4 PS561162PP PS551164PP

Accessories

Description	Order code	
	Blanking plate Size 02 - 18mm Size 01 - 26mm	PS5634P PS5534P
	Manifold to Manifold gasket kit HA & HB Gasket Standard HA & HB Gasket 1 Blocked HA & HB Gasket 1 2 3 Blocked	PS561AP PS561BP PS561CP

 Indicates stocked product.

Collective wiring end plate kits

Description	Port size	Order code
 <p>Left & right ends modules with pressure & exhaust port, auxiliary port , and non collective wiring (only for PS551154CP) Size 02 / 01</p>	G3/8	PS5631011P
 <p>Left & right ends modules with pressure & exhaust port, auxiliary port , and SubD25 connection Size 02 / 01</p>	G3/8	PS5620L21P
<p>Left & right ends modules with pressure & exhaust port, auxiliary port , and 19pin Brad Harrison connection Size 02 / 01</p>	G3/8	PS5620L31P
<p>Left & right ends modules with pressure & exhaust port, auxiliary port , and 12pin M23 connection Size 02 / 01</p>	G3/8	PS5620L41P
<p>Left & right ends modules with pressure & exhaust port, auxiliary port , and 16 point terminal strip Size 02 / 01</p>	G3/8	PS5620L51P
<p>Left & right ends modules with pressure & exhaust port, auxiliary port , and ISYSNET (32 output driver is included) Size 02 / 01</p>	G3/8	PS5620L61P

Accessories

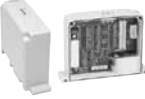
Description	Port size	Order code
 <p>32 output driver module for spare part</p>		PSSV32A
<p>HA & HB 24 Out Cable Size 02 / 01</p>	G3/8	PS5624P
<p>HA & HB 32 Out cable Size 02 / 01</p>	G3/8	PS5632P
<p>25 pin female 25 pin SubD25 cable 3m</p>		P8LMH25M3A

B



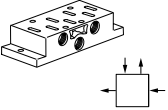

ISO 5599-1 Subbase & Manifolds

VDMA Side Ported Subbases

B

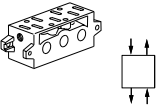
Description	Size	Port size	Weight	Order code
 <p>Subbases VDMA Side port according to VDMA Side port according to VDMA Side port according to VDMA</p>	1 - 43mm	G1/4	0.16	P2N-VS512SD
	2 - 56mm	G3/8	0.28	P2N-WS513SD
	3 - 71mm	G1/2	0.35	P2N-YS514SD

VDMA Bottom Ported Manifold

Description	Size	Port size	Weight	Order code
 <p>VDMA Form C Bottom port according to VDMA Bottom port according to VDMA Bottom port according to VDMA</p>	1 - 43mm	G1/4	0.24	P2N-VM512MB
	2 - 56mm	G3/8	0.36	P2N-WM513MB
	3 - 71mm	G1/2	0.70	P2N-YM514MB
 <p>VDMA Transition plate Size 1 to Size 3 Kit includes: Transition plate only</p>	1 to 3	G1/4		P2N-VM500AK
 <p>VDMA Form D - End plate According to VDMA According to VDMA According to VDMA3 - 71mm</p>	1 - 43mm	G3/8	0.21	P2N-VM513ES
	2 - 56mm	G1/2	0.36	P2N-WM514ES
	0.68			P2N-YM518ES
 <p>VDMA Isolation - Main galley According to VDMA According to VDMA According to VDMA Kit includes: (1) Isolator plug.</p>	1 - 43mm			P2N-VK0P
	2 - 56mm			P2N-WK0P
	3 - 71mm			P2N-YK0P

Accessories

Description	Size	Port size	Weight	Order code
 <p>Blanking plate Kit includes: (1) Blanking plate, (1) Gasket and (4) Mounting bolts</p>	1 - 43mm	G1/4	0.10	P2N-AA5B
	2 - 56mm	G3/8	0.15	P2N-BA5B
	3 - 71mm	G1/2	0.20	P2N-CA5B









Side ported subbases

Description	Size	Port size	Weight	Order code BSP	Order code NPT
 <p>Single subbase 1 3 5 2 4 ports & 12 14</p>	1 - 43mm	G1/4	0.16	PL1-1/4-70	PL1-1/4-80
	1 - 43mm	G3/8	0.16	PL1-3/8-70	
	2 - 56mm	G3/8	0.28	PL2-3/8-70	PL2-3/8-80
	2 - 56mm	G1/2		P2N-HS514SS	
	3 - 71mm	G1/2		PL3-1/2-70	PL3-1/2-80
	3 - 71mm	G3/4		P2N-JS516SD	





Bottom ported subbases

Description	Size	Port size	Weight	Order code BSP	Order code NPT
 <p>Single subbase 1 3 5 2 4 ports & 12 14</p>	1 - 43mm	G1/4	0.37	PD1-1/4-70	PD1-1/4-80
	2 - 56mm	G3/8	0.59	PD2-3/8-70	PD2-3/8-80
	3 - 71mm	G1/2	0.59	PD3-1/2-70	

Size 1 bottom ported manifold

Description	Size	Port size	Weight	Order code
  <p>Manifold with bottom ports low profile</p>	1 - 43mm	G1/4	0.2	P2N-AM512MB
  <p>Connecting block Top or bottom ported connecting block for above manifold "low profile"</p>	1 - 43mm	G3/8	0.15	P2N-AM513GT
  <p>End End piece for above manifold "low profile"</p>	1 - 43mm	no	0.06	P2N-AM500J
  <p>Intermediate supply Top or bottom ported intermediate supply for above manifold "low profile"</p>	1 - 43mm	G3/8	0.14	P2N-AM513BT
 <p>Isolation plugs isolating seal for above manifold "low profile"</p>	1 - 43mm		0.07	P2N-AK0P

Sizes 1 & 2 side ported manifold

Description	Size	Port size	Weight	Order code
  <p>Manifold Manifold with side port</p>	1 - 43mm	G1/4	0.24	P2N-EM512MD
	2 - 56mm	G3/8	0.21	P2N-FM513MD
  <p>End Side ported connecting kit for above manifold with side ports</p>	1 - 43mm	G3/8	0.36	P2N-EM513ES
	2 - 56mm	G1/2	0.29	P2N-FM514ES

Side ported manifold

Description	Size	Port size	Order code
 Manifold with terminal Strip (non collective wiring)	1 - 43mm	G3/8	PS401156CCP
	2 - 56mm	G1/2	PS411158CCP
	3 - 71mm	G3/4	PS421150CCP
Manifold with single address board (single solenoid)	1 - 43mm	G3/8	PS401156JCP
Manifold with double address board	1 - 43mm	G3/8	PS401156MCP



Accessories

Description			Order code
 Blanking plate	1 - 43mm	G3/8	PS4034CP
	2 - 56mm	G1/2	PS4134CP
	3 - 71mm	G3/4	PS4234CP
Insulation plug	1 - 43mm	G3/8	PS4032CP
	2 - 56mm	G1/2	PS4132CP
	3 - 71mm	G3/4	PS4232CP
Manifold to Manifold gasket kit	1 - 43mm	G3/8	PS4013P

Coils for plug in valve

Description		Order code
	12 V DC	5599-2 coil PS404145P
	24 V DC	5599-2 coil PS4041B9P
	24 V AC	5599-2 coil PS404142P
	120 V AC	5599-2 coil PS404123P
	240 V AC	5599-2 coil PS404157P

Collective wiring end plate kits

	Description	Port size	Order code
	Left & right ends modules with pressure & exhaust port, auxiliary port , and non collective wiring		
	Size 1	G1/2	PS4031011CP
	Size 2	G3/4	PS4131011CP
	Size 3	G3/4	PS4231011CP
	Left & right ends modules with pressure & exhaust port, auxiliary port , and SubD25 connection		
	Size 1	G1/2	PS4020L21CP
	Left & right ends modules with pressure & exhaust port, auxiliary port , and 19pin Brad Harrison connection		
	Size 1	G1/2	PS4020L31CP
	Left & right ends modules with pressure & exhaust port, auxiliary port , and 12pin M23 connection		
Size 1	G1/2	PS4020L41CP	
	Left & right ends modules with pressure & exhaust port, auxiliary port , and ISYSNET		
Size 1	G3/8	PS4020L61CP	

Accessories

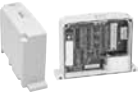
	Description	Order code
	32 output driver module for spare part	PSSV32A
	HA & HB 24 Out Cable	PS4024P
	25 pin female 25 pin SubD25 cable 3m	P8LMH25M3A
	H1 H2 H3 Pilot Gasket	PS4007P
	Valve to base gasket	PS4005CP

Accessories - Sandwich Regulator

Features

- Remote air pilot operated for hard-to-reach pressure control.
- Unregulated pilot pressure to valve for consistent valve shifting regardless of pressure adjustment.

Gauge adaptor kit

Included with all HB Regulators. Both kits are required on all HA & HB Regulators when the Regulator is on the last station on the right (14) end.



Description	Order code
Gauge kit	PS5651160P

HB & HA Common Port Regulation

Provides adjustable regulated air pressure to the valves #1 port which gives the same pressure to both the #2 and #4 port of the manifold or subbase. The regulator is always on the 14 end of the valve.

Common port regulator with 4-way, 2-position single solenoid valve

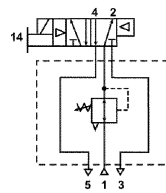

Common port regulator with 4-way, 3-position APB valve

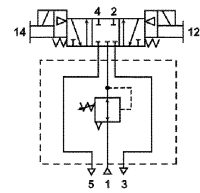

HA - 26mm (Common Port Regulator shown)



8 bar	Order code	
	Plug-in	Non Plug-in
Size 18mm	PS5638133P	PS5637133P
Size 26mm	PS5538133P	PS5537133P

HB & HA Independent Port Regulation

Dual Port Regulator

Provides regulated pressure to both ports. Pressure regulation can occur out of the #2 or #4 port of the valve. In this case #2 and #4 have to be cross wired.

3 position CP have to be used as a COE
3 position COE have to be used as a CP

Independent dual port regulator with 4-way, 2-position double solenoid valve

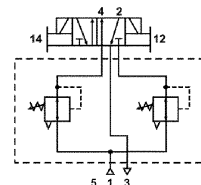

Order chart - Sandwich Regulator (please contact Parker Sales Office)

PS5637	1	6	6	P																																						
Series	Regulator function	#4 Port regulator / Gauge*	#2 Port regulator / Gauge*																																							
<table border="1" style="width: 100%; border-collapse: collapse;"> <tr><td colspan="3" style="text-align: center;">HB</td></tr> <tr><td>15407-1 18mm</td><td style="text-align: center;">PS5637</td><td></td></tr> <tr><td>15407-2 18mm</td><td style="text-align: center;">PS5638</td><td></td></tr> <tr><td colspan="3" style="text-align: center;">HA</td></tr> <tr><td>15407-1 26mm</td><td style="text-align: center;">PS5537</td><td></td></tr> <tr><td>15407-2 26mm</td><td style="text-align: center;">PS5538</td><td></td></tr> </table>	HB			15407-1 18mm	PS5637		15407-2 18mm	PS5638		HA			15407-1 26mm	PS5537		15407-2 26mm	PS5538		<table border="1" style="width: 100%; border-collapse: collapse;"> <tr><td style="text-align: center;">1</td><td>Common pressure regulator</td></tr> <tr><td style="text-align: center;">2</td><td>Independent pressure regulator</td></tr> </table>	1	Common pressure regulator	2	Independent pressure regulator	<table border="1" style="width: 100%; border-collapse: collapse;"> <tr><td style="text-align: center;">2</td><td>2-60 PSIG w/o Gauge</td></tr> <tr><td style="text-align: center;">3</td><td>5-125 PSIG w/o Gauge</td></tr> <tr><td style="text-align: center;">5</td><td>2-60 PSIG w/Gauge</td></tr> <tr><td style="text-align: center;">6</td><td>5-125 PSIG w/Gauge</td></tr> </table>	2	2-60 PSIG w/o Gauge	3	5-125 PSIG w/o Gauge	5	2-60 PSIG w/Gauge	6	5-125 PSIG w/Gauge	<table border="1" style="width: 100%; border-collapse: collapse;"> <tr><td style="text-align: center;">2</td><td>2-60 PSIG w/o Gauge</td></tr> <tr><td style="text-align: center;">3</td><td>5-125 PSIG w/o Gauge</td></tr> <tr><td style="text-align: center;">5</td><td>2-60 PSIG w/Gauge</td></tr> <tr><td style="text-align: center;">6</td><td>5-125 PSIG w/Gauge</td></tr> </table>	2	2-60 PSIG w/o Gauge	3	5-125 PSIG w/o Gauge	5	2-60 PSIG w/Gauge	6	5-125 PSIG w/Gauge	
HB																																										
15407-1 18mm	PS5637																																									
15407-2 18mm	PS5638																																									
HA																																										
15407-1 26mm	PS5537																																									
15407-2 26mm	PS5538																																									
1	Common pressure regulator																																									
2	Independent pressure regulator																																									
2	2-60 PSIG w/o Gauge																																									
3	5-125 PSIG w/o Gauge																																									
5	2-60 PSIG w/Gauge																																									
6	5-125 PSIG w/Gauge																																									
2	2-60 PSIG w/o Gauge																																									
3	5-125 PSIG w/o Gauge																																									
5	2-60 PSIG w/Gauge																																									
6	5-125 PSIG w/Gauge																																									
		<small>* For common pressure regulator option. Regulator gauge callout must be the same number for both Port #4 and port #2. (Example: 166)</small>	<small>* For common pressure regulator option. Regulator gauge callout must be the same number for both Port #4 and port #2. (Example: 166)</small>																																							

B

How to Configure Sandwich Regulator / Valve Combinations

Ordering Components

- Manifold or Subbase Kit required.
- Sandwich Regulator Kit configured for Internal Pilot as standard.
- Order valve as External Pilot.

Internal Pilot Configuration -

Pressure in Base Port 1 feeds regulator configured for Internal Pilot which feeds valve configured for External Pilot.

Flow control - ISO 15407 - Sandwich flow controls features

- Both adjustment screws are located on the 12 end of the unit.
- Sandwich Flow Control mounts with its own studs, which means the valve uses standard bolts for mounting.
- Sandwich Flow Control is not to be used as a shut off device and is not bubble tight when needles are fully turned down.



Size	Order code	
	Plug-in	Non Plug-in
	15407-2	15407-1
Size 18mm	PS5635P	PS5642P
Size 26mm	PS5535P	PS5542P

Regulators - Size 1 / 2 / 3 - ISO 5599

Accessories - Sandwich Regulator

Features

- Remote air pilot operated for hard-to-reach pressure control.
- Unregulated pilot pressure to valve for consistent valve shifting regardless of pressure adjustment.

Gauge adaptor kit

Included with all HB Regulators. Both kits are required on all HA & HB Regulators when the Regulator is on the last station on the right (14) end.



Description	Order code
Gauge kit	PS5651160P

ISYS ISO 1 / 2 / 3 Common Port Regulation

Provides adjustable regulated air pressure to the valves #1 port which gives the same regulated pressure to both the #2 and #4 port of the manifold or subbase. The regulator is always on the 14 end of the valve.

Common port regulator with 4-way, 2-position single solenoid valve

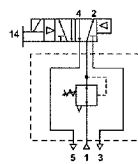

Common port regulator with 4-way, 3-position APB valve

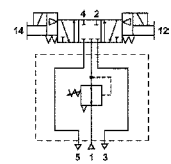

Order code

Plug-in

Non Plug-in

Size 1	8 bar	PS4038133CP	PS4037133CP
--------	-------	--------------------	--------------------

ISYS ISO 1 / 2 / 3 Independent Port Regulation

Dual Port Regulator or Single Port Regulator

Provides regulated pressure to both ports. Pressure regulation can occur out of the #2 or #4 port of the valve. Full line pressure would be provided with a pass plate.



When using an independent Pressure Sandwich Regulator, the cylinder outlet ports are reversed. The 12 end energizes the #2 port. The 3-Position CE and PC functions are also reversed. (See schematics on right).

Independent dual port regulator with 4-way, 2-position double solenoid valve

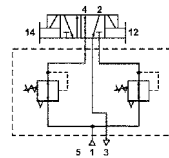

Independent port regulator with 4-way, 3-position all ports blocked valve

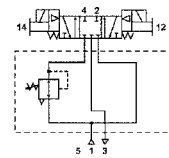

Independent port regulator with 4-way, 3-position inlet to cylinder function

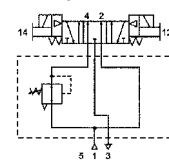

Independent port regulator with 4-way, 3-position cylinder to exhaust function

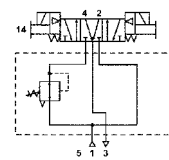

ISYS ISO 1 / 2 / 3 Selector Regulation

Supplies two different pressures to the valves #1 and #3 flow paths. Shifting the valve "selects" one or the other of these two pressures to flow out port #2. A Selector Regulator can: 1) Provide regulated pressure to one flow path and full line pressure to the other by use of the Line Pressure By-Pass Plate.

Selector regulator with 4-way, 2-position single solenoid valve

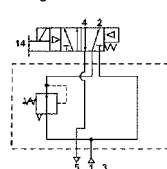

Order chart - Sandwich Regulator (please contact Parker Sales Office)

PS4037	1	6	6	C	P
Series	Regulator function	#4 Port regulator / Gauge*	#2 Port regulator / Gauge*		
ISYS ISO Size 1 5599-1 PS4037 5599-2 PS4038	1 Common pressure regulator 2 Independent pressure regulator 3 Selector Regulator	0 Line By-Pass Plate** 1 1-30 PSIG w/o Gauge 2 2-60 PSIG w/o Gauge 3 5-125 PSIG w/o Gauge 4 1-30 PSIG w/Gauge 5 2-60 PSIG w/Gauge 6 5-125 PSIG w/Gauge C Air Pilot w/60 PSIG Gauge D Air Pilot w/60 PSIG Gauge	0 Line By-Pass Plate** 1 1-30 PSIG w/o Gauge 2 2-60 PSIG w/o Gauge 3 5-125 PSIG w/o Gauge 4 1-30 PSIG w/Gauge 5 2-60 PSIG w/Gauge 6 5-125 PSIG w/Gauge C Air Pilot w/60 PSIG Gauge D Air Pilot w/60 PSIG Gauge		
ISYS ISO Size 2 5599-1 PS4137 5599-2 PS4138					
ISYS ISO Size 3 5599-1 PS4237 5599-2 PS4238					

* For common pressure regulator option. Regulator gauge callout must be the same number for both Port #4 and port #2. (Example: 166)

** Pressure Line By-Pass Option can only be used with independent and Selector Regulators (Option 2 & 3 in Sandwich Block Function).

* For common pressure regulator option. Regulator gauge callout must be the same number for both Port #4 and port #2. (Example: 166)

** Pressure Line By-Pass Option can only be used with independent and Selector Regulators (Option 2 & 3 in Sandwich Block Function).

How to Configure Sandwich Regulator / Valve Combinations

Ordering Components

- Manifold or Subbase Kit required.
- Sandwich Regulator Kit configured for Internal Pilot as standard.
- Order valve as External Pilot.

Internal Pilot Configuration -

Pressure in Base Port 1 feeds regulator configured for Internal Pilot which feeds valve configured for External Pilot.

External Pilot Configuration - H1, H2, H3

An External Pilot pressure in Port 12 or 14 of the base feeds thru the Sandwich Regulator 12 or 14 galley directly to the 12/14 pilot of the valve.

This configuration takes an External Pilot from the 12 port of the base and passes it thru the regulator to feed the 12 galley of the valve.

Flow Control - Size 1 / 2 / 3 - ISO 5599 - Sandwich flow controls features

- Both adjustment screws are located on the 12 end of the unit.
- Sandwich Flow Control mounts with its own studs, which means the valve uses standard bolts for mounting.

Size	Order code	
	Plug-in	Non Plug-in
	5599-2	5599-1
Size 1	PS4035CP	PS4042CP
Size 2	PS4135CP	PS4142CP
Size 3	PS4235CP	PS4242CP

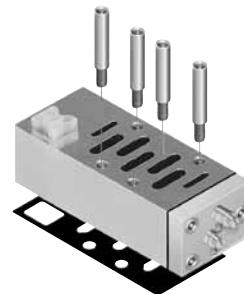

**Plug-In
5599-2
Size 2 Shown**

Isomax - Dimensions (mm)

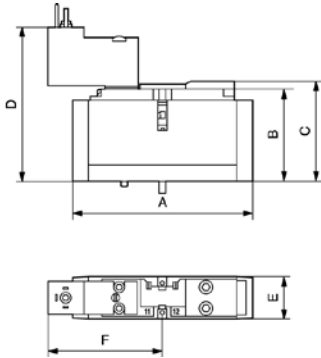

Pneumatically actuated

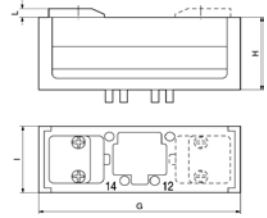

With P2F solenoids

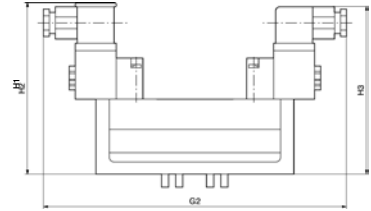

	A	B	C	D	E	F
Isomax 02	80	41	44,5	67,8	18	51,2
Isomax 01	100	42	45,5	68,8	26	51,2

	G	G1	G2	G3	H	H1	I	L
Size 1	120	164	202,5	160	47	119	42	5
Size 2	140	179,5	218	175,5	58,5	130	54	5
Size 3	170	198	235,5	194	71	142,5	68	5

Single subbases side ported

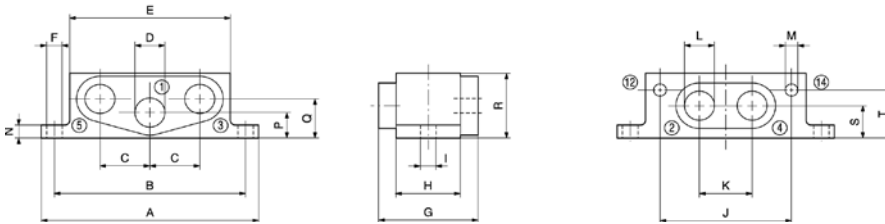

	Size	A	B	C	D	E	F	G	H	I	J	K	L	M	N	P	Q	R	S	T
PL02-01-70	02	80	70	16	G1/8	52	8	27	19	5,5	40	17	G1/8	M5	8	8	8	22	13	6
P2V-BS512SS	01	92	80	21,2	G1/8	68	6,5	42	27	5,5	55	22	G1/8	M5	6	11	17	28	14	21

Side ported manifolds for 2 valve positions

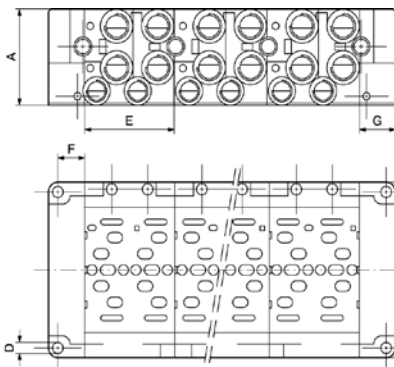

	Size	A	B	C	D	E	F	G	H
PJLP02-201-70	02	38,5	80	12	Ø4,2	38	14	18	72
PJLP01-201-70	01	55	100	24	Ø5,5	54	17	22	90
PJLP01-202-70									

A

Bottom ported manifolds for 2 valve positions

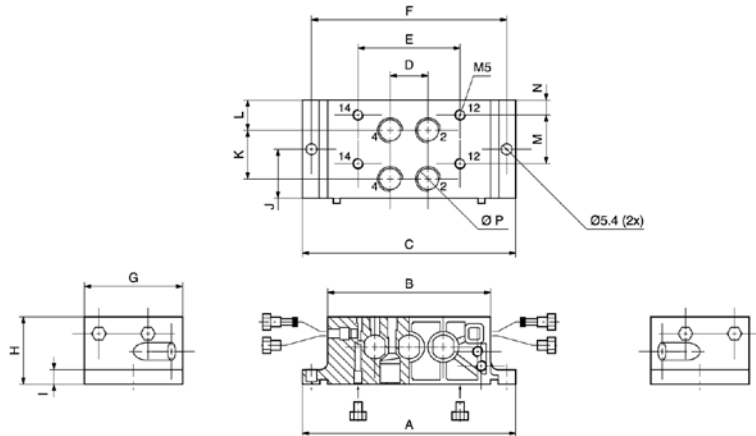

	Size	A	B	C	D	E	F	G	H	I	J	K	L	M	N	P
P2V-AM511PB	02	102	74	74,6	16	43	92	38	26	7	19	19	11	19	5	G1/8
P2V-BM512PB	01	118	90	90,6	21	56,5	108	54	37	8	27	27	16,5	27	8	G1/4

G and H side end plate bottom ported for above bottom ported manifold

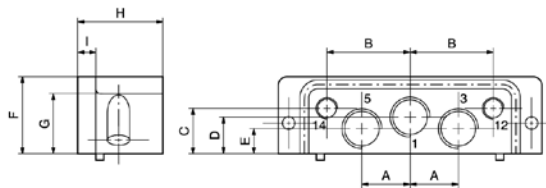

	Size	Port size 1,2,3	Port size 12, 14	A	B	C	D	E	F	G	H	I
P2V-AM512GB and P2V-AM512HB	02	G1/4	G1/8	17	29	21	18,5	9,5	35,5	28	33	7
P2V-BM513GB and P2V-BM513HB	01	G3/8	G1/8	21,5	37	20	16	11	34,5	28	38	8

Transfer plate size 01 to size 02 for above bottom ported manifold

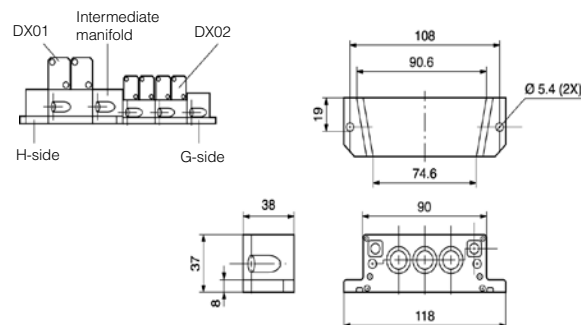

Single subbase with side ports according to VDMA - Dimensions

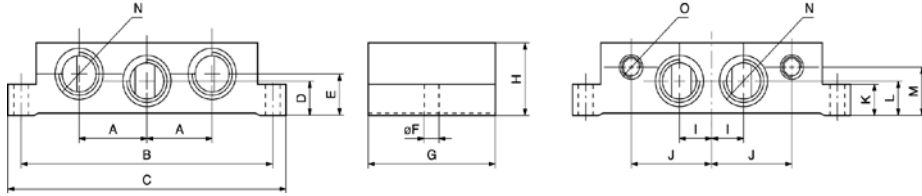

Order code	Size ISO	Port Size	A	B	C	D	E	F	G	H	I	J	K	L	M	N	O
P2N-VS512SD	1	G1/4	21,5	98	110	11	20	5,5	48	32	12	29	10	11	23	G1/4	G1/8
P2N-WS513S	2	G3/8	28	112	124	14	26	6,6	56	40	15	37	13	14	30	G3/8	G1/8
P2N-YS514SD	3	G1/2	34	136	149	17	17	6,6	71	32	16	45	18	17	22	G1/2	G1/8

Single subbase with side ports

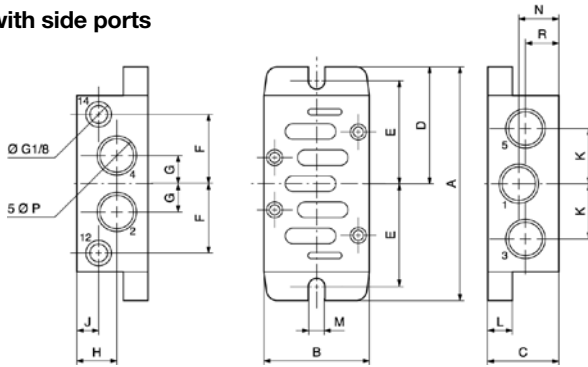

Order code	ISO Size	ØP	A	B	C	D	E	F	G	H	J	K	L	M	N	R
PL1-1/4-70	1	G1/4	110	46	29	55	49	30	11	17,75	17,75	22	6	5,5	17,75	17,75
PL2-3/8-70	2	G3/8	124	56	37	62	55	37	14,5	22,5	14	28	6	5,5	22,5	14,5
P2N-JS516SD	3	G3/4	149	71	60	74,5	68	45	21	33	10	40	18	6,6	37,5	22,5

Single subbase with bottom ports

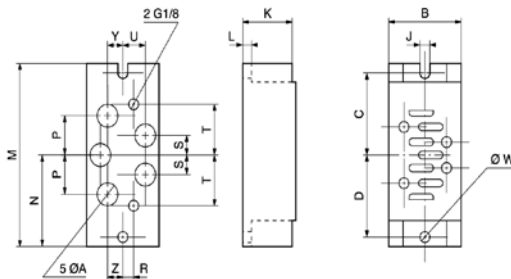

Order code	A	B	C	D	J	K	L	M	N	P	R	S	T	U	W	Y	Z
PD1-1/4-70	G1/4	46	49	49	5,5	29	6	110	55	22	10	11	30	10	5,5	10	10
PD2-3/8-70	G3/8	56	55	55	5,5	37	6	124	62	29	10	14,5	37	12,5	5,5	12,5	12,5
PD3-1/2-70	G1/2	77	68	68	6,6	32	18	149	74,5	34	10	17	45	17	6,5	17	17

Manifold and end plates according to VDMA (P2N-VM / WM / YM) - Dimensions

A

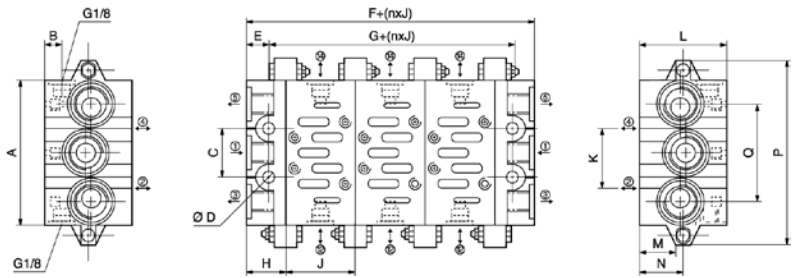

ISO Size	Port 1, 3, 5	Port 2, 4	A	B	C	D	E	F	G	H	J	K	L	M	N	O	P
1	G3/8	G1/4	85	8,5	28	7	11	44	22	22	43	26	46	21	24	56	110
2	G1/2	G3/8	100	9	35	9	13	52	26	26	56	30	47	22	24	68	135
3	G1	G1/2	140	10	52	12	15	60	30	30	71	38	56	31	34	104	190

Manifold and end plates with bottom ports "low profile" (P2N-AM..)

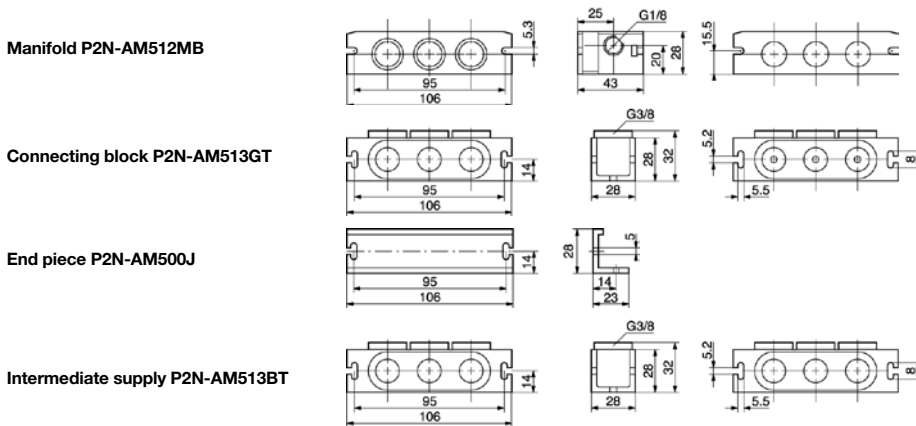

Manifold and end plates with side ports (P2N-EM / FM..)

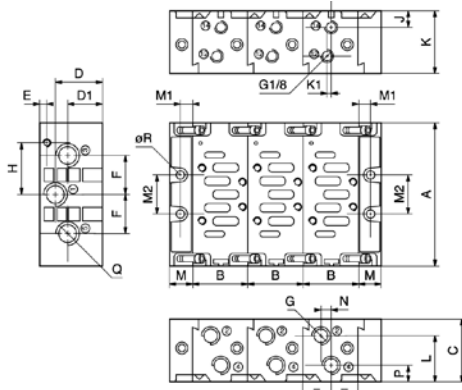

Order code	A	B	C	D	D1	E	F	G	H	J	K	K1	L	M	M1	M2	N	P	Q	R
P2N-EM ...	110	43	48	35,5	26,5	5,5	28	G1/4	36	15,5	35	3	32	20	11	28	12	12,5	G3/8	6
P2N-FM ...	129	56	60	44,5	35,5	6	34,5	G3/8	45	16	41,5	3	41	24	13	35	12,5	16	G1/2	8

H1 5599-2 / 5599-1 Manifold

A

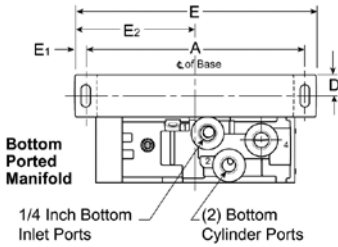
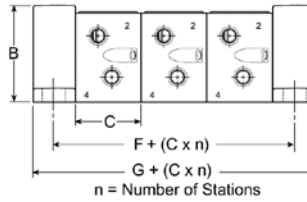
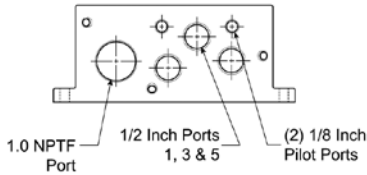

Manifold with Optional Collective Wiring System

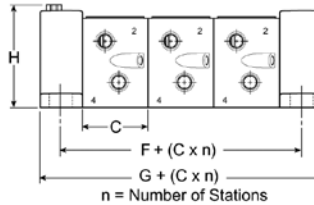

	A	B	C	D	E	E ₁	E ₂	F	G	H
H1	165	73	49	15.9	182	.84	91	31.8	63.5	76

H2 / H3 5599-2 / 5599-1 Manifold

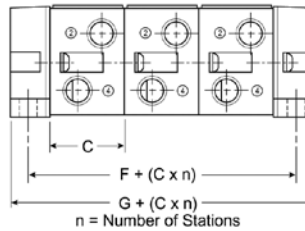
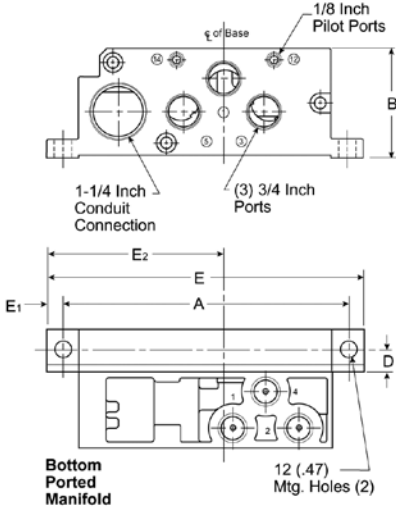

Manifold with Optional Collective Wiring System

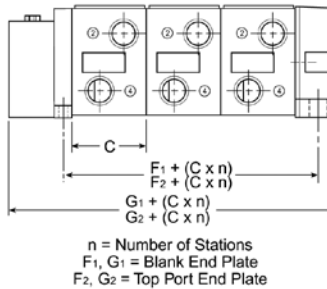

	A	B	C	D	E	E ₁	E ₂	F	F ₁	F ₂	G	G ₁ *	G ₂ *
H2	215	85	56	15	239	12	134	30	27	33	60	87	99

	A	B	C	D	E	E ₁	E ₂	F	F ₁	F ₂	G	G ₁ *	G ₂ *
H3	265	105	71	17	295	15	159	33	29	41	63	90	114

Interconnect Circuit Boards

A

Maximum Solenoids Energized Simultaneously

HA HB	Voltage code	25-pin D-Sub	19-pin round	Single 12-pin M23	Isysnet	
24 V DC	B9 / G9	24	16	8	32	
120 V AC*	23	24	16	8	32	
H1 H2 H3	Voltage code	25-pin D-Sub	19-pin round	Single 12-pin M23	Isysnet	SAM 3.0
12 V DC	45	13	13	8	N/A	N/A
24 V AC*	42	24	16	8	N/A	N/A
24 V DC	B9	20	16	8	21	4
120 V AC*	23	24	16	8	N/A	N/A

* Not CSA certified for 25-pin, D-Sub option.

19-Pin Round Brad Harrison

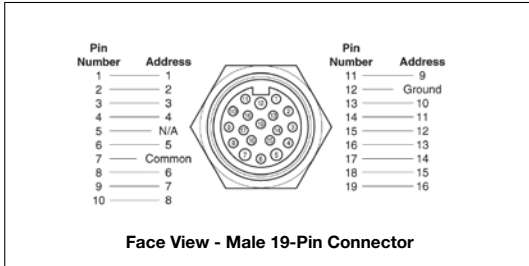

25-Pin, D-Sub Connector (Male)

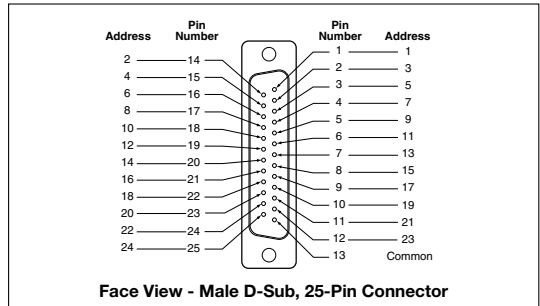

25-Pin, D-Sub Cable (Female)

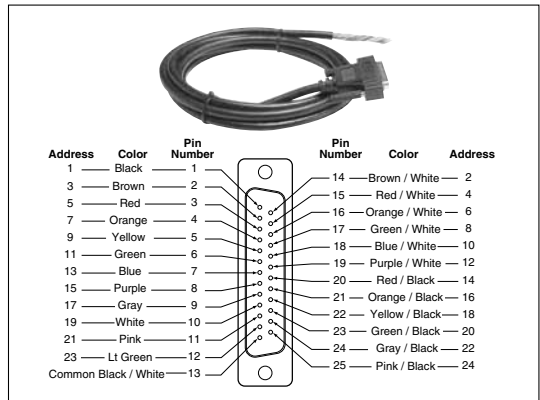

19-Pin Round Cable Specifications

Common Pin "7" is rated for 8 amps. Cable common wire must be greater than total amperage of solenoids on Add-A-Fold assembly.

Example:- 8 station manifold, 16 solenoids, 120VAC - 16 x .039 amps = .63 total amp rating. NEMA 4 rated with properly assembled NEMA 4 rated cable.

Brad Harrison #333030P80M050 16.40 ft. (Female to Male Cable)

Brad Harrison #333030P80M0100 32.80 ft. (Female to Male Cable)

25-Pin, D-Sub Cable Specifications

Common Pin "13" is rated for 3 amps. Common wire rating must be greater than total amperage of all solenoids on a Add-A-Fold assembly.

IP65 rated with properly assembled IP65 rated cable.

M23, 12-Pin Round Connector (Male)

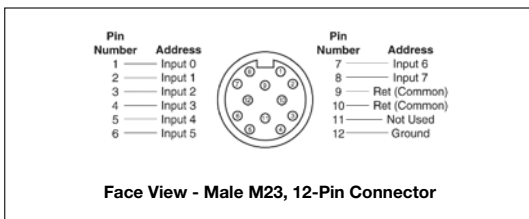

M23, 12-Pin Round Connector (Female)

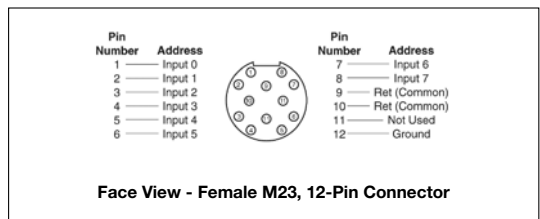

Pneumatic variants using Isysnet Industrial communication system for Centralised applications

Isysnet device with electric modules only



Isysnet with Isys Micro extended device



Isysnet with Isys Micro Valves island



Isysnet with Isys ISO valves island

Isys ISO 15407-2 – HA & HB
Isys ISO 5599-2 – H1

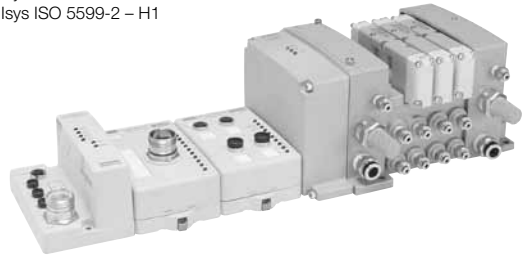

Pneumatic variants using Moduflex Fieldbus modules for Decentralised applications

Moduflex Bus with Moduflex Valve System



Moduflex Bus with Isys Micro Valves island



Moduflex Bus With Isys ISO 15407-2 or 5599-2 valves island

Isys ISO 15407-2 – HA & HB
Isys ISO 5599-2 – H1

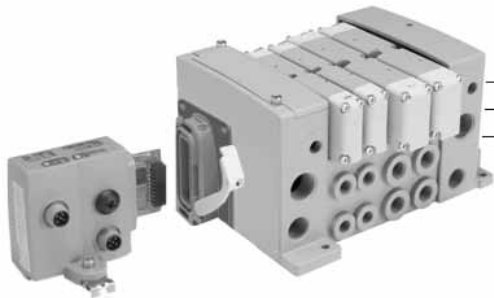

Isysnet Device constitution overview for a Centralised application

For main device

For both main and extended devices



For extended device

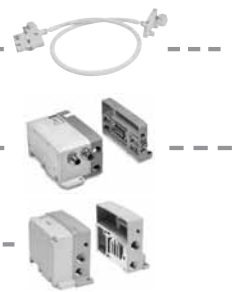

Communication modules :

- Fieldbus or Industrial Ethernet protocol
- Network connection
- Separated 24VDC for logic and user power supply
- Configuration with coding wells and bus status display by LED

Bus extender cable :

- Cable linking extended device through the Sub-network
- Sub-network connection from Isysnet module or Isys Micro Valve driver
- Transferring both sub-network communication and 5VDC for bus power supply

I/O modules :

- Choice of Digital or Analogic I/O modules offering multiple industrial connection types
- Connection to the Sub-network and the separated 24VDC for both logic and user through the socket
- I/O and sub-network status display by LEDs

Power extender module :

- Additional separated 24VDC power supply for logic and user allowing multiple permanent or safety power supply recommendations
- Both Logic and User electrical power supply display by separated LEDs

Isysnet end section :

- Specific socket or valve driver without extender bus connector for Isysnet end section

Isysnet prologation section :

- Specific socket with sub-network extender cable and extended device head plate
- Valve driver including extender bus connector for sub-network continuity

Moduflex constitution overview for a Decentralised application



Communication module :

- Fieldbus protocols
- Network connection
- Separated power supply for communication and solenoid valves
- Addressing and speed communication configuration by coding wells
- Bus status display by LED

Bus module adaptor :

Using the appropriate adaptor, the Moduflex Bus module can be assembled to :

- Moduflex Valve System
- Isys Micro
- Isys ISO 15407-2 – HA & HB
- Isys ISO 5599-2 – H1

Isysnet Industrial Communication modules



A choice of different protocols to connect the Isysnet device to the requested industrial network :

- DeviceNet
- Profibus DP
- ControlNet
- Ethernet I/P

Digital and Analogue Isysnet I/O modules :



Application always needs a wide sensor quantity, diversity and additional electric actuators as well, with an appropriate electrical connection.

With a modularity from 2 to 16 channels, the wide Isysnet range of digital or analogue inputs and outputs modules offers a choice of industrial connection :

- M8 - 3 PINs
- M12 - 5 PINs
- M23 - 12 PINs

Isysnet extension power supply module :



The auxiliary power from the communication module supports up to 10 I/O modules. Also, for application needing a huge I/O modules quantity, this 24VDC extension power module extends the backplane bus power to support up to 10 more I/O modules.

Also, when safety recommendations require multiple permanent and safety power supplies, this 24VDC extension power module avoids to get a separated power supply section in the Isysnet device.

Isysnet and Isys Micro bus extender cable



An Isysnet device can be split into the Isysnet section or, from an Isys Micro valve manifold to an extended Isysnet section. Both cables avoid the backplane Bus power and communication.

The Isysnet device has to be closed with a 32 output driver (internally ending the backplane bus) or using the Isysnet terminating base module

Isysnet 32 Outputs driver for valve islands in centralised applications

Isysnet 32 Outputs driver for Isys Micro Valve Islands



- Isys Micro valve nominal flow up to 280 NI/mn
- 32 outputs per module to handle up to 32 solenoids per valve island
- Up to 4 valve islands linked through the internal sub-network for a total of 128 solenoids per device
- With or without additional user power supply
- With or without bus extender

Isysnet 32 Outputs driver for Isys ISO Valve Islands



- ISO 15407-2 Size 02 (HB) 18 mm 380 NI/mn
- ISO 15407-2 Size 01 (HA) 26 mm 590 NI/mn
- ISO 5599-2 Size 1 (H1) 42 mm 1030 NI/mn
- 32 outputs per module to handle up to 32 solenoids per valve island.

Moduflex fieldbus modules for valve islands in decentralised applications

Moduflex fieldbus adaptor for Isys Micro and Isys ISO valve islands





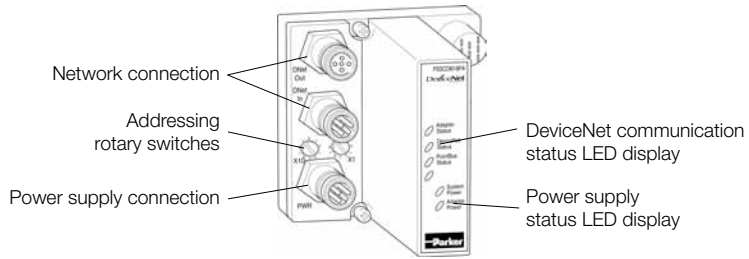

- Compatible with all Moduflex fieldbus protocol modules handling up to 16 solenoids:
 - DeviceNet
 - CANopen
 - Profibus DP
 - InterBus-S
 - AS-i standard and extended a-b coding versions.

DeviceNet communication module

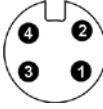

DeviceNet Adapters

DeviceNet module order code	PSSCDM12A	PSSCDM18PA
Adapters connection		
Power supply connection	7/8" - 4 PINs - Male :  <ul style="list-style-type: none"> - PIN 1 : User power + - PIN 2 : Adapter power + - PIN 3 : Adapter power - - PIN 4 : User power - 	
Bus IN connection	M12 - 5 PINs - Male - A coding	M18 - 5 PINs - Male :
	  <ul style="list-style-type: none"> - PIN 1 : Drain - PIN 2 : DeviceNet V+ - PIN 3 : DeviceNet V- - PIN 4 : CAN High - PIN 5 : CAN Low 	
Bus OUT connection	M12 - 5 PINs - Female - A coding	M18 - 5 PINs - Female :
	  <ul style="list-style-type: none"> - PIN 1 : Drain - PIN 2 : V+ - PIN 3 : V- - PIN 4 : CAN High - PIN 5 : CAN Low 	
LED display	1 - Adapter status : green/red 2 - DeviceNet status : green/red 3 - Status : green/red 4 - System power (5V power) : green 5 - Adapter power (24V from field supply) : green	

DeviceNet communication module connection accessories





P8CS1205BA

Description	Connector type	W (g)	Order code
Power supply connector	7/8" - 4 PINs	40	P8CS7804AA
Bus IN connector	M12 female - A coding	25	P8CS1205AA
Bus OUT connector	M12 male - A coding	25	P8CS1205BA
Line terminaison	M12 male - A coding	25	P8BPA00MA

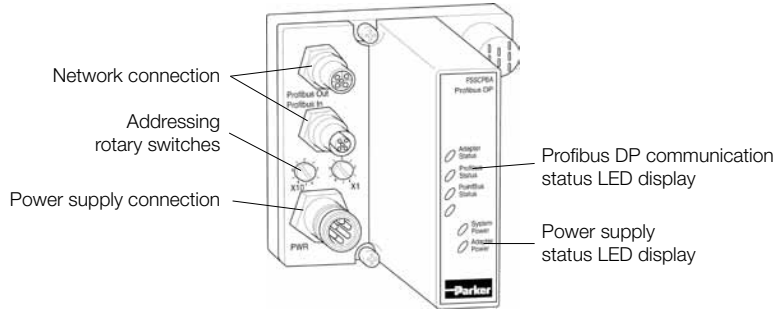
Profibus DP communication module

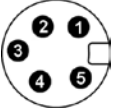

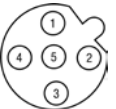
Profibus DP Adapters	
Profibus DP module order code	PSSCPBA
Profibus DP adapters connection	
Power supply connection	<p>7/8" - 5 PINs - Male :</p>  <ul style="list-style-type: none"> - PIN 1 : User power - - PIN 2 : Adapter power - - PIN 3 : Protective GND - PIN 4 : Adapter power + - PIN 5 : User power +
BUS IN connection	<p>M12 - 5 PINs - Male - B coding</p>  <ul style="list-style-type: none"> - PIN 1 : + 5 VDC Bus - PIN 2 : A - Line - PIN 3 : GND Bus - PIN 4 : B - Line - PIN 5 : Shield
BUS OUT connection	<p>M12 - 5 PINs - Female - B coding</p>  <ul style="list-style-type: none"> - PIN 1 : + 5 VDC Bus - PIN 2 : A - Line - PIN 3 : GND Bus - PIN 4 : B - Line - PIN 5 : Shield
LED display	<p>1 - Adapter status : green/red 2 - Profibus DP status : green/red 3 - Bus status : green/red 4 - System power (5V power) : green 5 - Adapter power (24V from field supply) : green</p>

Profibus DP communication module connection accessories



P8CS1205BB

Description	Connector type	W (g)	Order code
Power supply connector	7/8" - 5 PINs	40	P8CS7805AA
Bus IN connector	M12 female - B coding	25	P8CS1205AB
Bus OUT connector	M12 male - B coding	25	P8CS1205BB
Line terminaison	M12 male - B coding	25	P8BPA00MB

ControlNet communication module



ControlNet™

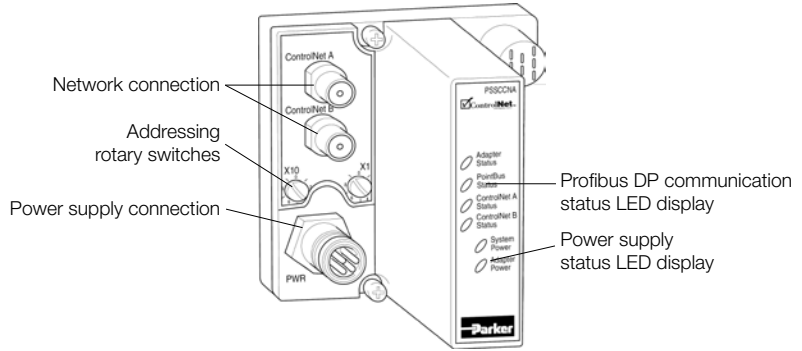

ControlNet Adapters	
ControlNet module order code	PSSCCNA
ControlNet adapters connection	
Power supply connection	7/8" - 4 PINs - Male :  - PIN 1 : User power + - PIN 2 : Adapter power + - PIN 3 : Adapter power - - PIN 4 : User power -
ControlNet IN connection	TNC style connector
ControlNet OUT connection	TNC style connector
LED display	1 - Adapter status : green/red 2 - Bus status : green/red 3 - ControlNet A status : green/red 4 - ControlNet B status : green/red 5 - System power (Bus 5V power) : green 6 - Adapter power (24V from field supply) : green

ControlNet communication module connection accessories





P8CS7804AA

Description	Connector type	W (g)	Order code
Power supply connector	7/8" - 4 PINs	40	P8CS7804AA

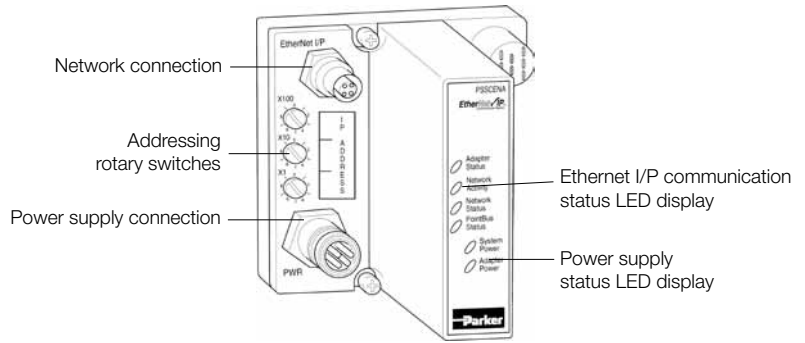
Ethernet I/P communication module



Ethernet I/P Adapters	
Ethernet I/P module order code	PSSCENA
Ethernet I/P adapters connection	
Power supply connection	<p>7/8" - 4 PINs - Male :</p>  <ul style="list-style-type: none"> - PIN 1 : User power + - PIN 2 : Adapter power + - PIN 3 : Adapter power - - PIN 4 : User power -
Ethernet I/P connection	<p>M12 - 4 PINs - Female - D coding :</p>  <ul style="list-style-type: none"> - PIN 1 : Tx + - PIN 2 : Rx + - PIN 3 : Tx - - PIN 4 : Rx -
LED display	<ul style="list-style-type: none"> 1 - Adapter status : green/red 2 - Network activity : green 3 - Network status : green/red 4 - Bus status : green/red 5 - System power (Bus 5V power) : green 6 - Adapter power (24V from field supply) : green

Ethernet I/P communication module connection accessories





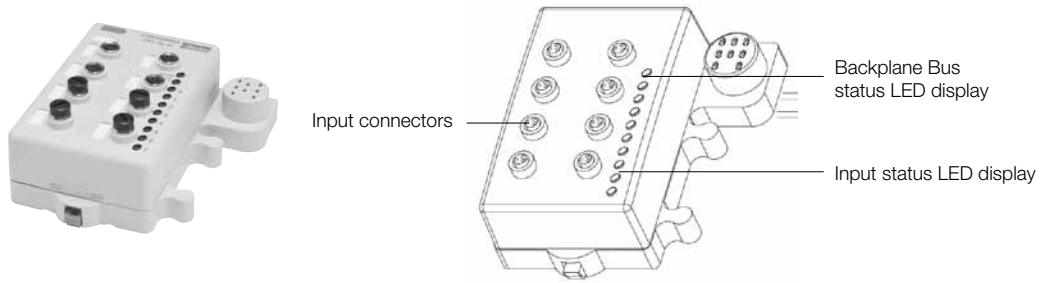

P8CS7804AA

Description	Connector type	W (g)	Order code
Power supply connector	7/8" - 4 PINs	40	P8CS7804AA

Isysnet Digital Input modules

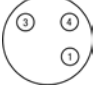



Isysnet Digital DC Input modules				
Input module order code	PSSN8M8A	PSSP8M8A	PSSN8M12A	PSSP8M12A
				
Nb of Inputs	8	8	8	8
Nb of Input connectors	8 x M8	8 x M8	4 x M12	4 x M12
Input density / connector	1	1	2	2
Sensor polarity	PNP	NPN	PNP	NPN
Input module connection				
Input connector	M8 - 3 PINs - Female  - PIN 1 : + 24 VDC - PIN 3 : Common - PIN 4 : Input		M12 - 5 PINs - Female  - PIN 1 : + 24 VDC - PIN 2 : Odd input (1, 3, 5, 7) - PIN 3 : Common - PIN 4 : Even input (0, 2, 4, 6) - PIN 5 : n/a	
Input status LED display (Logic side)	8 x Yellow			
Backplane Bus status LED display (Logic side)	Network status : 1 x green / red Module status : 1 x green / red			

Isysnet Backplane Bus accessories







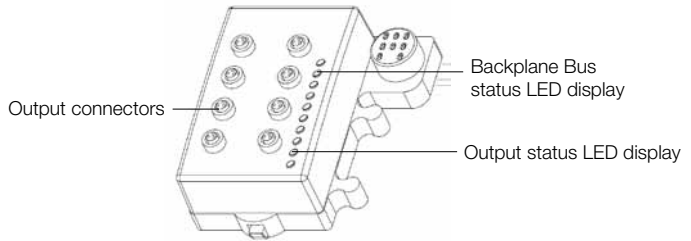

Description	Cable length	W (g)	Order code
	1 meter	380	PSSEXT1
	3 meter	760	PSSEXT3
	Terminaison module	200	PSSTERM

Connectors for inputs

Description	Connector type	W (g)	Order code
	M8 male	25	P8CS0803J
	M12 male - A coding	25	P8CS1204J
 P8CSY1212A	M12 male - 2 x M12 female	25	P8CSY1212A

Isysnet Digital Output modules



Isysnet Digital DC Output modules				
Output module order code	PSST8M8A	PSST8M12A	PSST8M23A	PSSTR4M12A
				
Nb of Outputs	8	8	8	4
Nb of Output connectors	8 x M8	4 x M12	1 x M23	4 x M12
Output density / connector	1	2	8	1
Output module connection				
Output connector	M8 - 3 PINS Female  - PIN 1 : +24 VDC - PIN 3 : Common - PIN 4 : Outputs (0 to 7)	M12 - 5 PINS Female  - PIN 1 : +24 VDC - PIN 2 : Odd input (1, 3, 5, 7) - PIN 3 : Common - PIN 4 : Even input (0, 2, 4, 6) - PIN 5 : n/a	M23 - 12 PINS Female  - PIN 1 : Output 0 - PIN 2 : Output 1 - PIN 3 : Output 2 - PIN 4 : Output 3 - PIN 5 : Output 4 - PIN 6 : Output 5 - PIN 7 : Output 6 - PIN 8 : Output 7 - PIN 9 : Return (common) - PIN 10 : Return (common) - PIN 11 : +24 VDC - PIN 12 : Chassis	M12 - 5 PINS Female  - PIN 1 : +24 VDC - PIN 2 : Odd outputs - PIN 3 : Common - PIN 4 : Even outputs - PIN 5 : n/a
Input status LED display (Logic side)	8 x Yellow / Red			4 x Yellow / Red
Backplane Bus status LED display (Logic side)	Network status : 1 x green / red Module status : 1 x green / red			

Isysnet Backplane Bus accessories



Description	Connector type	W (g)	Order code
Backplane Bus extender	1 meter	380	PSSEXT1
	3 meter	760	PSSEXT3
Terminaison module		200	PSSTERM

Connectors for inputs



Description	Connector type	W (g)	Order code
Cable quick connect connector	M8 male	25	P8CS0803J
	M12 male - A coding	25	P8CS1204J
Y shape	M12 male - 2 x M12 female	25	P8CSY1212A

Isysnet Analogue Input modules

C

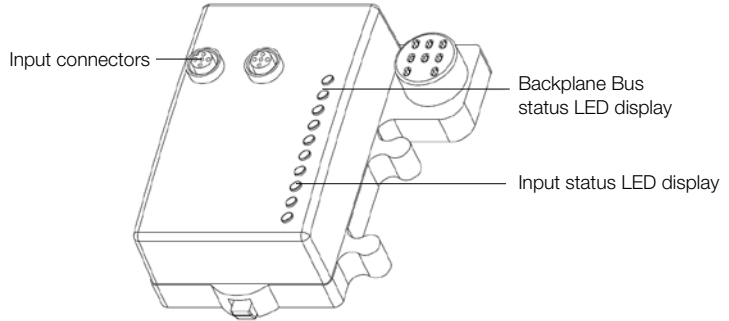

Isysnet Analogue Input modules		
Input module order code	PSSNAVM12A	PSSNACM12A
Nb of Inputs	2	2
Nb of Input connectors	2 x M12	2 x M12
Input density / connector	1	1
Input signal	0 - 10 V	4 - 20 mA
Analogue Input module connection		
Input connector	M12 - 5 PINs - Female - PIN 1 : +24 VDC - PIN 2 : Inputs - PIN 3 : Common - PIN 4 : Common - PIN 5 : n/a	
Input status LED display (Logic side)	2 x green / red	
Backplane Bus status LED display (Logic side)	Module status : 1 x green / red Network status : 1 x green / red	

Isysnet Backplane Bus accessories

Description	Cable length	W (g)	Order code
 Backplane Bus extender	1 meter	380	PSSEXT1
	3 meter	760	PSSEXT3
 Termination module		200	PSSTERM

Connectors for inputs

Description	Connector type	W (g)	Order code
 Straight connector	M12 male - A coding	25	P8CS1205BA

Isysnet Analogue Output modules

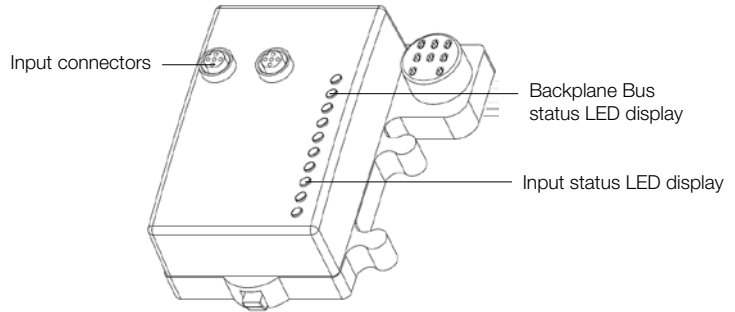

Isysnet Analogue Output modules		
Output module order code	PSSTAVM12A	PSSTACM12A
Nb of Inputs	2	2
Nb of Input connectors	2 x M12	2 x M12
Input density / connector	1	1
Input signal	0 - 10 V	4 - 20 mA
Analogue Output module connection		
Output connector	M12 - 5 PINs - Female - PIN 1 : Outputs - PIN 2 : +24 VDC - PIN 3 : Common - PIN 4 : Common - PIN 5 : n/a	
Output status LED display (Logic side)	2 x green / red	
Backplane Bus status LED display (Logic side)	Module status : 1 x green / red Network status : 1 x green / red	

Isysnet Backplane Bus accessories



Description	Cable length	W (g)	Order code
Backplane Bus extender	1 meter	380	PSSEXT1
	3 meter	760	PSSEXT3



Termination module		200	PSSTERM
--------------------	--	-----	----------------

Connectors for Outputs



P8CS1205BA

Description	Connector type	W (g)	Order code
Straight connector	M12 male - A coding	25	P8CS1205BA

Isysnet 32 Output drivers

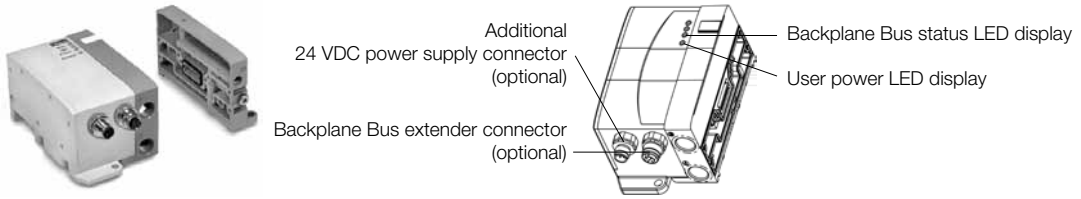

Isysnet 32 Output driver modules		Isys Micro				Isys ISO 15407-2	Isys ISO 5599-2
Dedicated valve range 32 Output driver modules order code	Side ported	PSML61AP	PSMM61AP	PSMM71AP	PSMM51AP	PS5620L61P	PS4020L61CP
	Bottom ported	PSML62AP	PSMM62AP	PSMM72AP	PSMM52AP	-	-
Pneumatic port sizes		Power supply				G3/8"	
		Exhaust				G3/8"	
Pneumatic pilot port sizes		Power supply				Internal or M7	
		Exhaust				G1/8" Internal	
32 Output driver module connection							
24 VDC power supply connector	NO	YES	YES	NO	NO	NO	NO
	 M12 - 5 PINs - Male - PIN 1 : +24 VDC - PIN 2 : n/a - PIN 3 : Common - PIN 4 : n/a - PIN 5 : Protective Earth						
Backplane Bus Extender connector	NO	NO	YES	YES	NO	NO	NO
			 M12 - 5 PINs - Female To use with PSSVEXT1 - PIN 1 : CAN SHLD - PIN 2 : CAN V+ - PIN 3 : CAN GND - PIN 4 : CAN High - PIN 5 : CAN Low				
Backplane Bus status LED display (Logic side)	Backplane Bus power supply : 1 x green / red Backplane Bus status : 1 x green / red Output fault : 1 x red Valve power supply : 1 x green				Module status : 1 x green / red Backplane Bus status : 1 x green/red Output fault : 1 x yellow / red		

Backplane Bus and Solenoid Valves Power Supply Sourcing :

Isys Micro 32 output driver modules

Isys ISO 32 output driver modules

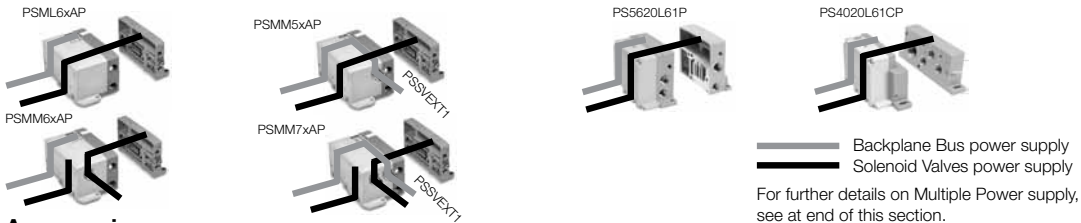



Accessories

	Description	Connector type	W (g)	Order code
	Backplane Bus extension cable with 1 meter cable	M12 male - A coding Head plate	380	PSSVEXT1
	Connector for 24 VDC power supply connector	M12 Female - A coding	25	P8CS1205AA
	Line termination	M12 Male - A coding	25	P8BPA00MA

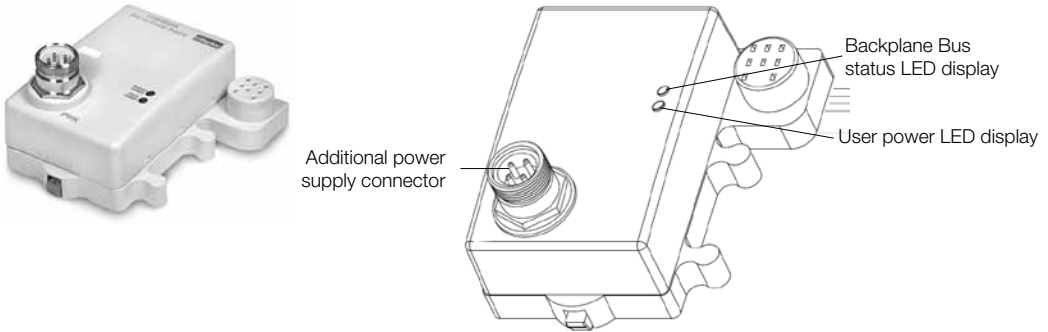
Isysnet Power Extender module



Backplane Bus Extension Power Supply module	
Power Supply Extender module Order Code	PSSE24A
	
Extender module connection	
Power supply connection	<p>7/8" - 4 PINs - Male</p> <div style="display: flex; align-items: center;">  <ul style="list-style-type: none"> - PIN 1 : User power + - PIN 2 : Backplane bus power + - PIN 3 : Backplane bus power + - PIN 4 : User power - </div>
Status LED display (Logic side)	<p>Field power status : 1 x green 5 VDC system power status : 1 x green</p>



Isysnet Backplane Bus connector



P8CS7804AA

Description	Connector type	W (g)	Order code
power supply connector	7/8" - 4 PINs	40	P8CS7804AA

Isysnet Backplane Bus accessories

Description	Cable length	W (g)	Order code
 Backplane Bus extender from Isysnet module	1 meter	380	PSSEXT1
	3 meter	760	PSSEXT3
 Backplane Bus extension cable from 32 outputs driver	1 meter	380	PSSVEXT1

DeviceNet 16 outputs communication module

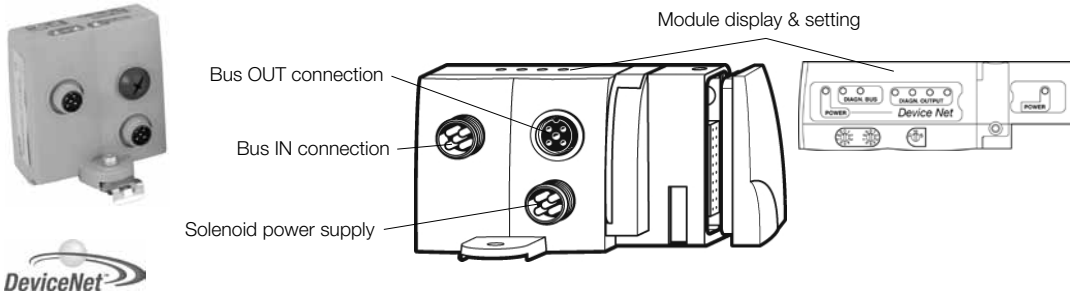

DeviceNet Adapters	Moduflex Valve System		Isys Micro
Dedicated valve range			
DeviceNet module Order Code	P2M2HBVD11600	P2M2HBVD21600	Side ported : PSMMD1AP Bottom ported : PSMMD2AP

Adapter connection	
Power supply connection	<div style="display: flex; justify-content: space-around;"> <div style="text-align: center;"> <p>M12 - 5 PINs - Male - B coding - PIN 1 : n/a - PIN 2 : n/a - PIN 3 : 0 VDC Solenoids - PIN 4 : 24 VDC Solenoids - PIN 5 : Protected earth (PE)</p> </div> <div style="text-align: center;"> <p>M12 - 5 PINs - Male - A coding - PIN 1 : n/a - PIN 2 : n/a - PIN 3 : 0 VDC Solenoids - PIN 4 : 24 VDC Solenoids - PIN 5 : Protected earth (PE)</p> </div> </div>
Bus IN connection	<div style="text-align: center;"> <p>M12 - 5 PINs - Male - A coding - PIN 1 : Drain - PIN 2 : CAN V+ - PIN 3 : CAN V- - PIN 4 : CAN High - PIN 5 : CAN Low</p> </div>
Bus OUT connection	<div style="text-align: center;"> <p>M12 - 5 PINs - Female - A coding - PIN 1 : Drain - PIN 2 : CAN V+ - PIN 3 : CAN V- - PIN 4 : CAN High - PIN 5 : CAN Low</p> </div>
LED Display	Adapter power : 1 x green DeviceNet status : 2 x green/red Solenoid pilots power : 1 x green/red Solenoid pilots diagnostic : 4 x red

Valve range adapters



Description	Valve range	W (g)	Order code	
Moduflex Bus adapter without communication module	Moduflex Valve	30	P2M2HEV0B	
	Isys Micro	Side ported	200	PSMM41AP
		Bottom ported	200	PSMM42AP
	Isys ISO 15407-2 - HA - HB	200	PS5620M41P	
	Isys ISO 5599-2 - H1	300	PS4020M41CP	

DeviceNet communication module connection accessories



Description	Connection type	W (g)	Order code
Power supply connector	M12 Female - A coding	40	P8CS1205AA
	M12 Female - B coding	40	P8CS1205AB
Bus IN connector	M12 Female - A coding	25	P8CS1205AA
Bus OUT connector	M12 Male - A coding	25	P8CS1205BA
Line terminaison	M12 Male - A coding	25	P8BPA00MA

CANopen 16 outputs communication module

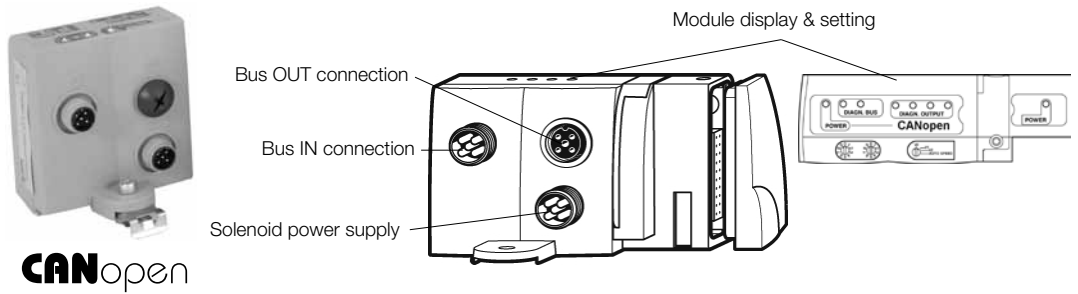

CANopen

CANopen Adapters	Modulflex Valve System		Isys Micro
Dedicated valve range			
CANopen module Order Code	P2M2HBVC11600	P2M2HBVC21600	Side ported : PSMMC1AP Bottom ported : PSMMC2AP

Adapter connection	
Power supply connection	<div style="display: flex; justify-content: space-around;"> <div style="text-align: center;"> M12 - 5 PINs - Male - B coding - PIN 1 : n/a - PIN 2 : n/a - PIN 3 : 0 VDC Solenoids - PIN 4 : 24 VDC Solenoids - PIN 5 : Protected earth (PE) </div> <div style="text-align: center;"> M12 - 5 PINs - Male - A coding - PIN 1 : n/a - PIN 2 : n/a - PIN 3 : 0 VDC Solenoids - PIN 4 : 24 VDC Solenoids - PIN 5 : Protected earth (PE) </div> </div>
Bus IN connection	<div style="text-align: center;"> M12 - 5 PINs - Male - A coding - PIN 1 : Drain - PIN 2 : CAN V+ - PIN 3 : CAN V- - PIN 4 : CAN High - PIN 5 : CAN Low </div>
Bus OUT connection	<div style="text-align: center;"> M12 - 5 PINs - Female - A coding - PIN 1 : Drain - PIN 2 : CAN V+ - PIN 3 : CAN V- - PIN 4 : CAN High - PIN 5 : CAN Low </div>
LED Display	Adapter power : 1 x green CANopen status : 2 x green/red Solenoid pilots power : 1 x green/red Solenoid pilots diagnostic : 4 x red

Valve range adapters

Description	Valve range	W (g)	Order code
 PSMMC1AP Modulflex Bus adapter without communication module	Modulflex Valve	30	P2M2HEV0B
	Isys Micro Side ported	200	PSMM41AP
	Bottom ported	200	PSMM42AP
	Isys ISO 15407-2 - HA - HB	200	PS5620M41P
	Isys ISO 5599-2 - H1	300	PS4020M41CP

CANopen communication module connection accessories

Description	Connection type	W (g)	Order code	
 P8CS1205BA	Power supply connector	M12 Female - A coding	40	P8CS1205AA
		M12 Female - B coding	40	P8CS1205AB
	Bus IN connector	M12 Female - A coding	25	P8CS1205AA
	Bus OUT connector	M12 Male - A coding	25	P8CS1205BA
	Line terminaison	M12 Male - A coding	25	P8BPA00MA

Profibus DP 16 outputs communication module

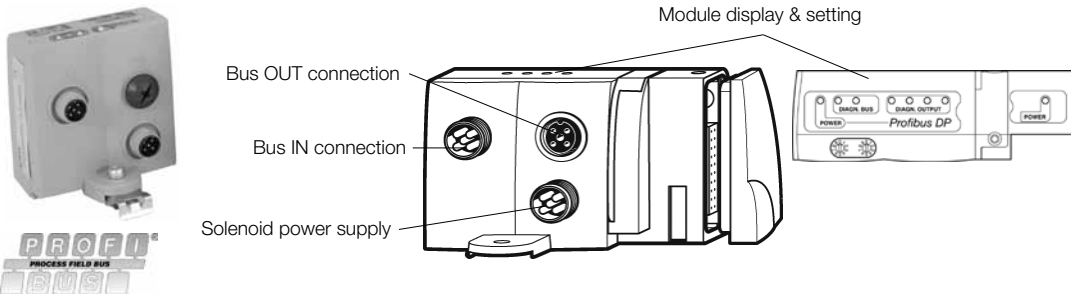

Profibus DP Adapters		
Dedicated valve range	Moduflex Valve System	Isys Micro
Profibus DP module Order Code	P2M2HBVP21600	Side ported : PSMMP1AP Bottom ported : PSMMP2AP

Adapter connection	
Power supply connection	<ul style="list-style-type: none"> M12 - 5 PINs - Male - A coding - PIN 1 : +24 VDC adapter - PIN 2 : n/a - PIN 3 : 0 VDC Adapter & Solenoids - PIN 4 : 24 VDC Solenoids - PIN 5 : Protected earth (PE)
Bus IN connection	<ul style="list-style-type: none"> M12 - 5 PINs - Male - B coding - PIN 1 : + 5 VDC Bus - PIN 2 : A - Line - PIN 3 : GND Bus - PIN 4 : B - Line - PIN 5 : Shield
Bus OUT connection	<ul style="list-style-type: none"> M12 - 5 PINs - Female - B coding - PIN 1 : + 5 VDC Bus - PIN 2 : A - Line - PIN 3 : GND Bus - PIN 4 : B - Line - PIN 5 : Shield
LED Display	Adapter power : 1 x green Profibus DP status : 2 x green/red Solenoid pilots power : 1 x green/red Solenoid pilots diagnostic : 4 x red

Valve range adapters

Description	Valve range	W (g)	Order code
PSMM41AP	Moduflex Bus adapter without communication module	30	P2M2HEV0B
	Isys Micro Side ported	200	PSMM41AP
	Bottom ported	200	PSMM42AP
	Isys ISO 15407-2 - HA - HB	200	PS5620M41P
	Isys ISO 5599-2 - H1	300	PS4020M41CP

Profibus DP communication module connection accessories

Description	Connection type	W (g)	Order code
Power supply connector	M12 Female - A coding	40	P8CS1205AA
Bus IN connector	M12 Female - B coding	25	P8CS1205AB
Bus OUT connector	M12 Male - B coding	25	P8CS1205BB
Line terminaison	M12 Male - B coding	25	P8BPA00MB

InterBus-S 16 outputs communication module

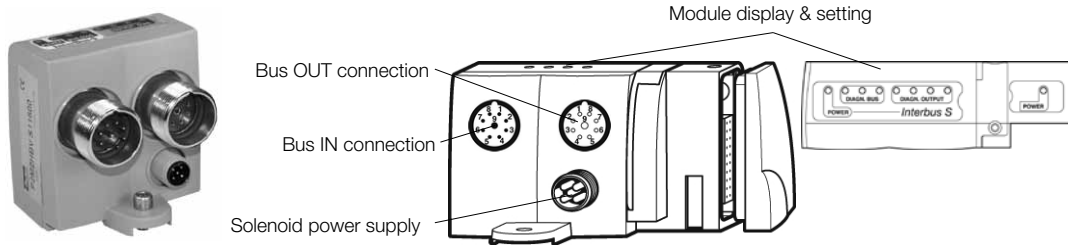

INTERBUS-S

InterBus-S Adapters		
Dedicated valve range	Moduflex Valve System	
InterBus-S module Order Code	P2M2HBVS11600	
Adapter connection		
Power supply connection		M12 - 5 PINs - Male - A coding - PIN 1 : +24 VDC adapter - PIN 2 : n/a - PIN 3 : 0 VDC Adapter & Solenoids - PIN 4 : 24 VDC Solenoids - PIN 5 : Protected earth (PE)
Bus IN connection		M23 - 9 PINs - Male: - PIN 1 : DO - PIN 6 : n/a - PIN 2 : DO - PIN 7 : n/a - PIN 3 : DI - PIN 8 : n/a - PIN 4 : DI - PIN 9 : n/a - PIN 5 : Ground
Bus OUT connection		M23 - 9 PINs - Female: - PIN 1 : DO - PIN 6 : n/a - PIN 2 : DO - PIN 7 : n/a - PIN 3 : DI - PIN 8 : n/a - PIN 4 : DI - PIN 9 : RBST - PIN 5 : Ground
LED Display	Adapter power : 1 x green Profibus DP status : 3 x green/red Solenoid pilots power : 1 x green/red Solenoid pilots diagnostic : 4 x red	

Valve range adapters

Description	Valve range	W (g)	Order code
 P8MM41AP Moduflex Bus adapter without communication module	Moduflex Valve	30	P2M2HEV0B
	Isys Micro Side ported	200	PSMM41AP
		Bottom ported	200
	Isys ISO 15407-2 - HA - HB	200	PS5620M41P
	Isys ISO 5599-2 - H1	300	PS4020M41CP

InterBus-S communication module connection accessories

Description	Connection type	W (g)	Order code
 P8CS1205AA Power supply connector	M12 Female - A coding	40	P8CS1205AA

AS-interface communication module

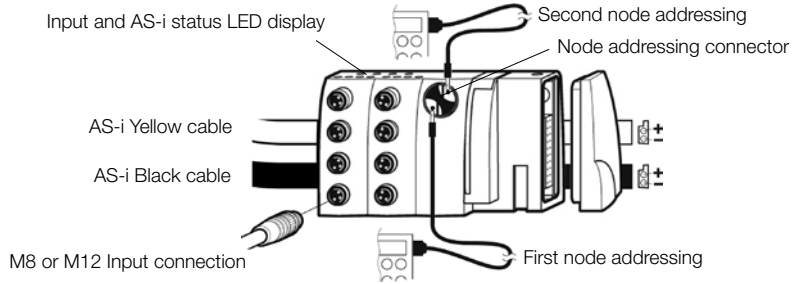

AS-i Adapters									
AS-i module Order Code	P2M2HBVA10400	P2M2HBVA10800	P2M2HBVA20600	P2M2HBVA10808A	P2M2HBVA20608A	P2M2HBVA10404B	P2M2HBVA10808B	P2M2HBVA20608B	
AS-i Version	V2.0	V2.0	V2.1	V2.0	V2.1	V2.0	V2.0	V2.1	
Number of addresses	1 / 31	2 / 31	2 / 31a + 31b	2 / 31	2 / 31a + 31b	1 / 31	2 / 31	2 / 31a + 31b	
Nb of outputs for sol. valves	4	8	6	8	6	4	8	6	
Nb of Inputs	-			8	8	4	8	8	
Nb of Input connectors	-			8 x M8	8 x M8	4 x M12	4 x M12	4 x M12	
Input density / connector	-			1	1	1	2	2	
Adapter connection									
Yellow cable	Bus signal Bus module and sensors power supply								
Black cable	24 VDC outputs for solenoid valves								
INPUTS connection				M8 - 3 PINs - Female: - PIN 1 : +24 VDC - PIN 3 : Common - PIN 4 : Input	M12 - 5 PINs - Female: PIN 1 : +24 VDC PIN 2* : Input 2&3 PIN 3 : Common PIN 4 : Input 0 to 3 PIN 5 : n/a *on left connectors only				
LED Display	Node status : 2 x green/red per node Input status : 4 x yellow per node Valve power (24V from field supply) : 1 x green / red								

Valve range adapters

Description	Valve range	W (g)	Order code	
 P8MM41AP Moduflex Bus adapter without communication module	Moduflex Valve	30	P2M2HEV0B	
	Isys Micro	Side ported	200	PSMM41AP
		Bottom ported	200	PSMM42AP
	Isys ISO 15407-2 - HA - HB	200	PS5620M41P	
	Isys ISO 5599-2 - H1	300	PS4020M41CP	

Connectors for Inputs

Description	Connection type	W (g)	Order code
 P8CS0803J Cable quick connect connector	M8 Male	25	P8CS0803J
	M12 Male - A coding	25	P8CS1204J
 P8CSY1212A "Y" shape	M12 Male - 2 x M12 Female	25	P8CSY1212A
 Addressing cable	M12 Male - Jack	100	P8LS12JACK

Isysnet modules

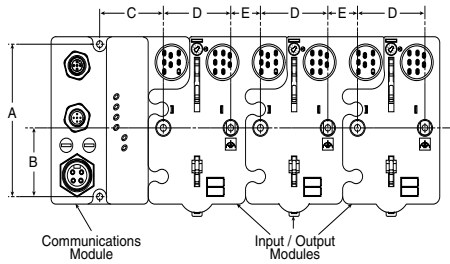

Dimensions

A	B	C
102	46	48
D	E	F
51	22	11

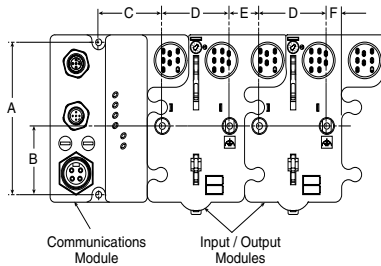

Isysnet with Isys ISO Valves

**HB-HA
 Dimensions**

A	B	E	L	G
152	137	7.5	106	68
H	H₁	J	K	L
8.4	45.8	4	110	16
M	P	W	W₁	
137	152	40.8	56.8	

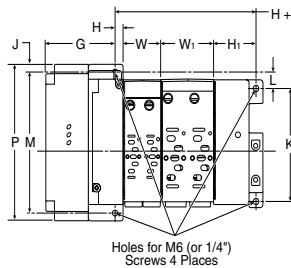

$H + H_1 + (W \times n + W_1 \times n_1)$
 n = Number of 18mm HB Bases
 n_1 = Number of 26mm HA Bases
 W = Width of 18mm HB Bases
 W_1 = Width of 26mm HA Bases

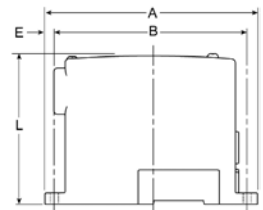

**H1
 Dimensions**

G	H	H₁	J	K
56	15.9	15.9	8.5	165
P	W			
182	49			

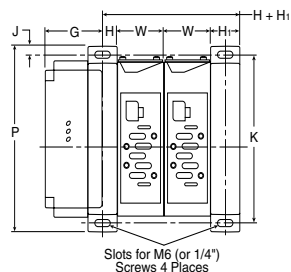

$H + H_1 + (W \times n)$
 n = Number of H1 Bases
 W = Width of H1 Bases

Isysnet with Isys Micro Valves

Side ported

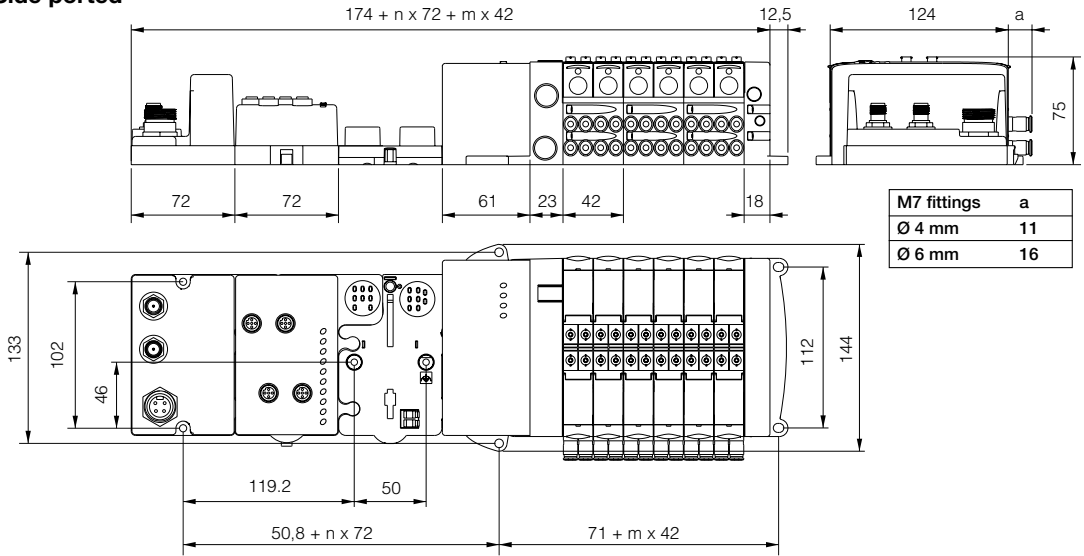

Bottom ported

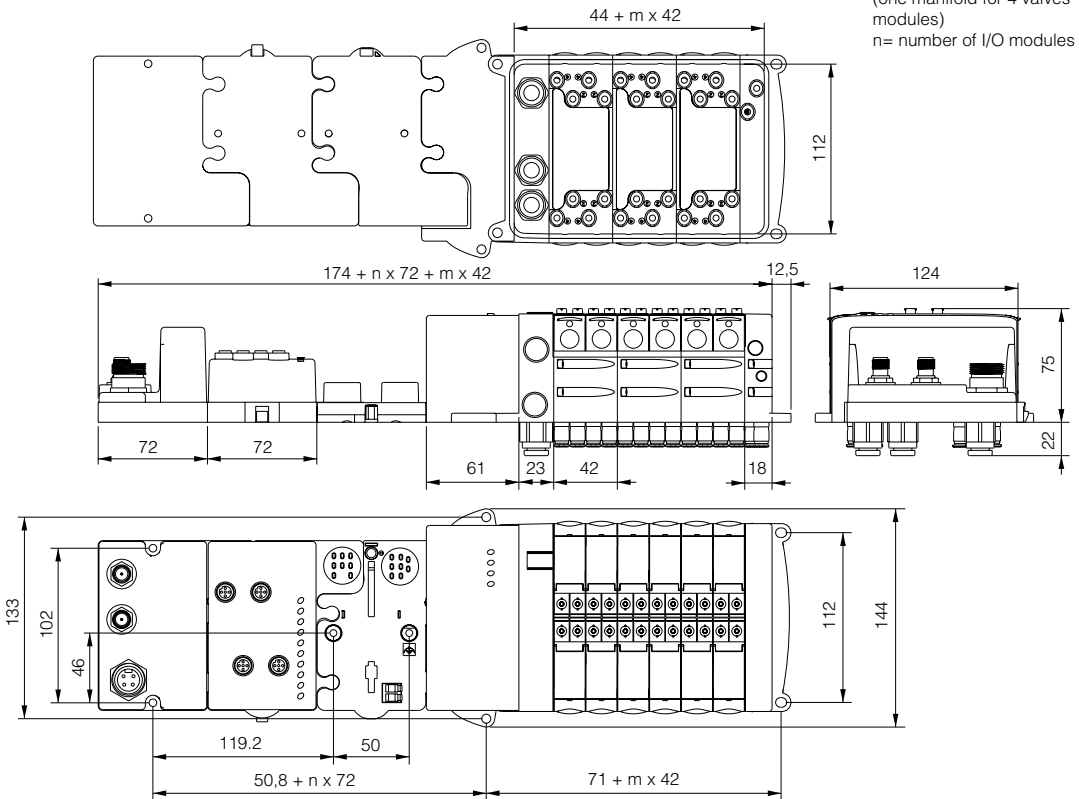

Note:
 m = number of manifolds
 (one manifold for 4 valves
 modules)
 n = number of I/O modules

Moduflex Bus with Moduflex Valve

Electrical field bus head module width : 62 mm	Head and tail pneumatic module set width : 48 mm	Modules size 1 width : 25 mm	Modules size 2 width : 37.5 mm	Intermediate module width :25 mm
---	---	---------------------------------	-----------------------------------	-------------------------------------

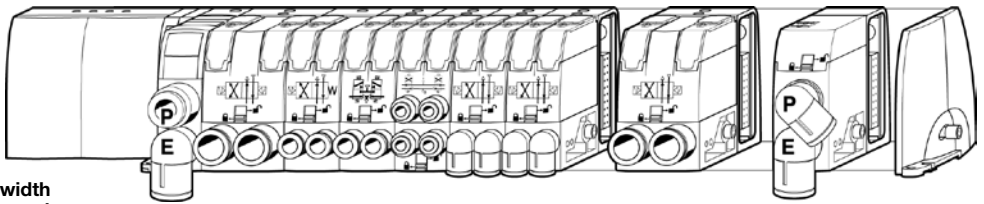

Island total width depending on valve composition

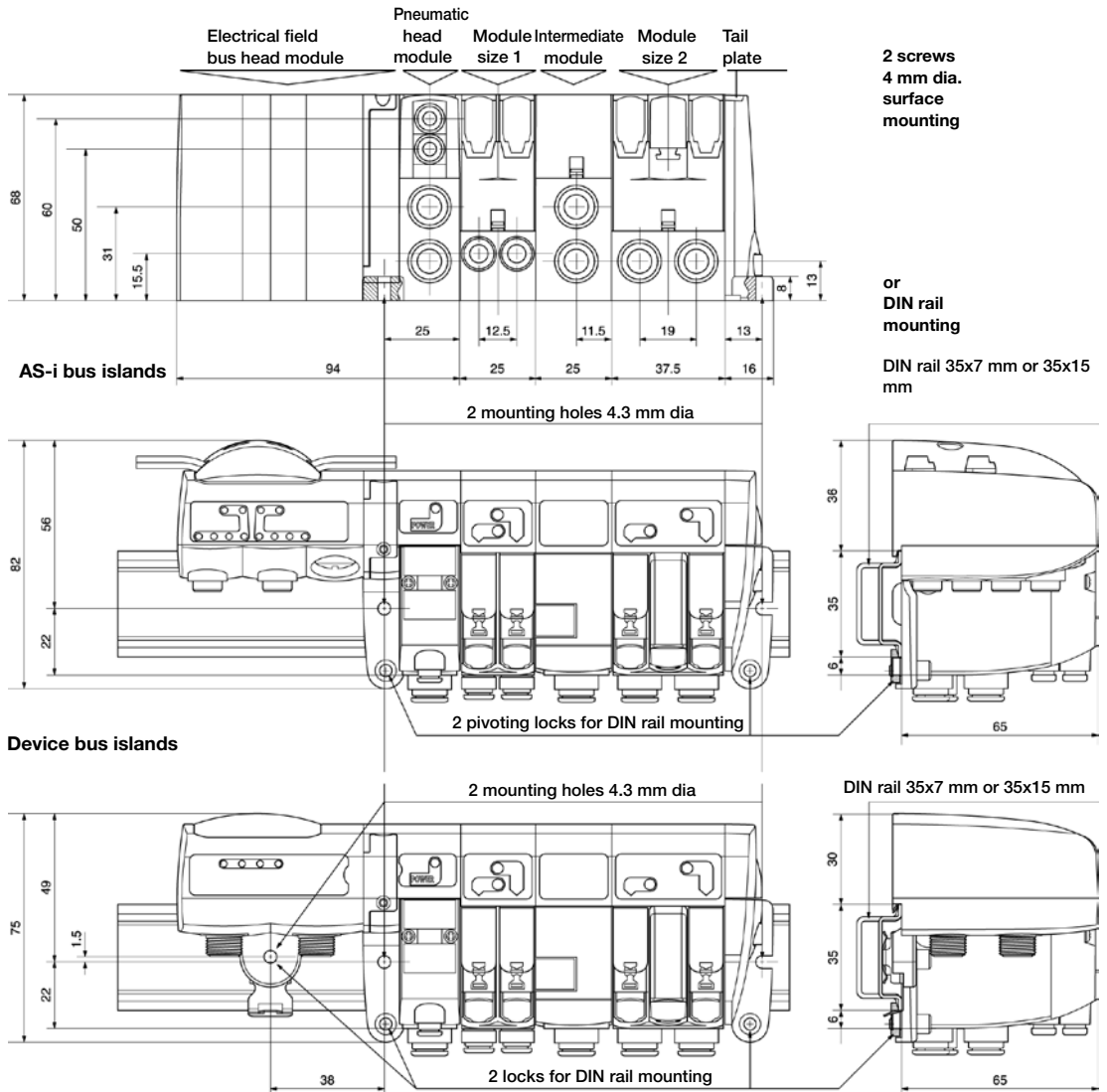

Moduflex Bus with Isys Micro Valves

Side ported

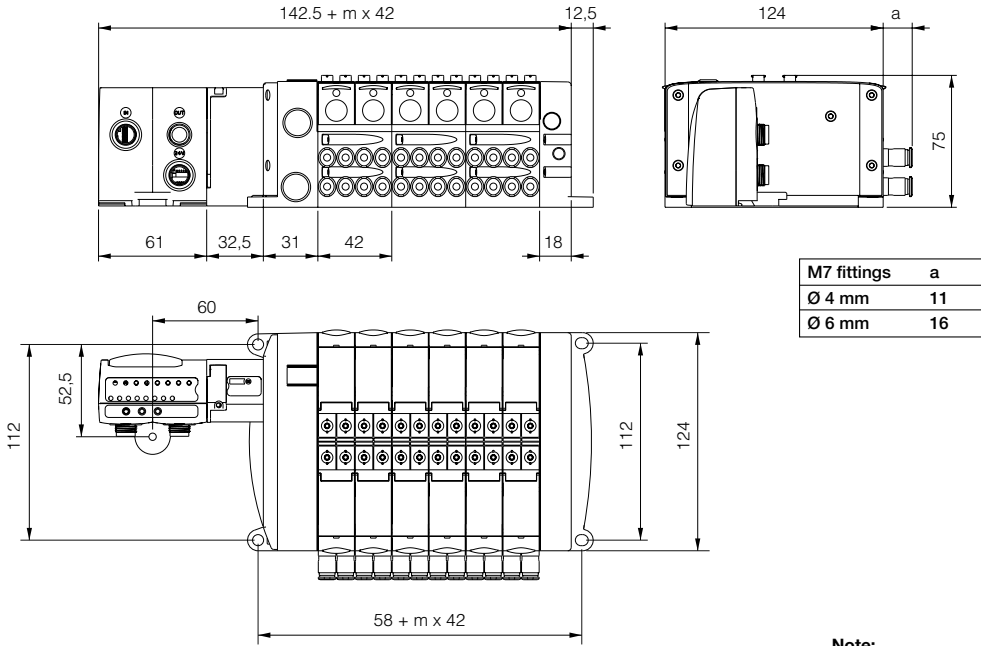

Note:
 m = number of manifolds
 (one manifold for 4 valves
 modules)

Bottom ported

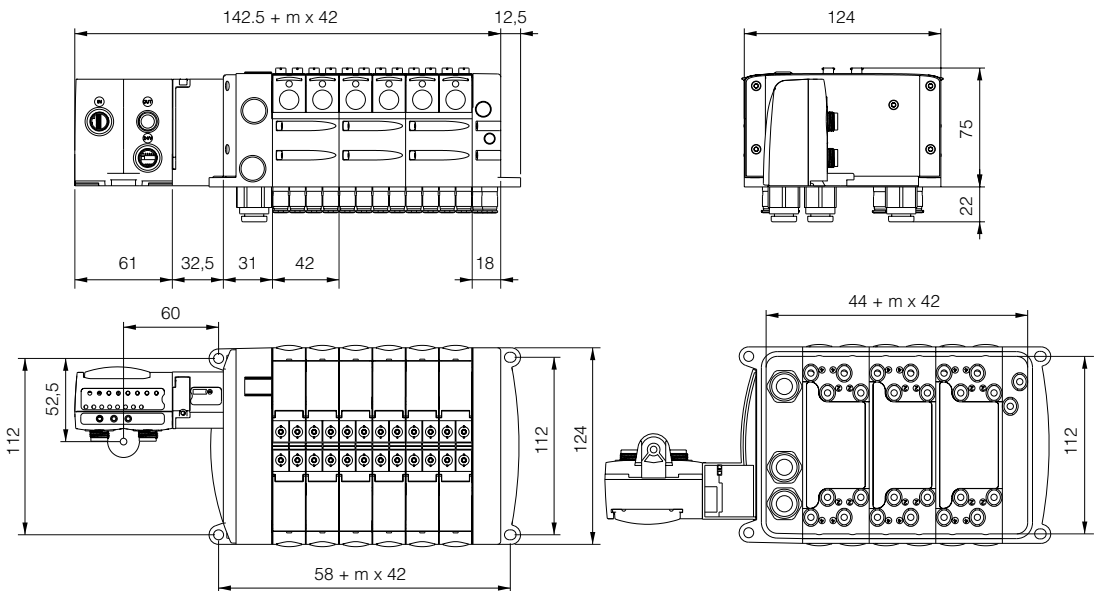



Isys Micro

Plug-in valve islands

Valve Islands for centralized application

D

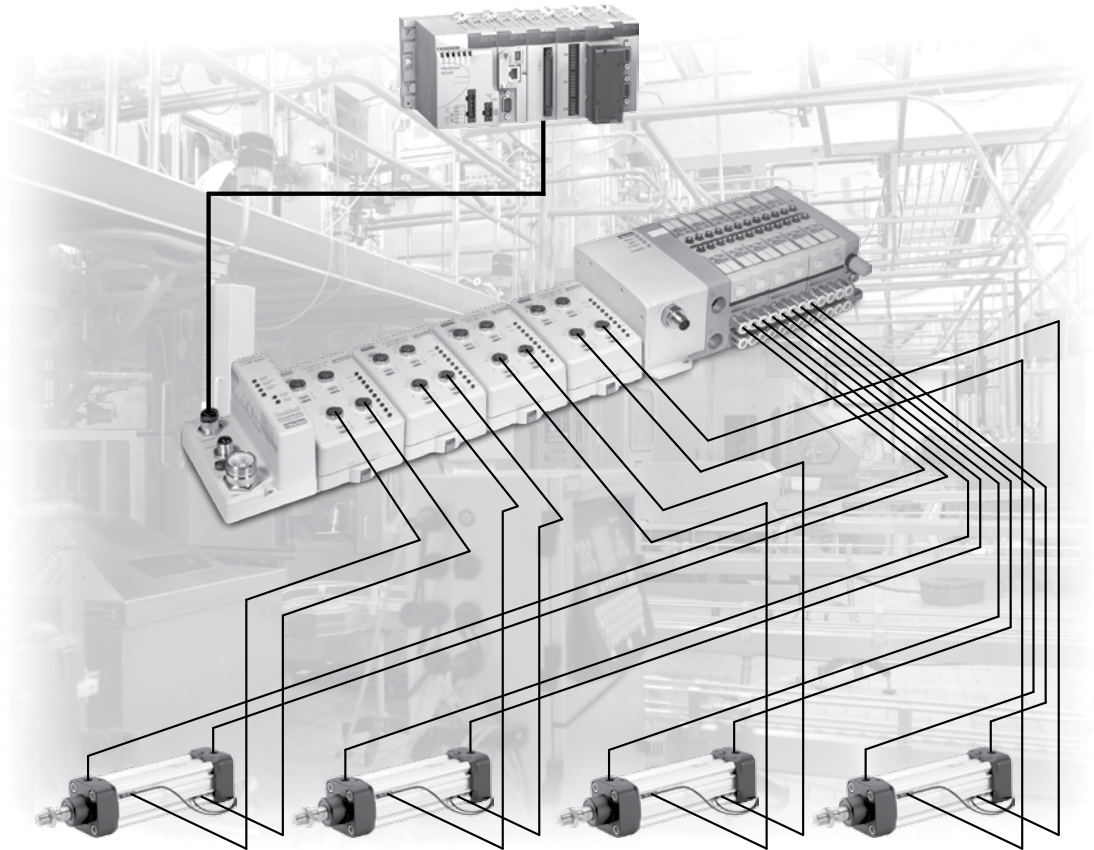

Valve islands for centralized application

Depending upon the machine configuration and design, all of the pneumatic actuators may be controlled from a centralized control panel complete with all the necessary pneumatic valves. The control valves would normally be grouped together into a 'valve island' enabling the solenoids to be electrically interconnected and in turn linked to a PLC via an industrial network. In this configuration all the sensors can be connected to either remote devices positioned around the machine or back to the centralized panel and signals transmitted to the PLC via the valve island and industrial network. Other digital or analogue I/O can be connected if required.

Valve Islands for decentralized application

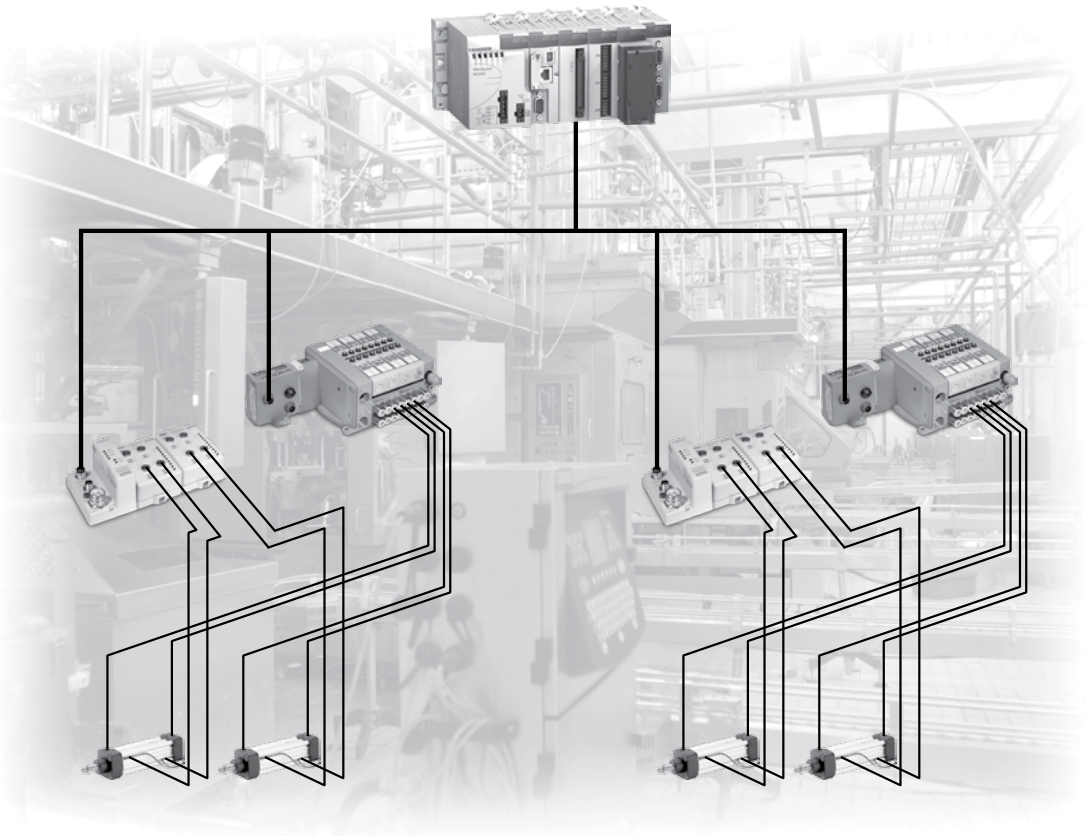

D

Valve islands for decentralized application

On larger machines where pneumatic actuators are distributed around the machine, a better solution may be to position smaller 'valve islands' closer to groups of actuators. This enables shorter runs of pneumatic tubing and can result in reduced air consumption and improved cycle times. Other digital or analogue I/O can be connected to the remote devices or directly to the PLC. All devices can be connected to the PLC using traditional wiring, multi-pole connection or an industrial network.

The Isys Micro valve redefines flexibility for pneumatic users. When either configured from basic components or ordered as pre-assembled and tested valve islands, Isys Micro valves are the answer to all your needs.



D

Solenoid operated Valve fitted with 24 VDC solenoids

Plug-in valves

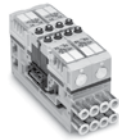
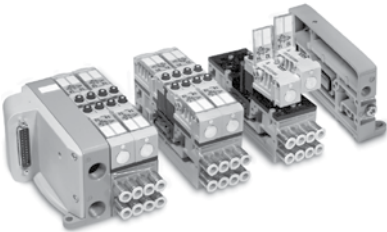

42 mm only for 4 valve modules

- Up to **8 pneumatic functions** on a **42 mm width** metal sub-base manifold.
- 4 valve modules **back to back** mounted for a compact design.
- Optimized flow with 6 mm OD tube allows 0,5 m/s speed on a 50 mm diameter cylinder with 1/4 fittings.

Optimized flow for a 6 mm OD tube

Qn = 282 NI/mn Qmax = 510 NI/mn

Side ported manifold design

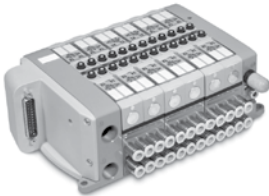

- Manifold with common ducts for ports 1, 3 and 5, outlet port 2 and 4, and supply port for 12 and 14 are available side ported.

Bottom ported manifold design



- A bottom ported design for an easy integration into an enclosure.

An easy man-machine dialogue

• Multifunction manual override

Standard non-locking manual overrides can be easily changed to locking or blocked with accessories available with valves.

• Customer identification

Have your own identification on the product protected with a transparent flip-up cover.

A quick visual diagnostic face

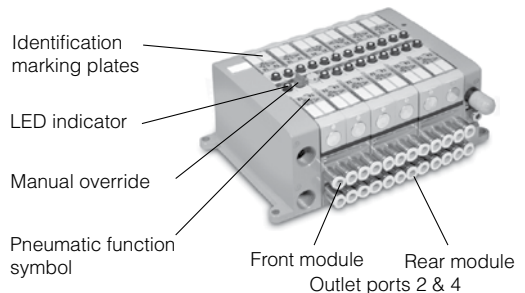

Isysnet : A centralized Fieldbus and Industrial Ethernet system

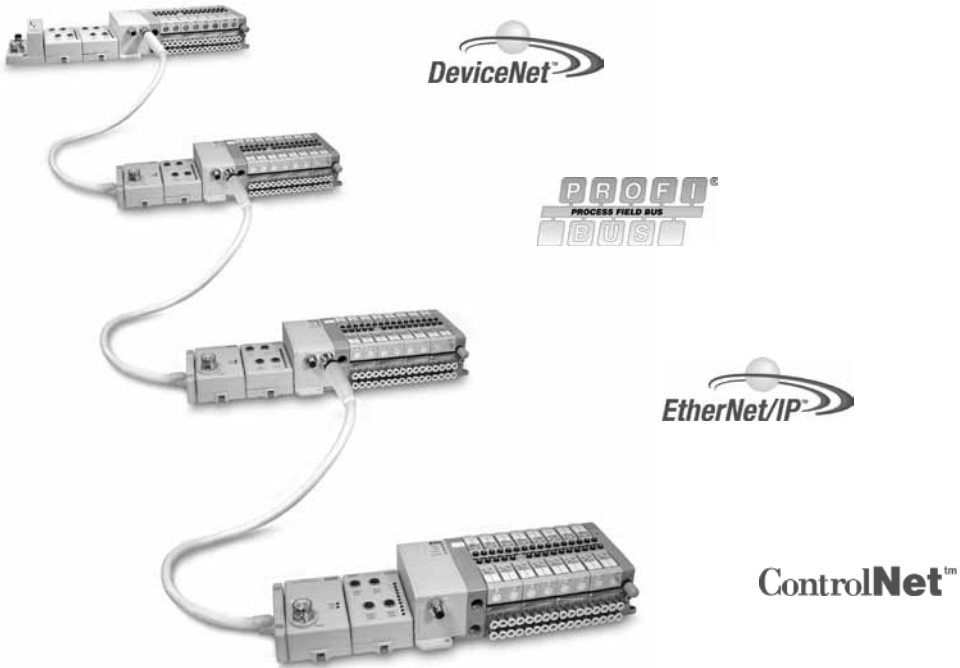

Integrated Solution

- A large Fieldbus and Industrial Ethernet communication offering for all Isys Micro range.
- Extremely fast I/O backplane uses change-of-state (COS) connections to maximise performance.
- UL, C-UL and CE certifications (as marked).

Modularity

- Ease of module replacement with unique latching mechanisms eliminating the need for screws.
- Auto Device Replacement allows OEMs to add I/O modules without making changes to the control software.
- Built-in panel grounding.
- Electronic and mechanical keying prevents users from placing I/O modules in the wrong sequence.

Communication Modules

- A Communication Module supports up to 63 I/O modules and up to 256 Inputs and 256 Outputs.

I/O Modules

- Accepts signals from sensors, photo eyes, limit switches and other field input devices.
- Provides signals to remotely operating solenoid valves and other field operating output devices.
- Choice of digital, analogue, high watt I/O Modules.
- Choose from a broad range of colour coded I/O types with connector choices of M8, M12 or M23.
- Built-in miswiring, short circuit, open circuit detection with electronic feedback.

D



Flexible in use

The Isys Micro range is fully dedicated to centralized applications where a high quantity of valves have to be concentrated in a single location.

Solenoid valve island can also be implemented with digital or analogical electrical I/O.

From a centralized application high complexity level to a basic configuration, with industrial communication or traditional multi-connection, an Isys Micro valve island can be designed.

One communication module for 256 Inputs and 256 Outputs

The combination of 32 output drivers and electrical I/O modules linked to the main communication module allows Isys Micro valve islands to drive up to 512 I/O, including up to 128 solenoids splitted between 4 interconnected devices.

Both electrical inputs and outputs modules can also be assembled either on the main or extended islands.

Expansion power supply may be used to provide additional Pointbus backplane current.

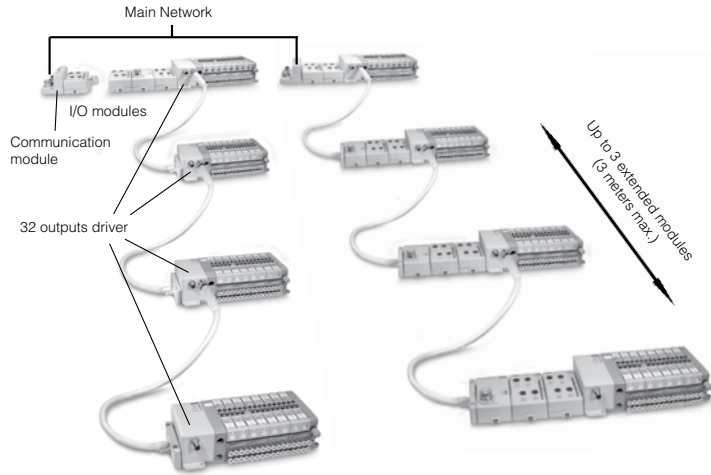

Up to 128 solenoid valves configuration

If a high quantity of valves is required in a centralized application, up to 3 extended islands can be connected to the main device communication module.

All extended islands are connected through a bus extension cable PSSVEXT1 (including 1 m cable and head plate).

In this configuration, the 32 outputs driver module, on the main island and the extended island, have to be equipped with a "bus extension" M12 connector, excepted for the last extended island.

All 32 outputs driver modules need to be equipped with a M12 solenoids power supply connector.

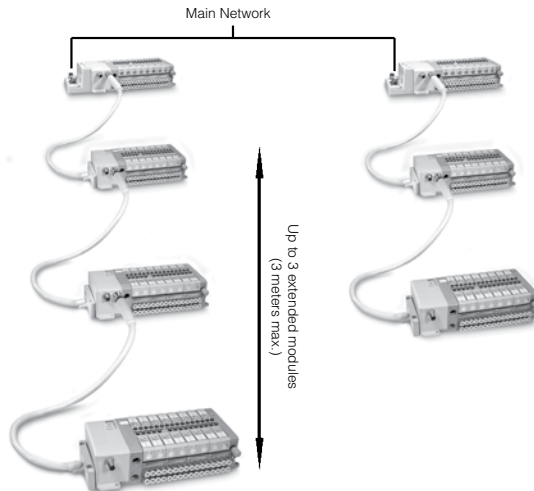

Up to 256 electrical outputs including 32 solenoid valves

Communication modules include a main 24 VDC power supply for the Bus and up to 10 digital or analogical output modules. Additional power supply is only requested if there are more than 11 output modules.

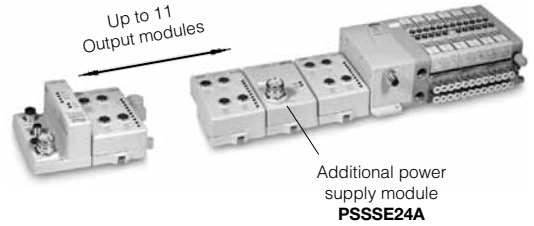

D

Up to 32 solenoid valves

Communication modules include a main 24 VDC power supply for the bus and the 32 output driver modules. All solenoids can be energized at the same time.



Island for fieldbus communication in decentralized application

In a decentralized application where a serial communication is required and only a few valves are necessary, different fieldbus protocol modules are also available.

In that case, the valve island has to be equipped with a bus communication head module adaptor.

Depending on the protocol, the head module can pilot up to 16 solenoid valves.



Island with multi-pole connection

In a decentralized application, when a multi-pole connection is required, the valve island head module can be equipped with a standard Sub-D25 connector.

With this Sub-D25 connection, up to 24 solenoid valves can be piloted.



D

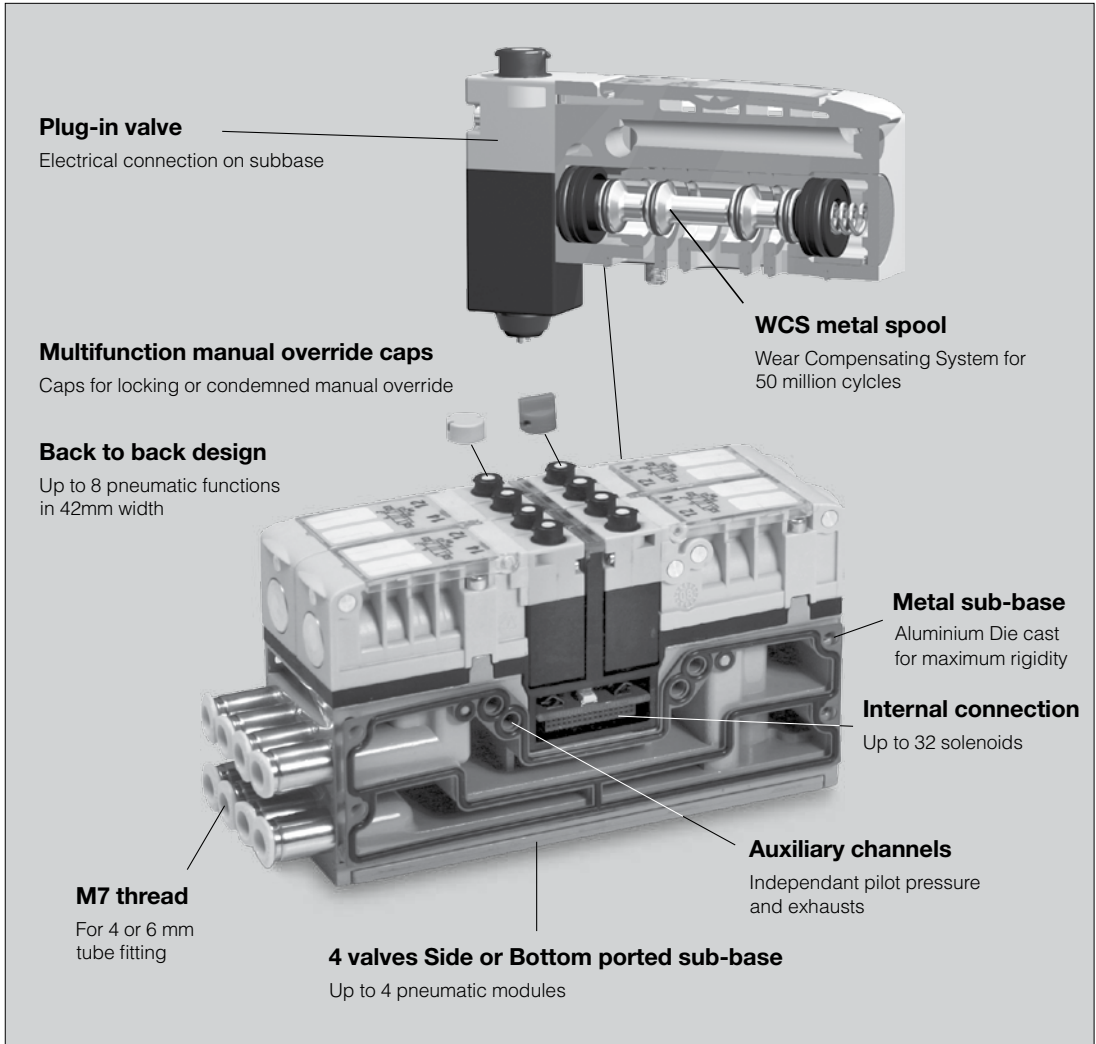

Material Specification

Valve spool :	Brass
Valve spool enclosure :	Brass
Dynamic seals :	Nitrile
Valve body :	Polyamide reinforced fibreglass
Seals :	Nitrile
Springs :	Stainless steel
Top cover :	Polyester
Subbase - End plates :	Painted aluminium

Certification

EMC / CE mark. :	According to EN 61 000-6-2
Dust & water protection :	IP65 according to EN 60529

Flow Characteristics

Dual 3/2

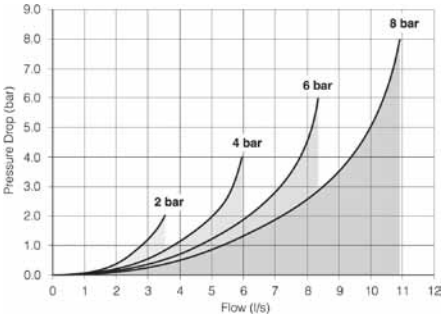

Operating pressure :	2,7 to 8,3 bar
Change-over time (side 14)	Actua. 15 ms Return 20 ms P = 6b
Change-over time (side 12)	15 ms / 25 ms P = 6b
Flow (acc. to ISO 6358) :	c = 1,2 NI/s x bar b = 0,13 Qn = 4,6 NI/s Qmax = 8,4 NI/s

5/2 single and double solenoid



Operating pressure single solenoid:	2,7 to 8,3 bar
Operating pressure double solenoid:	1,7 to 8,3 bar
Change-over time single solenoid:	Actua. 15 ms Return 25 ms P = 6b
Change-over time double solenoid:	13 ms / 13 ms P = 6b
Flow (acc. to ISO 6358) :	c = 1,2 NI/s x bar b = 0,13 Qn = 4,7 NI/s Qmax = 8,5 NI/s

5/3 all ports blocked

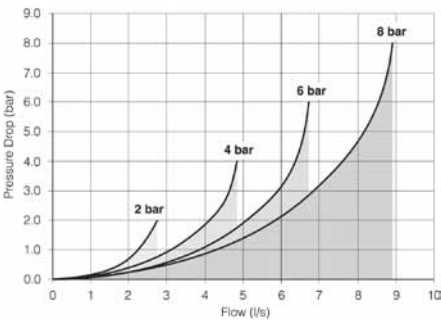

Operating pressure :	2,7 to 8,3 bar
Change-over time	Actua. 20 ms Return 20 ms P = 6b
Flow (acc. to ISO 6358) :	c = 1 NI/s x bar b = 0,14 Qn = 3,8 NI/s Qmax = 6,7 NI/s

Characteristics

Fluid :	Air or inert gas Filtered 40 µ Class 5 (according to ISO 8573-1) Dry class 4 (according to ISO 8573-1) Non-lubricated or lubricated	Operating pressure :	-0.9 to 8,3 bar with external pressure 6 bar
Storage temperature :	-40 °C to + 70 °C	Piloting pressure :	2.7 to 8.3 bar
Working temperature	-15 °C to + 50°C	Exhaust collection :	Independant exhaust collection
Vibration :	according to IEC 68-2-6 2G to 150 Hz	Rated coil voltage :	24 VDC -15 % / +10 %
Shock :	according to IEC 68-2-27 15G 11 ms	Electrical connection:	Not polarised
		Coil insulation :	Class B
		Power consumption :	1 W (42 mA) with LED
		Duty factor :	100 % at 20°C

Build your device configuration

Valve island components

D

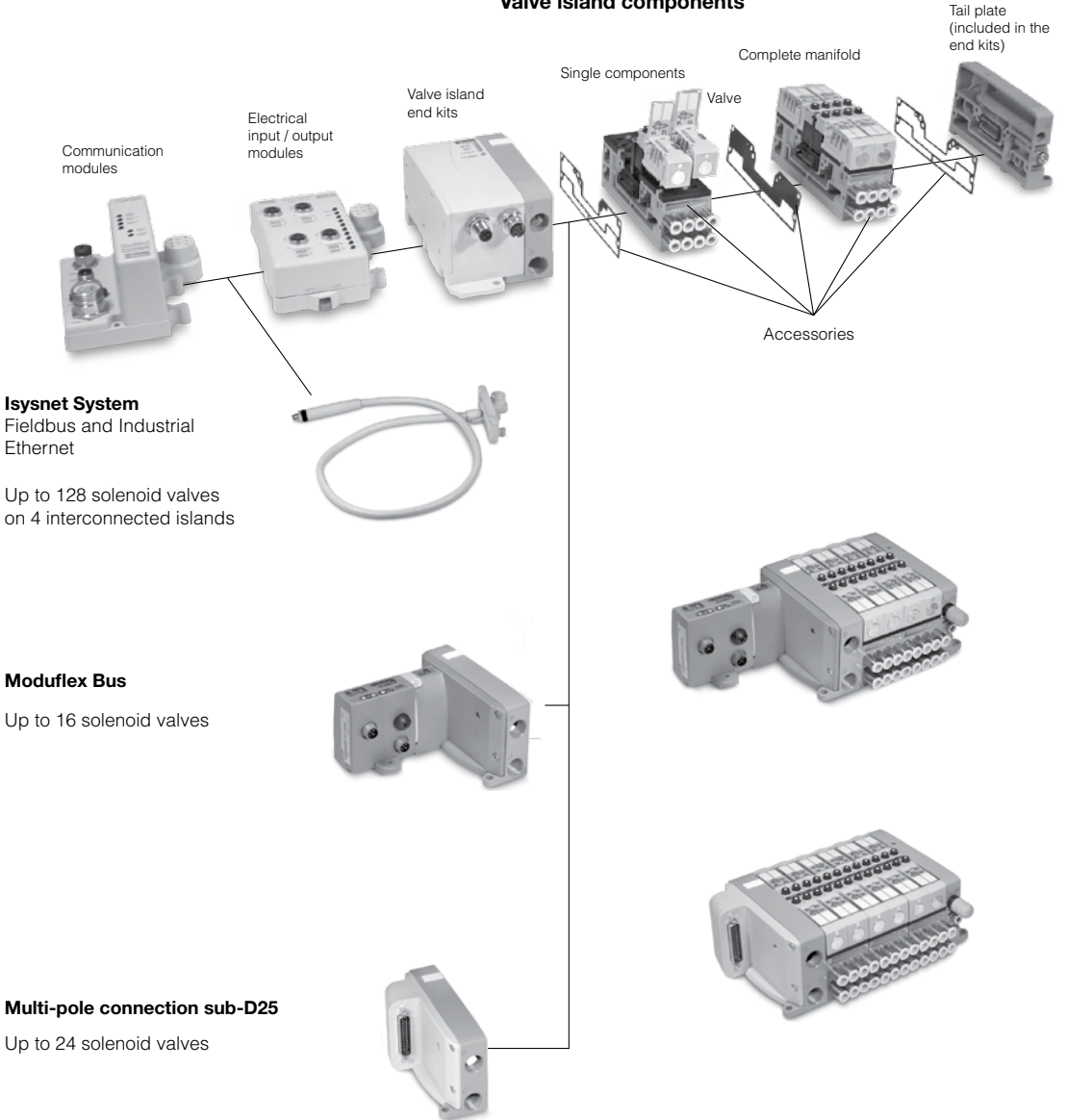

Valve island components

Manifold components:



Valve



Sub-base



Complete manifold

Fittings and accessories:



Fittings



Multi-pressure manifold seals

Isysnet components

Valve island end kits:



32 outputs drivers

Fieldbus & Industrial Ethernet modules, I/O modules and accessories:



FieldBus & Industrial Ethernet modules



Bus extender



I/O modules



Accessories

Moduflex Bus components

Valve island end kits, Fieldbus modules and accessories:



Fieldbus module



Fieldbus adaptor



Accessories

Multi-pole connection components

Sub-D25 end kits and cables:



Sub-D25 end kits



Cables

Valve ordering chart

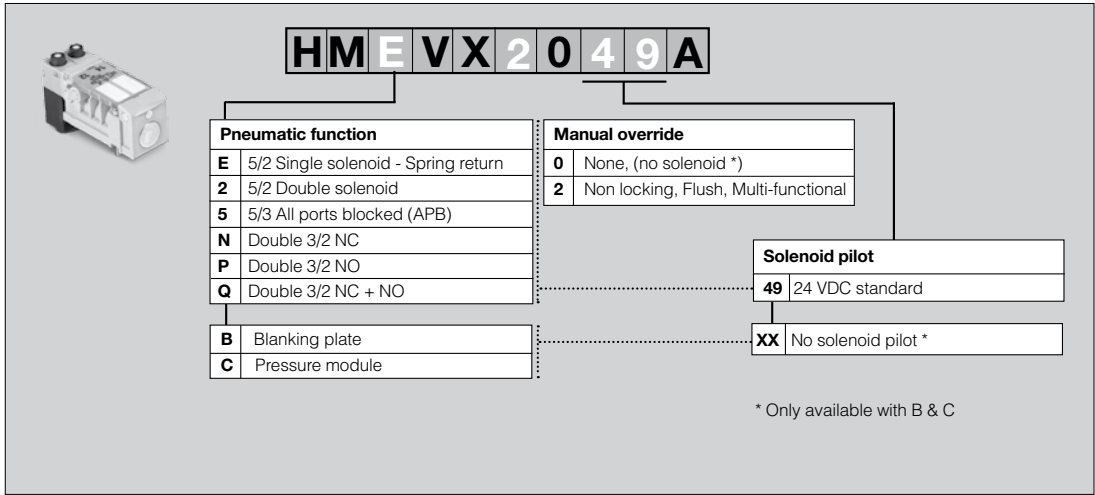

HMEVX2049A

Pneumatic function		Manual override	
E	5/2 Single solenoid - Spring return	0	None, (no solenoid *)
2	5/2 Double solenoid	2	Non locking, Flush, Multi-functional
5	5/3 All ports blocked (APB)		
N	Double 3/2 NC		
P	Double 3/2 NO		
Q	Double 3/2 NC + NO		
B	Blanking plate		
C	Pressure module		

Solenoid pilot	
49	24 VDC standard
XX	No solenoid pilot *

* Only available with B & C

Manifold ordering chart (without valve module and fitting)

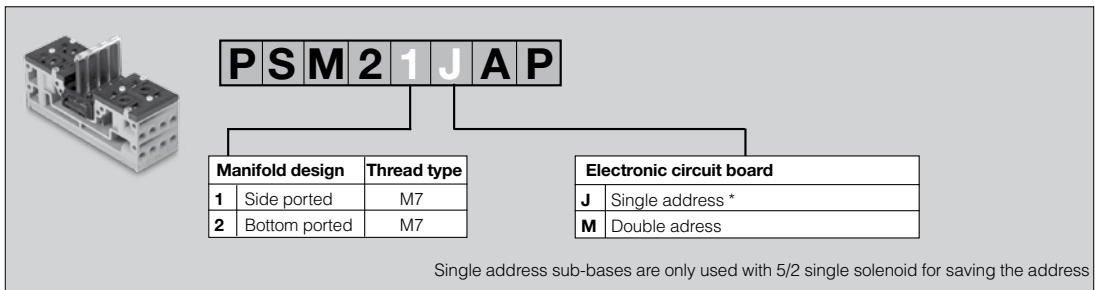

PSM21JAP

Manifold design	Thread type	Electronic circuit board	
1	Side ported	J	Single address *
2	Bottom ported	M	Double address

Single address sub-bases are only used with 5/2 single solenoid for saving the address

Manifold ordering chart (complete with valve modules and/or fittings)

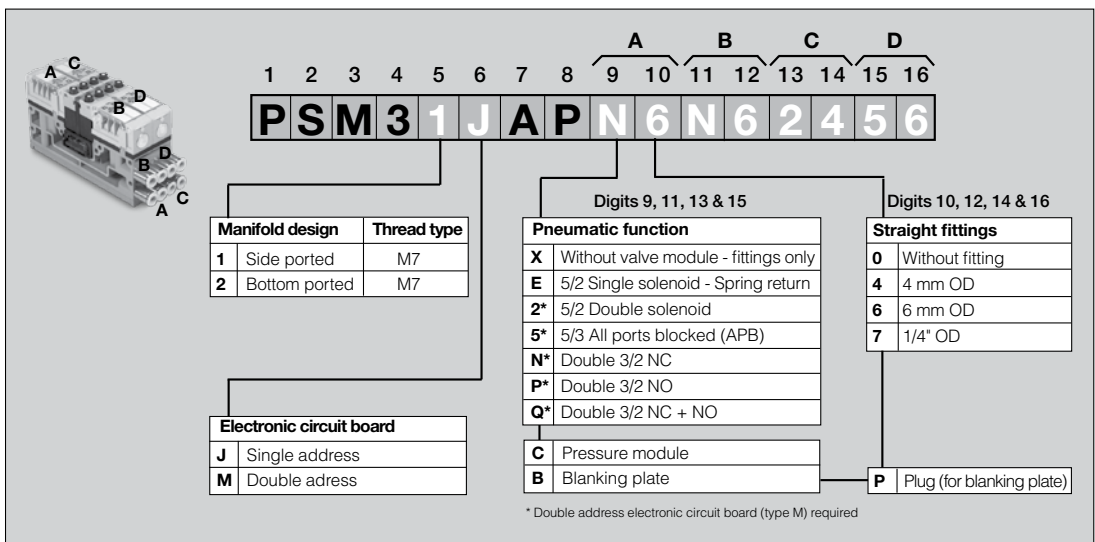

PSM31JAPN6N62456











Manifold design	Thread type	Electronic circuit board	
1	Side ported	J	Single address
2	Bottom ported	M	Double address

Pneumatic function		Straight fittings	
X	Without valve module - fittings only	0	Without fitting
E	5/2 Single solenoid - Spring return	4	4 mm OD
2*	5/2 Double solenoid	6	6 mm OD
5*	5/3 All ports blocked (APB)	7	1/4" OD
N*	Double 3/2 NC		
P*	Double 3/2 NO		
Q*	Double 3/2 NC + NO		
C	Pressure module		
B	Blanking plate	P	Plug (for blanking plate)



Digits 9, 11, 13 & 15: Pneumatic function
 Digits 10, 12, 14 & 16: Straight fittings

* Double address electronic circuit board (type M) required











Solenoid operated valve fitted with 24 VDC solenoid

	Symbol	Description	Weight (g)	Order code
 <p>Including multi-function manual override cap</p>		Double 3/2 NC + NC	60	HMN VX2049A
		Double 3/2 NO + NO	60	HMPVX2049A
		Double 3/2 NC + NO	60	HMQVX2049A
		5/2 single solenoid - Spring return	49	HMEVX2049A
		5/2 double solenoid	60	HM2VX2049A
		5/3 all ports blocked (APB)	65	HM5VX2049A
		Blanking module kit (including two M7 plugs for manifold)	30	HMBVX00XXA
		Additional pressure module	30	HMCVX00XXA

Metal manifold for 4 valves (M7 threaded)

	Description	Weight (g)	Order code
 <p>Side ported</p>	4 position manifold single electrical address	332	PSM21JAP
	4 position manifold double electrical address	332	PSM21MAP
 <p>Bottom ported</p>	4 position manifold single electrical address	310	PSM22JAP
	4 position manifold double electrical address	310	PSM22MAP

Complete manifold without fitting (M7 threaded)

	Symbol	Description	Weight (g)	Order code
 <p>Side ported</p>		4 x Double 3/2 NC + NC	572	PSM31MAPN0N0N0N0
		4 x 5/2 single solenoid - Spring return	528	PSM31JAPE0E0E0E0
		4 x 5/2 double solenoid	572	PSM31MAP20202020
		4 x 5/3 all ports blocked (APB)	592	PSM31MAP50505050
 <p>Bottom ported</p>		4 x Double 3/2 NC + NC	550	PSM32MAPN0N0N0N0
		4 x 5/2 single solenoid - Spring return	506	PSM32JAPE0E0E0E0
		4 x 5/2 double solenoid	550	PSM32MAP20202020
		4 x 5/3 all ports blocked (APB)	570	PSM32MAP50505050

Multi-pressure Manifold with blocking plates

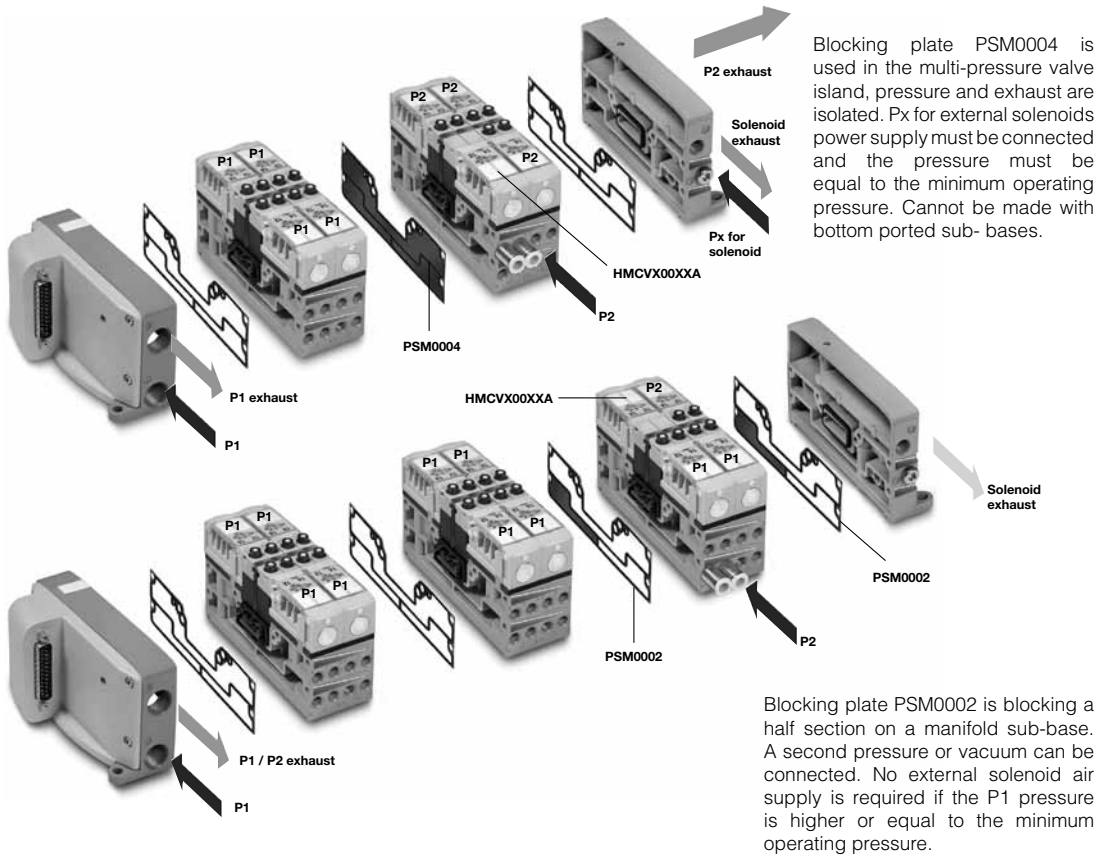



Auxiliary pressure for solenoid pilots and Exhaust channel

All end plates are delivered with an internal solenoid power supply version and can be easily changed to external solenoid power supply by simply moving a plug, if the main pressure is below the minimum operating pressure.

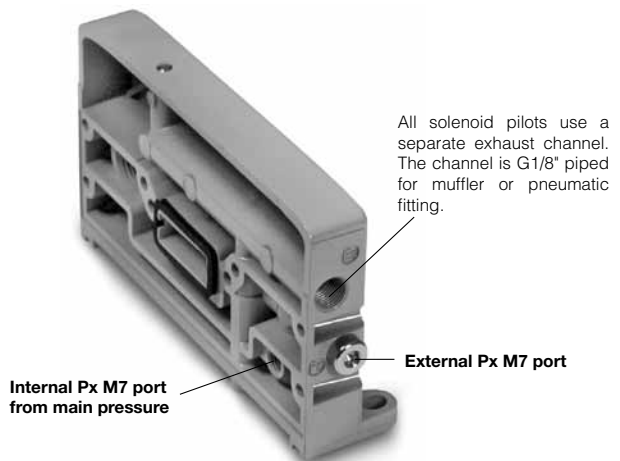
Auxiliary pressure supply port for solenoid pilot : This is a M7 port. The internal pilot supply end plate version includes an M7 plug. To change from internal supply to external supply mode, remove the plug and screw it into the internal Px port.



Pneumatic accessories

	Description	Size	Tube OD	Material	Order code
	Straight pneumatic connector for sub-base and Px	M7	4 mm	Metal	F28PMB4M7MD
		M7	6 mm	Metal	F28PMB6M7MD
	Straight pneumatic connector for Ex	1/8"	6 mm	Metal	F4PMB6-1/8
		3/8"	8 mm	Metal	F4PB8-3/8
	Straight pneumatic connector for Pressure and Exhaust ports	3/8"	10 mm	Metal	F4PB10-3/8
		3/8"	12 mm	Metal	F4PB12-3/8
	Muffler for Ex	1/8"		Metal	ESB12MC
		1/8"		Plastic	P6M-PAB1
	Muffler for exhaust port	3/8"		Metal	ESB37MC

Multi-pressure inter-manifold seal plate

	Description	Pressure port	Exhaust port	Weight (g)	Order code
	Inter-manifold seal plate	Passing / Passing	Passing	16	PSM0001
		Passing / Block	Passing	20	PSM0002
		Passing / Block	Block	30	PSM0003
		Block / Block	Block	40	PSM0004

Spare parts

	Description	Weight (g)	Order code
	24 VDC Pilot solenoid with screws	11	PSM0010
	Set of 10 multifunction manual override caps	15	PSM0011
	Set of 5 valve manifold gaskets and 10 screws	25	PSM0012
	Set of 10 M7 plugs for auxiliary pressure selection	30	PSM0013
	Set of 10 labels (in the P/N, x has to be replaced with the valve function letter, see page 14)	5	PSM002x
	Set of 10 manifold to manifold M3 screws	20	PSM0014

Isysnet 32 output driver end modules ordering chart

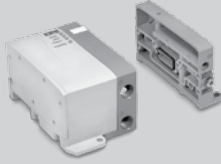

P

S

M

L

6

1

A

P

ISYSNET 32 Output driver end modules		
	24 VDC power supply connector	Extender bus connector
L6	NO	NO
M5	NO	YES
M6	YES	NO
M7	YES	YES

	Ported design	Thread type
1	Side ported	3/8" BSPP
2	Bottom ported	3/8" BSPP
5	Side ported	3/8" NPT
6	Bottom ported	3/8" NPT

32 outputs driver selection guide :

L6 type

- Isysnet 32 outputs driver with internal solenoids power supply from the communication head module
- Extended valve island not possible

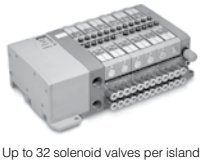

M6 type

- Isysnet 32 outputs driver with external solenoids power supply by M12 male connector
- Extended valve island not possible



M7 type

- Isysnet 32 outputs driver with external solenoids power supply by separated M12 male connector
- Extended Bus link connection for additional valve islands by separate M12 female connector



M5 type

- Isysnet 32 outputs driver with internal solenoids power supply from the communication head module
- Extended Bus link connection for additional valve islands by separate M12 female connector



Isysnet bus extender

Isysnet bus extender communication 1 meter cable for instant valve island plug-in by M12 male connector and direct head connection plate on Isysnet device

Every extended island has to be separately power supplied

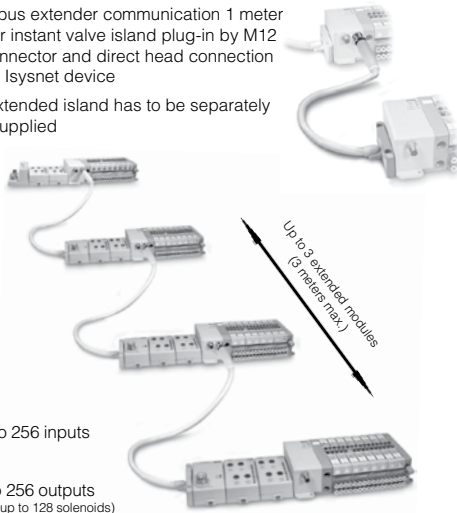





Technical data

Isysnet 32 Outputs driver modules

- Number of Outputs : 32
- Operating Voltage Range : 20,4 to 26.4 VDC
- Output current rating Nom. : 50 mA per chanel (100 mA Max)
3.2A per module
- Pointbus current : 200 mA
- Working temperature : -15°C to 50°C
- Dust and water protection : IP65

Isysnet 32 outputs driver modules

	Sub-base design	Thread type	24 VDC power supply	Extender bus	Weight (g)	Order code
	Side ported	3/8" BSPP	NO	NO	400	PSML61AP
	Bottom ported	3/8" BSPP	NO	NO	400	PSML62AP
	Side ported	3/8" BSPP	YES	NO	400	PSMM61AP
	Bottom ported	3/8" BSPP	YES	NO	400	PSMM62AP
	Side ported	3/8" BSPP	NO	YES	400	PSMM51AP
	Bottom ported	3/8" BSPP	NO	YES	400	PSMM52AP
	Side ported	3/8" BSPP	YES	YES	400	PSMM71AP
	Bottom ported	3/8" BSPP	YES	YES	400	PSMM72AP

Isysnet bus extender

	Description	Weight (g)	Order code
	Head plate 1 meter cable / M12 male connector for extended island inter-connection	380	PSSVEXT1

D

D

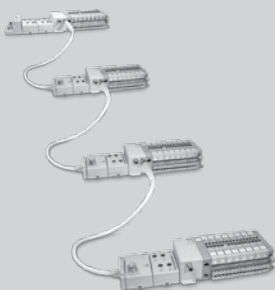

Communication modules :

- Fieldbus
- Industrial Ethernet

Digital and Analogical I/O modules
 Extended power supply module
 IP67 modules

Isysnet Communication and I/O modules

Isysnet Communication modules

Isysnet communication modules are available in :

- DeviceNet
- Profibus DP
- Ethernet I/P
- ControlNet



Digital or Analogical electrical I/O modules

Some modules have diagnostic features, electronic fusing, or individually isolated inputs/ outputs. The Isysnet family provides a wide range of input and output modules to span many applications, from highspeed discrete to process control. Isysnet supports producer/consumer technology, which allows input information and output status to be shared among multiple Logix controllers.



Isysnet Extension Power Unit

The auxiliary power supports up to 10 I/O modules and 32 output driver with a maximum of 10 A field power. The 24 VDC extension power unit (PSSSE24A) extends the backplane bus power to support up to 10 more I/O modules. Connect additional extension power units to expand the I/O assembly up to 63 I/O modules

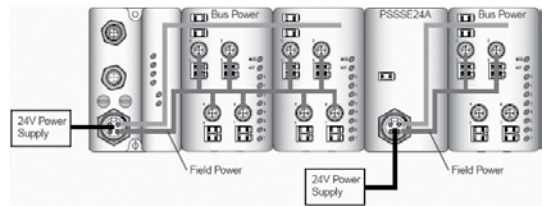

Technical data

Isysnet Communication modules & Extension power unit

Bus power supply : 24 VDC at 400 mA
 Power supply input voltage : 24 VDC
 Operative voltage range : 10 to 28.8 VDC
 Input overvoltage protection : Reverse polarity protected

Isysnet Analogue Input modules

Number of Outputs : 2
 Input signal Range : 4 to 20 mA / 0 to 10 VDC
 Pointbus current : 75 mA

Isysnet Analogue Output modules

Number of Outputs : 2
 Input signal Range : 4 to 20 mA / 0 to 10 VDC
 Pointbus current : 75 mA

Isysnet Digital Input modules

Number of Outputs : 8 – PNP or NPN
 Operating Voltage Range : 10 to 28.8 VDC
 Input current on-state : 2 to 5 mA
 Input current off-state : 1,5 mA
 Pointbus current : 75 mA

Isysnet Digital Output modules

Number of Outputs : 8
 Operating Voltage Range : 10 to 28.8 VDC
 Output current rating Max. : 1 A per channel
 3 A per module
 Pointbus current : 75 mA

Isysnet Relay Output modules

Number of Outputs : 4 – NO contacts
 Operating Voltage Range : 5 to 28.8 VDC
 Output current rating Max. : 2 A per channel
 8 A per module
 Pointbus current : 90 mA





Isysnet communication modules

	Description	Fieldbus connection	Power supply connector	Weight (g)	Order code
	DeviceNet	M18	7/8" - 4 pins	400	PSSCDM18PA
		M12 - A coding	7/8" - 4 pins	400	PSSCDM12A
	Profibus DP	M12 - B coding	7/8" - 5 pins	380	PSSCPBA
	Ethernet I/P	M12 - D coding	7/8" - 4 pins	380	PSSCENA
	ControlNet	M12 - D coding	7/8" - 4 pins	380	PSSCCNA

Isysnet bus extender

	Description	Weight (g)	Order code
	Head plate with 1 metre cable / M12 male connector for extended island interconnection	380	PSSVEXT1





Isysnet electrical I/O modules

	Description	Polarity	Connector type	Weight (g)	Order code
	8 Digital Inputs	PNP	8 x M8	400	PSSN8M8A
			4 x M12	380	PSSN8M12A
	8 Digital Outputs	NPN	8 x M8	400	PSSP8M8A
			4 x M12	380	PSSP8M12A
	8 Digital Outputs	PNP	8 x M8	400	PSST8M8A
			4 x M12	380	PSST8M12A
	4 Digital Outputs	Relay	4 x M12	410	PSSTR4M12A
			2 Analogue Inputs	0 - 10 V	2 x M12
	2 Analogue Outputs	4 - 20 mA	2 x M12	400	PSSNACM12A
			0 - 10 V	2 x M12	400
		4 - 20 mA	2 x M12	400	PSSTACM12A

Isysnet auxiliary electrical modules

	Description	Connector type	Weight (g)	Order code
	Termination module	-	200	PSSTERM
	24 VDC expansion power unit	7/8" - 4 pins	420	PSSSE24A
	1 metre cable 24 VDC	-	380	PSSEXT1
	3 metre cable 24 VDC	-	760	PSSEXT3

Isysnet accessories

	Description	Bus protocol	Connector type	Weight (g)	Order code
	Power supply connector	DeviceNet, ControlNet & Ethernet	7/8" - 4 pins	40	P8CS7804AA
		Profibus DP	7/8" - 5 pins	40	P8CS7805AA
	Line termination	DeviceNet	M12 - A coding	25	P8BPA00MA
		Profibus DP	M12 - B coding	25	P8BPA00MB
	Bus IN female connector	DeviceNet	M12 - A coding	25	P8CS1205AA
	Profibus DP	M12 - B coding	25	P8CS1205AB	
	Bus OUT male connector	DeviceNet	M12 - A coding	25	P8CS1205BA
	Profibus DP	M12 - B coding	25	P8CS1205BB	
	Cable quick connect connector		M8	25	P8CS0803J
	"Y" shape, thread to thread		M12 - A coding	25	P8CS1204J
			M12 - 2 x M12	25	P8CSY1212A

16 Outputs Moduflex Bus ends module adaptor

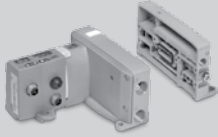

P	S	M	M	C	1	A	P
---	---	---	---	---	---	---	---

Moduflex 16 Outputs adaptor		Ported design		Thread type	
M4	Adaptor without bus module	1	Side ported		3/8" BSPP
MC	Adaptor with CANopen module	2	Bottom ported		3/8" BSPP
MD	Adaptor with DeviceNet module	5	Side ported		3/8" NPT
MP	Adaptor with Profibus DP module	6	Bottom ported		3/8" NPT

For AS-i communication, use M4 and see Moduflex Valve catalogue for AS-i module part number.

Moduflex Bus 16 Outputs

16 solenoids fieldbus modules available in DeviceNet, CANopen, and Profibus DP protocols.

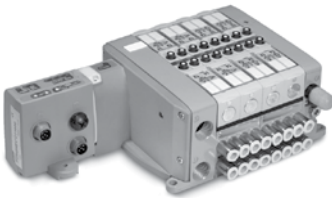

Closer to the cylinder

Decentralized application when solenoid valves have to be closer to the pneumatic actuators.

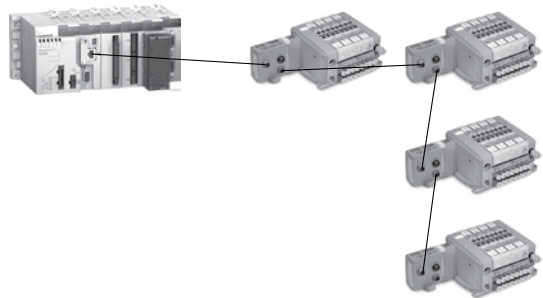

Technical data

Moduflex Bus communication modules

- Bus power supply : 20 to 30 VDC
- Power supply output voltage : 24 VDC
- Module consumption :
 - DeviceNet : 1,5 W
 - CANopen : 1,5 W
 - Profibus DP : 1,5 W
- Water and dust Protection : IP65
- Output protection : overload protected

Moduflex Bus modules





Description	Bus protocol	Sub-base design	Thread type	Weight (g)	Order code
	Moduflex Bus module	Side ported	3/8" BSPP	250	PSMMC1AP
		Bottom ported	3/8" BSPP	250	PSMMC2AP
	DeviceNet	Side ported	3/8" BSPP	250	PSMMD1AP
		Bottom ported	3/8" BSPP	250	PSMMD2AP
	Profibus DP	Side ported	3/8" BSPP	250	PSMMP1AP
		Bottom ported	3/8" BSPP	250	PSMMP2AP

Also available, AS-i interface protocol, standard version or extended version (A - B coded). See Moduflex Valve catalogue.

	End modules adaptor without Moduflex Bus module	All	Side ported	3/8" BSPP	200	PSMM41AP
			Bottom ported	3/8" BSPP	200	PSMM42AP

For configuration files, go to : <http://www.parker.com/pneu/moduflex>.

Decentralized Device bus accessories

Description	Bus protocol	Connector type	Weight (g)	Order code	
	Power supply female straight connector	All	M12 - A coding	25	P8CS1205AA
	Line termination	DeviceNet CANopen	M12 - A coding	25	P8BPA00MA
		Profibus DP	M12 - B coding	25	P8BPA00MB
	Bus IN female connector	DeviceNet CANopen	M12 - A coding	25	P8CS1205AA
		Profibus DP	M12 - B coding	25	P8CS1205AB
		DeviceNet CANopen	M12 - A coding	25	P8CS1505BA
	Bus OUT male connector	Profibus DP	M12 - B coding	25	P8CS1205BB
		Cable quick connect connector	M8	25	P8CS0803J
	Cable quick connect connector		M12 - A coding	25	P8CS1204J
		"Y" shape, thread to thread	M12 - 2 x M12 - A coding	25	P8CSY1212A

D

Multi-connection head module

P	S	M	L	2	1	A	P
----------	----------	----------	----------	----------	----------	----------	----------

Multi-wire connection		Ported design	Thread type
L2	Sub-D25 connector	1 Side ported	3/8" BSPP
		2 Bottom ported	3/8" BSPP
		5 Side ported	3/8" NPT
		6 Bottom ported	3/8" NPT

Sub-D25 connection

Up to 24 solenoids on standard Sub-D25 connector.

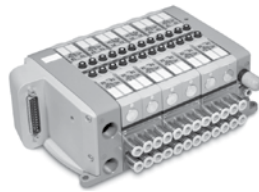

Technical data

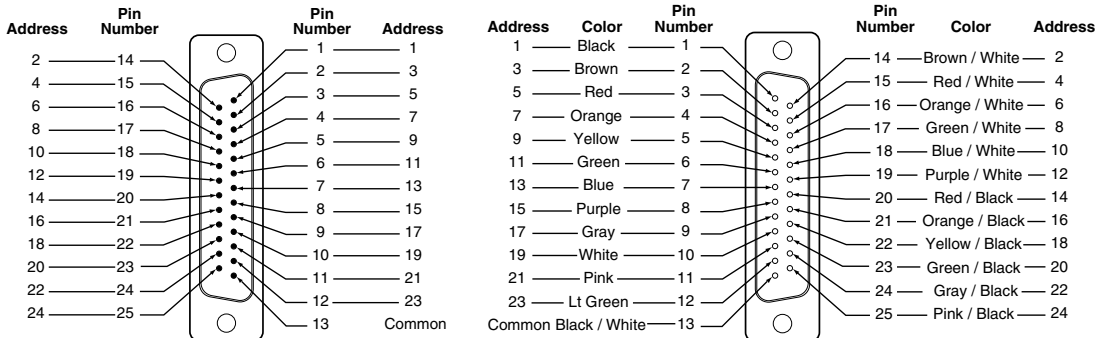
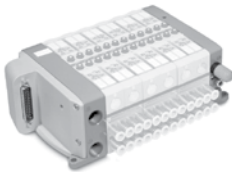

Rated voltage :	24 VDC
Maximum addresses :	24
Maximum energised simultaneously :	24
Electrical connection :	Sub-D25 pin DIN 41652, MIL-C-24308, NFC93425 type HE5
Polarity :	PNP and NPN compatible (solenoids not polarized)
Dust and water protection :	IP65 rated with properly assembled IP65 rated cable

Electrical multi-pole end modules

	Description	Sub-base design	Thread type	Weight (g)	Order code
	Sub-D25 ends module	Side ported	3/8" BSPP	250	PSML21AP
		Bottom ported	3/8" BSPP	250	PSML22AP

D

Electrical accessories

	Description	Cable length	Weight (g)	Order code
	Sub-D25 connector IP40 with flying leads multi-cable	3 m	380	P8LMH25M3A
		9 m	780	P8LMH25M9A
P8LMH25M3A	Sub-D25 connector IP65 with flying leads multi-cable	9 m	790	P8LMH25B9A

Centralized bus - Side ported

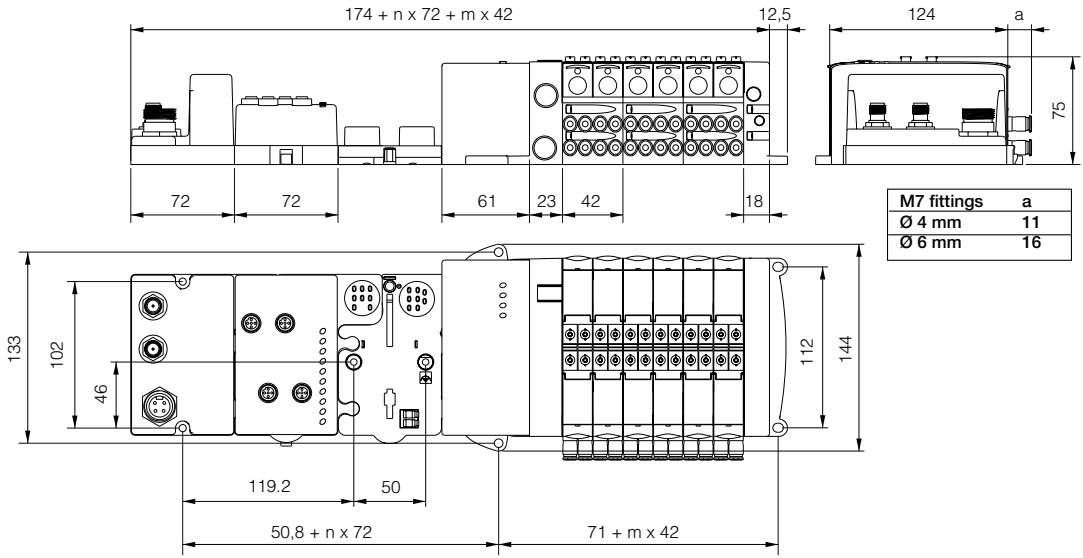

Centralized bus - Bottom ported

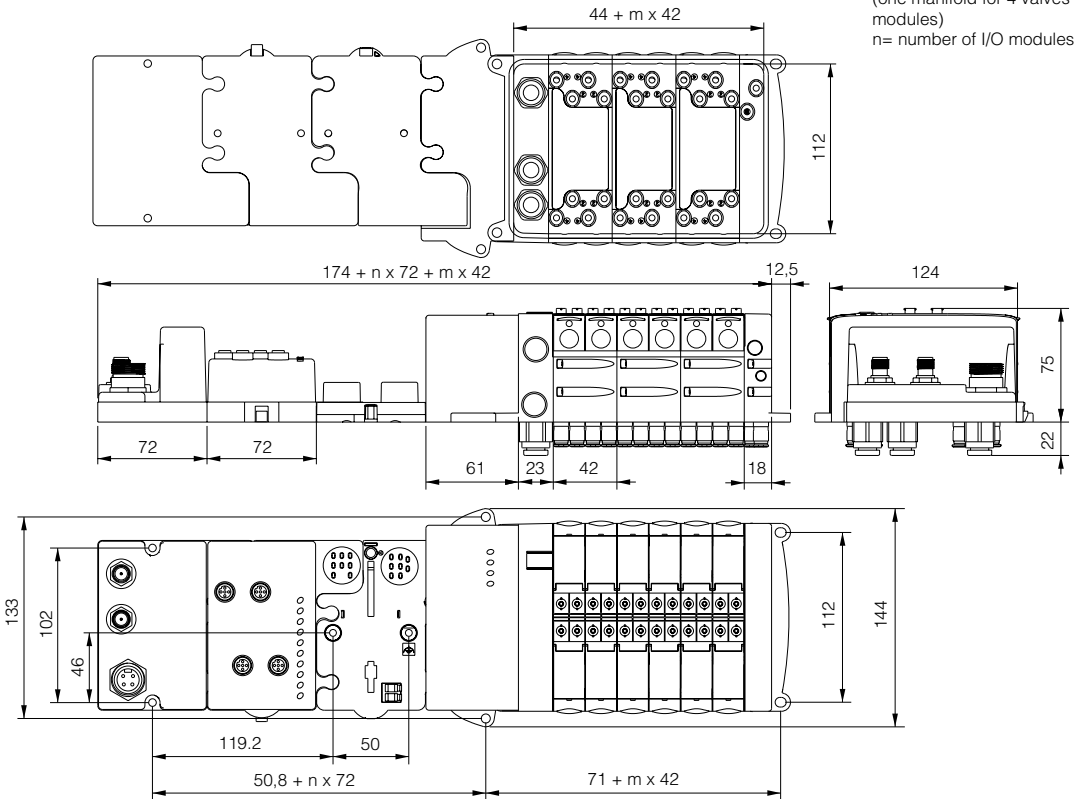

Note:
m = number of manifolds
(one manifold for 4 valves
modules)
n = number of I/O modules

Fieldbus - Side ported

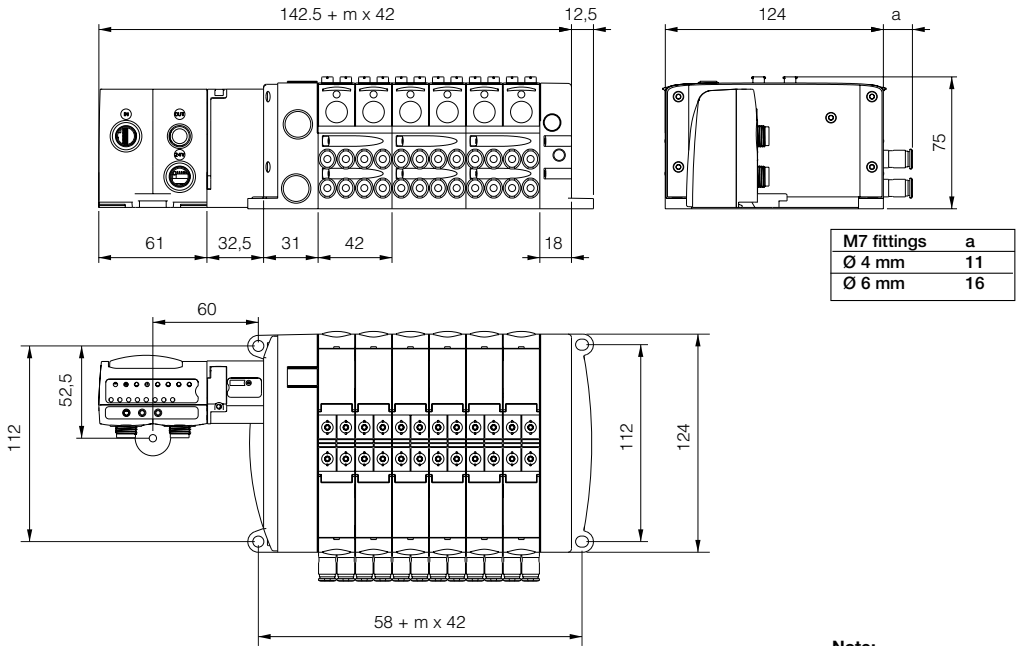

Note:
 m = number of manifolds
 (one manifold for 4 valves
 modules)

Fieldbus - Bottom ported

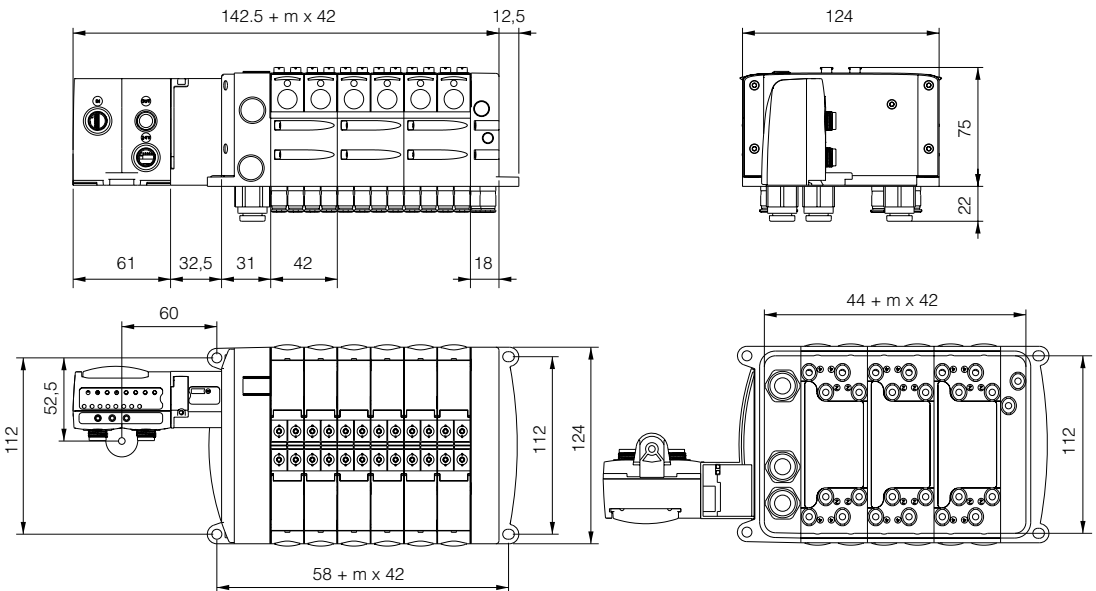

SubD25 - Side ported

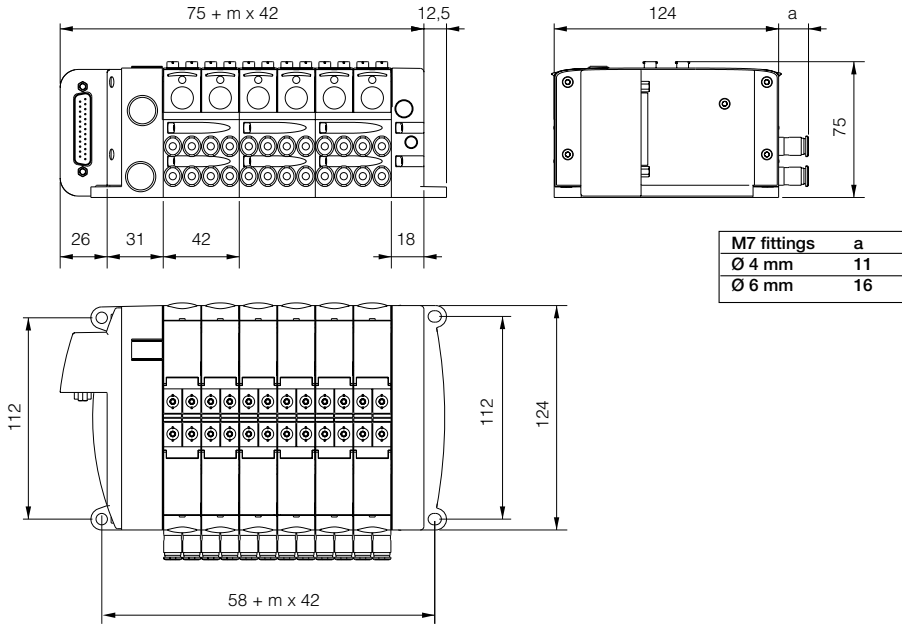

SubD25 - Bottom ported

Note:
m = number of manifolds
(one manifold for 4 valves
modules)

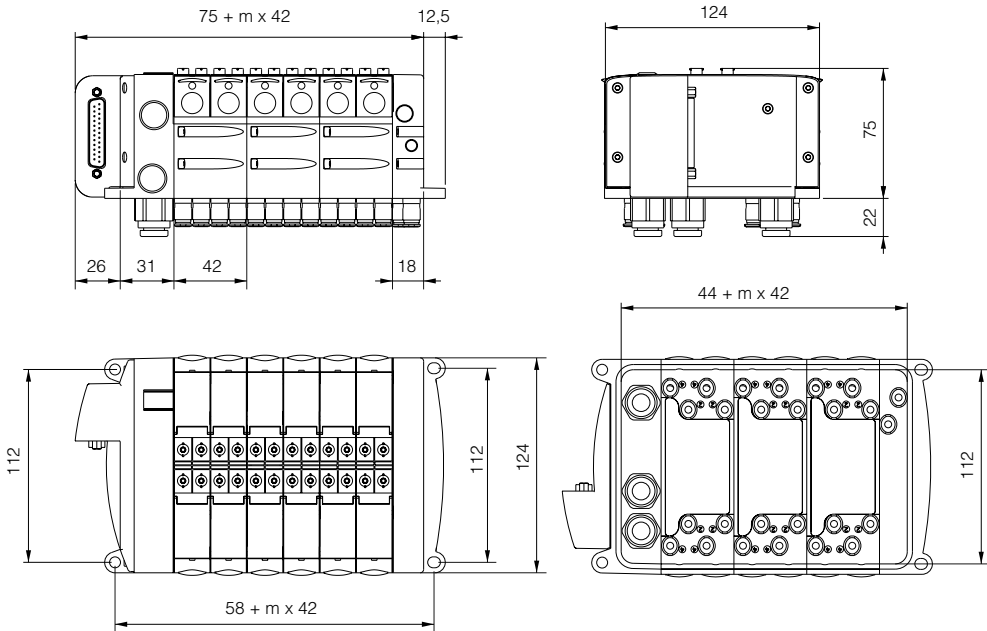

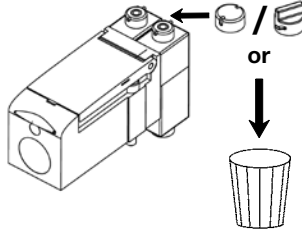

0,4 mN mini.
0,6 mN maxi.

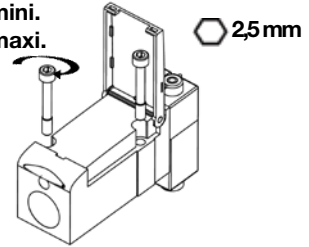

A

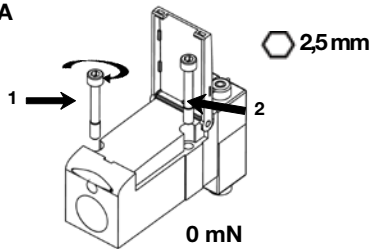

W930019620111

B

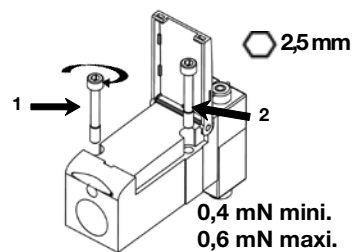

<http://www.parker.com/Pneumatic>

300196201W05 02



**Isys Micro
Installation & Service Instructions
Sheet B**

**ISSUED: 06 2008
Supersedes: None**

WARNING: Failure to follow all precautions, warnings, instructions, and information contained herein, and from the Parker website, may cause death, personal injury, and/or property damage. More detailed information, in several languages, may be obtained from the Parker website:

www.parker.com or call 1-800-C PARKER in the USA or 00 800 27 27 53 74 in Europe.

W930019620111

GENERAL SAFETY GUIDELINES

- Always disconnect the electric and air supply to the valve before adjusting.
- Always lockout power to machinery that the valve is attached to before adjusting.
- Keep hands and clothing away from any pinch points & paths of moving cylinders.
- Never disassemble valves without proper instruction and manuals. This may be obtained from a distributor or the website described above.

GENERAL INSTALLATION GUIDELINES

- Push plug-in pneumatic connectors securely into the modules and assemble the valve islands as shown on reverse side.
- Secure the valve or valve island using the din-rail fasteners or the mounting holes.
- Attach Parker tubing to the pneumatic connectors. Completely push clean, square-cut precision tubing into the pneumatic connectors.
- Attach electrical connections with power off.
- Test the system operation for function and leakage. Do not put into operation until the function is as intended and there is no leakage.

<http://www.parker.com/Pneumatic>

300196201W05 02



PSM . . AP

D

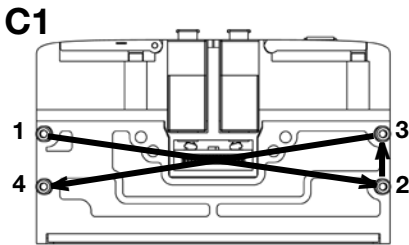
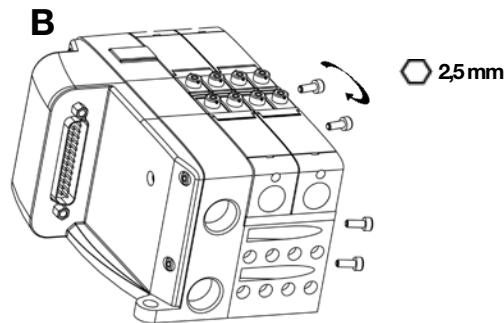
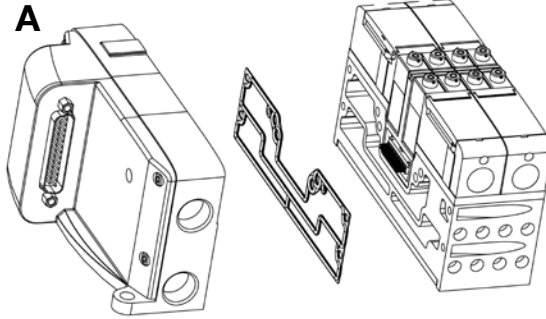

1, 2, 3, → 4 ↻ 0 mN

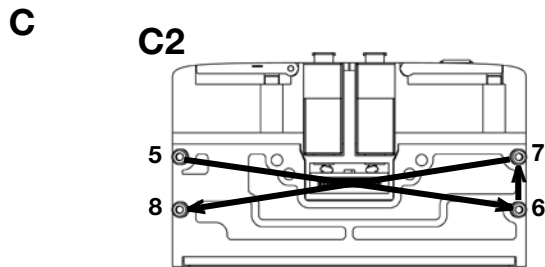

5, 6, 7, → 8 ↻ 0,5 mN mini.
0,8 mN maxi.

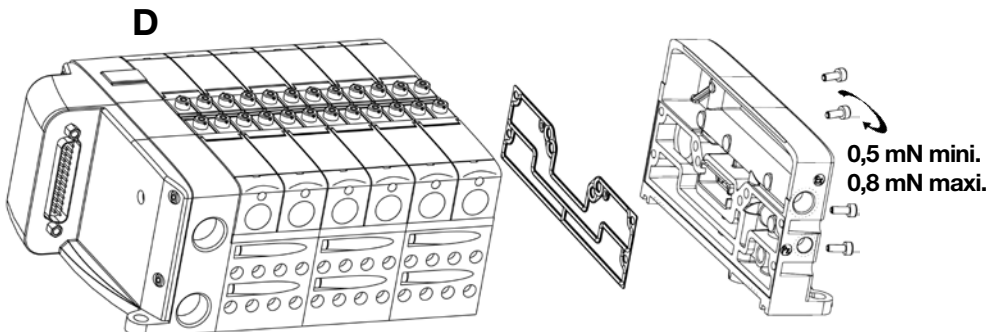

W930019630111

<http://www.parker.com/Pneumatic>

300196301W05 02





Inter-manifold seal plate

D

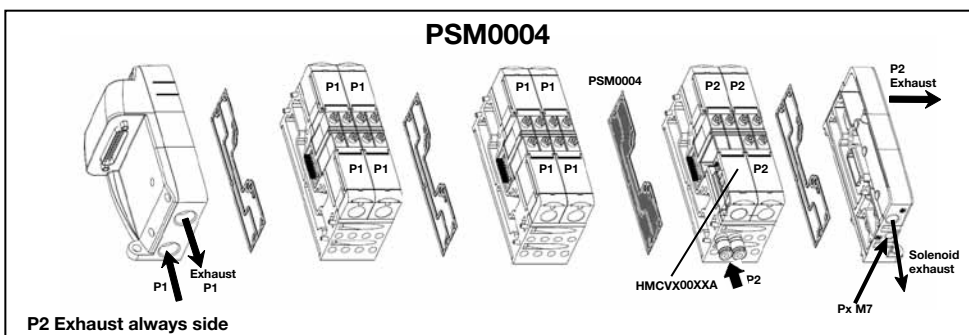
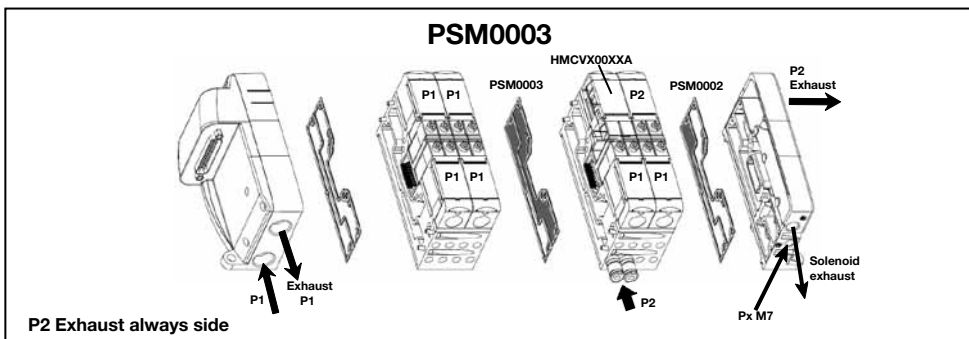
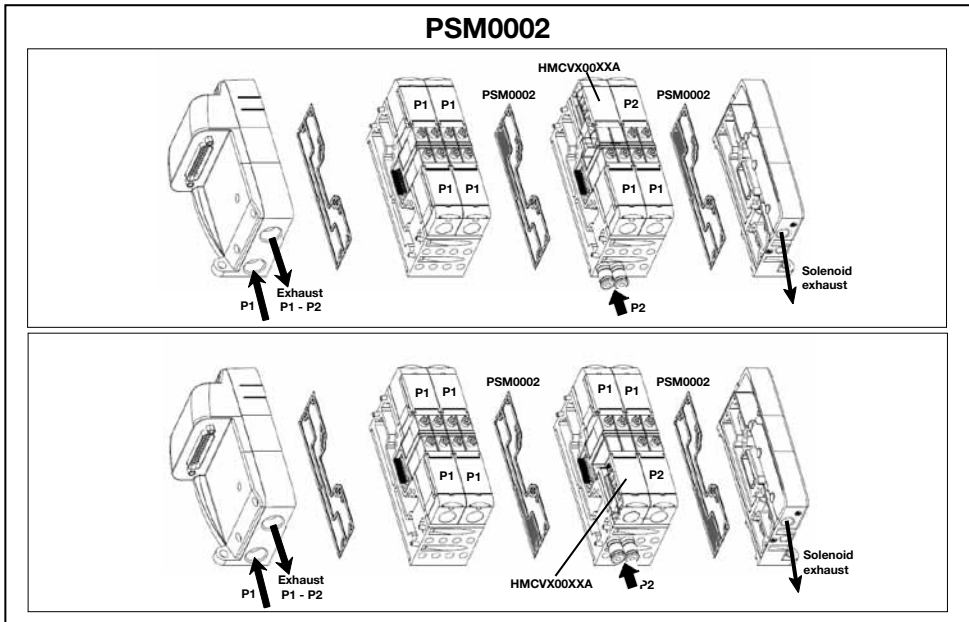

Operating pressure -0.9 to 8.3 bar, with external pilot pressure 6 bar. Solenoid pressure supply 2.7 to 8.3 bar

W930030350111

<http://www.parker.com/Pneumatic>

300303501W05 01





PSM...AP

Side ported

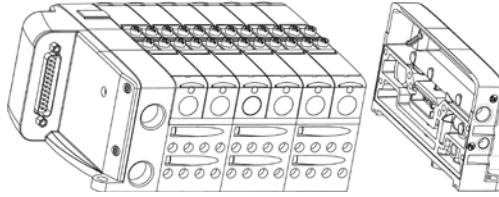

Internal solenoids pilot supply

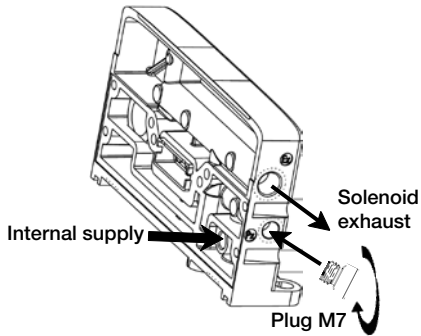

External solenoids pilot supply

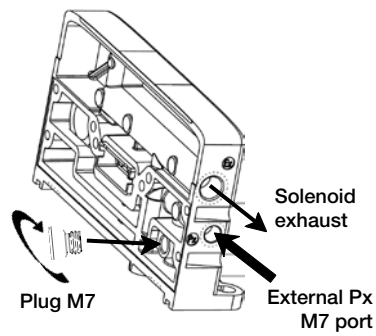

Bottom ported

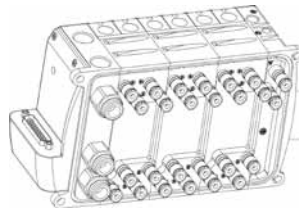

Internal solenoids pilot supply

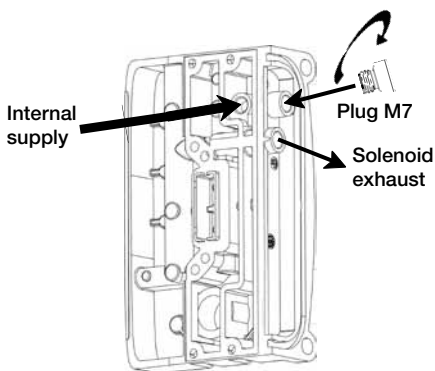

External solenoids pilot supply

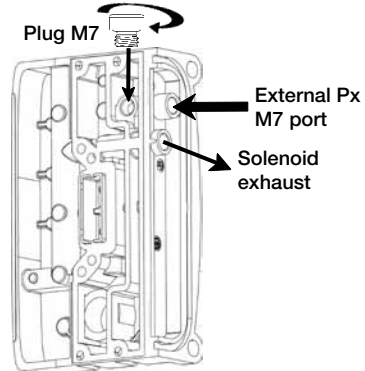

Operating pressure -0.9 to 8.3 bar, with external pilot pressure 6 bar. Solenoid pressure supply 2.7 to 8.3 bar

W930030340112

<http://www.parker.com/Pneumatic>

300303401W05 02





**ISYS-Micro
Installation & Service Instructions
Sheet B**

Supersedes: None

⚠️ Avertissement: Le non-respect des précautions, mises en garde, instructions et informations décrites dans le présent document ou sur le site Parker peut provoquer des dommages matériels et des blessures graves même mortelles. Des précautions complémentaires en plusieurs langues peuvent être obtenues en visitant le site Web Parker: www.parker.com ou appeler le 00 800 27 27 53 74 en Europe.

CONSIGNES GENERALES DE SECURITE

- Débrancher toujours les alimentations électrique et pneumatique du distributeur avant réglage.
- Couper toujours l'énergie de l'équipement avant réglage.
- Garder les mains et les vêtements hors de portée des points de pincement des pièces en mouvement.
- Ne jamais démonter les distributeurs sans les instructions ou manuels appropriés. Ces derniers peuvent être obtenus chez nos distributeurs ou sur le site web.

CONSIGNES GENERALES D'INSTALLATION

- S'assurer du bon positionnement des connecteurs pneumatiques dans leur logement.
- Fixer l'ilot sur un bâti à l'aide des logements.
- Utiliser des tubes Parker. Ils doivent être propres, coupés droits, sans résidu, et enfoncés complètement.
- Connecter électriquement les distributeurs ou ilots hors tension.
- Tester les fonctions et fuites du système. Ne jamais mettre en service sans s'assurer préalablement du bon fonctionnement et de l'absence de fuites.

⚠️ ACHTUNG: Nichtbeachten der hier und auf der Parker Website aufgeführten Vorsichtsmaßnahmen, Hinweise, Anleitungen und Informationen kann zu Tod, Personenschäden und/oder Zerstörung der Einrichtungen führen. Genauere Informationen in verschiedenen Sprachen können von der Parker Website: www.parker.com abgerufen werden. T: 00 800 27 27 53 74.

Allgemeine Sicherheitsrichtlinien

- Vor jeglicher Einstellarbeit an den Ventilen bzw. der Ventilsels sind die Druckluftleitungen zu trennen.
- Vor jeglicher Einstellarbeit an den Ventilen bzw. der Ventilsels ist der entsprechende Anlagenteil energie- und spannungslos zu machen.
- Halten Sie Abstand mit Händen und Kleidung von Klemmstellen (z.B. von Zylindern).
- Bauen Sie niemals Komponenten auseinander ohne entsprechend geeignete Anleitungen. Sie können diese erhalten von unseren Fachhändlern, eigenen Niederlassungen oder von der Webseite abrufen.

Allgemeine Installationsrichtlinien

- Drücken Sie die Einsteck-Schnellverbinder fest und sicher in die Basismodule wie gezeigt.
- Sichern Sie die Ventilsels durch Befestigungsschrauben an auf einer Montagefläche.
- Benutzen Sie nur Parker Kunststoffrohr in Verbindung mit den Schnellsteckverbindern.
- Das Rohr muss sauber, richtig abgeschnitten, ohne lose Partikel und komplett in die Verbinder gesteckt sein.
- Stellen Sie die elektrische Verbindung in spannungslosem Zustand her.
- Testen Sie das System auf Funktion und Leckagen. Nehmen Sie das System erst in Betrieb wenn die Funktionen wie geplant ablaufen und keine Leckagen vorhanden sind.

⚠️ WARNING: Failure to follow all precautions, warnings, instructions, and information contained herein, and from the Parker website, may cause death, personal injury, and/or property damage. More detailed information, in several languages, may be obtained from the Parker website: www.parker.com or call 1-800-C PARKER in the USA or 00 800 27 27 53 74 in Europe.

GENERAL SAFETY GUIDELINES

- Always disconnect the electric and air supply to the valve before adjusting.
- Always lockout power to machinery that the valve is attached to before adjusting.
- Keep hands and clothing away from any pinch points & paths of moving cylinders.
- Never disassemble valves without proper instruction and manuals. This may be obtained from a distributor or the website described above.

GENERAL INSTALLATION GUIDELINES

- Push plug-in pneumatic connectors securely into the modules and assemble the valve islands as shown on reverse side.
- Secure the valve or valve island using the din-rail fasteners or the mounting holes.
- Attach Parker tubing to the pneumatic connectors. Completely push clean, square-cut precision tubing into the pneumatic connectors.
- Attach electrical connections with power off.
- Test the system operation for function and leakage. Do not put into operation until the function is as intended and there is no leakage.

⚠️ ADVERTENCIA: O não cumprimento de todas as advertências, instruções e informações contidas nesta, pode causar morte, danos pessoais e/ou danos materiais. Maiores detalhes, em outras linguas, podem ser obtidos do website Parker: www.parker.com. T: 00 800 27 27 53 74 (Europe).

INSTRUCOES GERAIS PARA SEGURANCA

- Sempre desconecte a eletricidade e suprimento de ar da válvula antes da regulagem ou instalação das unidades.
- Sempre desconecte a válvula de qualquer máquina/equipamento antes da regulagem ou instalação.
- Mantenha as mãos e vestuário longe de pontos onde há riscos de agarrentos ou movimentos de cilindros para evitar acidentes.
- Nunca desmonte as válvulas sem manuais e instruções apropriadas. Estes podem ser obtidos da fábrica ou do website descrito anteriormente.

INSTRUCOES GERAIS PARA INSTALACAO

- Pressione os conectores especiais dentro das unidades de válvulas como mostrado
- Instale o conjunto do manifold na superfície utilizando parafusos nos furos de montagem.
- Conecte somente tubos Parker. Estes devem estar limpos, com corte das extremidade no esquadro, sem partículas soltas, e pressionadas completamente dentro das conexões.
- Faça as conexões elétricas com a linha desenergizada.
- Teste o sistema para checar o funcionamento e vazamentos. Não coloque o sistema em operação antes de checar se o funcionamento está adequado e não há vazamentos.

⚠️ WAARSCHUWING: Verzuimen tot het volgen van alle voorzorgsmaatregelen, en informaties zoals hier samengevat en op de Parker website, kan persoonlijk letsel, eigendomschade, of zelfs de dood tot gevolg hebben. Meer detail informatie, zie www.parker.com. T: 00 800 27 27 53 74 (Europe).

Algemene veiligheidsrichtlijnen

- Altijd de lucht- en stroomtoevoer naar het ventiel afsluiten voor men gaat afstellen.
- Altijd de energie naar de machine waar het ventiel op gemonteerd zit afsluiten voor men gaat afstellen.
- Handen en kleding weghouden van de klempunten en bewegende cilinders.
- Nooit ventielen demonteren zonder de juiste instructie en handleidingen.

Algemene installatie voorschrift

- Bevestig speciale koppelingen precies zoals hierboven wordt getoond.
- Bevestig de ventielunit op ondergrond door schroeven te plaatsen.
- Allen Parker leidingen in de koppelingen bevestigen. Deze moeten schoon en recht afgesneden zijn, zodat ze goed in de koppeling passen.
- Elektrische aansluitingen plaatsen, alleen als de voeding uit staat.
- System testen op werking en lekkage, en niet in gebruik nemen voordat aan beide eisen voldaan is.

⚠️ PRECAUCION: La Negligencia a los avisos de precaución, instrucciones e información contenida aquí y en el sitio Web de Parker pueden causar la muerte, daños personales y/o daño a la propiedad. Mas información detallada en diferentes idiomas pueden ser obtenidos del sitio Web de Parker: www.parker.com o llamando al teléfono 1-800-C PARKER en los Estados Unidos de América o 00 800 27 27 53 74 en Europa.

NORMAS GENERALES DE SEGURIDAD.

- Siempre desconecte el suministro de energía eléctrica y aire comprimido a la válvula antes de ajustar o instalar unidades.
- Siempre baje el interruptor de energía eléctrica de la maquinaria en la que la válvula esta instalada antes de ajustarla.
- Mantenga las manos y ropa fuera de cualquier punto apriete o partes móviles de los cilindros.
- Nunca desensamble válvulas sin los manuales o instrucciones adecuadas. Estos pueden ser obtenidos de un distribuidor o del sitio Web descrito arriba.

NORMAS GENERALES DE INTALACION

- Presione los conectores especiales asegurándose contra las bases como se muestra.
- Asegure el ensamble de manifold a la superficie usando conectores rápidos.
- Conecte solamente tubing Parker a las conexiones. Estos deberán de estar limpios, cortados en escuadra, sin partículas sueltas, y presionados completamente dentro de las conexiones.
- Realice las conexiones eléctricas con el interruptor de energía en apagado (OFF).
- Pruebe la operación del sistema verificando funcionamiento y fugas. No lo ponga en operación hasta que cumpla con la operación requerida y que no haya fugas.

⚠️ WARNING: Instruktioner, varningar och information i denna handling, och på Parkers website, skall följas noggrant. Följden av att bortska från dessa kan medföra dödsfall, personskador och/eller skador på egendom. Detaljerad information, på flera språk kan hämtas från Parkers website www.parker.com eller ring 00 800 27 27 53 74 (Europe).

GENERELLA SÄKERHETSANVISNINGAR

- Stäng alltid av både el och luftförsörjningen innan justeringar på ventilen genomförs.
- Bryt alltid huvudströmmen till maskinen som ventilen betjänar.
- Se till att hålla undan händer och kläder från klämrisken.
- Plocka aldrig isär en ventil utan att ha först hämtat underlag för detta från webbsidan eller leverantören.

GENERELLA INSTALLATIONSANVISNINGAR

- Tryck de speciella anslutningarna ordentligt fast i underdelen, se bilden.
- Sätt fast ventils bas ordentligt på ett stabilt underlag.
- Montera enbart Parker slang i instickskopplingarna. Dessa måste skäras av rakt och vara utan s.k.skägg eller lösa partiklar samt tryckas helt in i kopplingen.
- Koppla in elen med huvudbrytaren i frågan.
- Test systemet sedan för funktion och läckage. Starta ej maskin förän fullgod funktion och värtet uppnått.

⚠️ ATTENZIONE! Il mancato rispetto delle precauzioni, avvertenze, istruzioni, ed informazioni contenute di seguito e nel sito web Parker, può provocare danni a cose o persone, anche con conseguenze letali. Per informazioni più dettagliate nelle varie lingue, consultate sito web Parker: www.parker.com o, negli Stati Uniti, chiamare il 00 800 27 27 53 74 (Europe).

ISTRUZIONI DI SICUREZZA

- Scollegare sempre la valvola dall'alimentazione elettrica e pneumatica prima di regolare le periferiche.
- Interrompere sempre l'alimentazione elettrica ai macchinari cui la valvola è collegata prima di procedere alla regolazione.
- Tenere le mani e gli abiti lontani dai cilindri in movimento in modo che non rimangano impigliati o intrappolate.
- Non smontare mai le valvole senza aver prima seguito scrupolosamente i manuali di istruzioni che si possono richiedere al distributore, o scaricare dal sito web sopra citato.

ISTRUZIONI GENERALI D'INSTALLAZIONE

- Inserire e fissare i raccordi speciali nelle basi come indicato nel disegno.
- Fissare il manifold ad un piano mediante i dispositivi di fissaggio indicati.
- Collegare ai raccordi esclusivamente tubi Parker. I tubi devono essere puliti con le estremità tagliate a squadra, senza parti libere e inseriti nel raccordo fino in fondo.
- Attaccare le connessioni elettriche ad apparecchio spento.
- Collaudare il sistema per controllarne il funzionamento ed individuare eventuali perdite. Non utilizzare finché il funzionamento non risulta corretto e senza perdite.



D



ISO Valves for the Rail Industry

ISO 5599-1, Sizes 1, 2 and 3

Control Devices

The Isomax Railway range of directional control valves, ISO5599-1

ISO 5599 - 1



DX1 1/4", size 1,

DX2 3/8", size 2,

DX3 1/2", size 3,

includes both 5/2 and 5/3 valves, for pneumatic and electrical actuation with a wide choice of subbases and manifolds to suit different application needs in the Railway market.



E



Parker's many years of experience in designing pneumatic products and systems for the rail industry has produced a depth of 'industry specific' knowledge unrivalled in the market place, with a wealth of products, both standard and custom built ideally suited to a wide range of applications.

Throughout Europe Parker have a team of Application Engineers and Design and System Engineers who work closely with customers to understand their requirements and to ensure the optimum engineering solution is provided.

The principal application areas that ISOMAX Railway have experience in include :

Door Step Control

Trip Cock Reset Valves

Coupling Systems

Horn

Sanding Control Systems

Whistle

Pantograph Operation

Internal and External Door Actuation and Control

Parking Brake



ISO Specifications

Common for Railway



5599-1



External electrical connection subbase valves

The ISO Standard 5599-1 specifies an interface pattern for a common subbase valve consisting of pressure passages 1, 3, 5, 2 & 4 and pilot passages 12 & 14. The width of the pattern and location of the 4 bolt holes are also specified. There are no specifications for the type of external electrical connection used to control the valve.

Size : 1 2 3

E

Other specifications not used for Railway
(for information)



5599-2

Body-to-base plug-in subbase valves

Same as 5599-1 for pneumatic pressure passages, 5599-2 standard also specifies a plug-in electrical connection.

Sizes : 1 2 3



15407-1

(VDMA 24563)

External electrical connection subbase valves

The ISO Standard 15407-1 specifies an interface pattern for a common subbase valve consisting of pressure passages 1, 3, 5, 2 & 4 and pilot passages 12 & 14. The width of the pattern and location of the 4 bolt holes are also specified. There are no specifications for the type of external electrical connection used to control the valve.

Size : 02 01



15407-2

Body-to-base plug-in subbase valves

Same as 15407-1 for pneumatic pressure passages, 15407-2 standard also specifies a plug-in electrical connection.

Size : 01 02

ISO Specifications

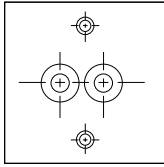

CNOMO 06-05-01

The solenoid pilot interface often used with ISO 5599-1 valves is the CNOMO interface. The CNOMO interface specifies the pressure and actuator port, and the screw holes for the mounting of this solenoid pilot. It is commonly used in European automotive plants, and its usage is becoming more prevalent for industrial ISO 5599-1 valves.

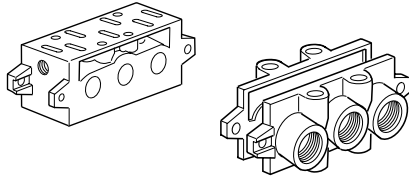

VDMA 24345

The VDMA 24345 is a standard for Manifolds and Subbase specifying a common base mounting footprint in addition to ISO 5599-1 Interface standard. (VDMA is a German organisation - Verband Deutscher Maschinen und Anlagen-Bauer - which is translated to Federation of German Machine and Unit Builders.)

Choice of components for air supply to cylinders

In the chart below can you find the suitable valves, tubes etc. for each cylinder size. If you have a tube length over 2 m, choose one tube size larger than in the chart.

Following data is valid :
 Supply pressure : min 7,0 bar
 Regulator pressure setting : 6,0 bar
 Pipe length between air treatment unit and valve : max 1 m
 Pipe length between valve and cylinder : max 2 m

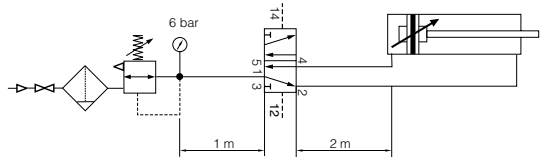

Cylinder bore	<Ø20	Ø20-32	Ø40-50	Ø63	Ø80	Ø100	Ø125	Ø160	Ø200
Cylinder port	M5	G1/8	G1/4	G3/8	G3/8	G1/2	G1/2	G3/4	G3/4
Tubing Ext / Int	4 / 2.7	6 / 4	8 / 6	10 / 7	10 / 7 12 / 9	12 / 9 14 / 11	14 / 11	18 / 15	20 / 18
Size 1 Isomax	G1/4	G1/4	G1/4	G1/4	G1/4	G1/4			
Size 2 Isomax			G3/8	G3/8	G3/8	G3/8	G3/8		
Size 3 Isomax				G1/2	G1/2	G1/2	G1/2	G1/2	G1/2

Cylinder speed < 0.5 m/s
 Cylinder speed < 1 m/s
 Cylinder speed > 1 m/s

• **Rust and Corrosion resistance Design :**

- **Metal body.**
- **Thick anodised aluminium casting.**
- **Stainless steel screws and armature.**

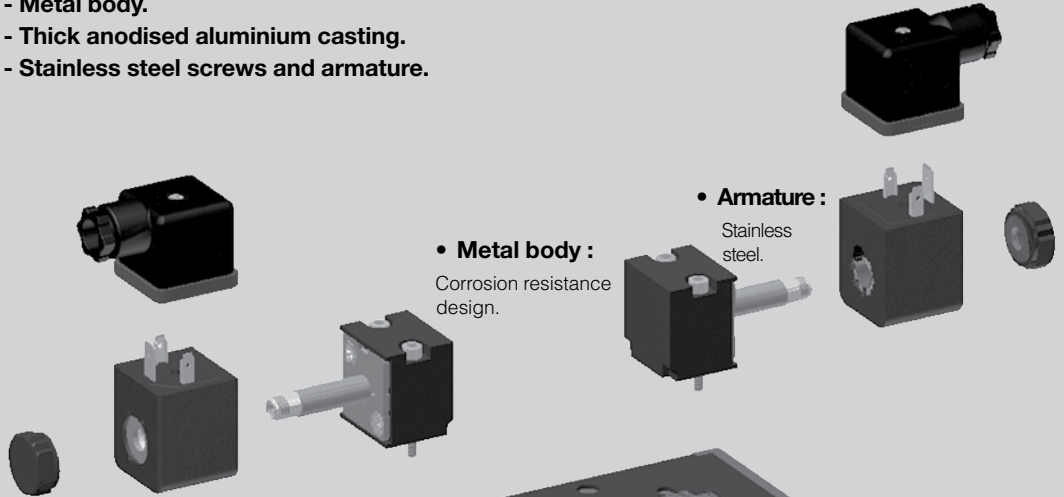

• **Metal body :**
Corrosion resistance design.

• **Armature :**
Stainless steel.

• **Coil :**

- IP 65 , thermoplastic.
- + / - 30 % Voltage tolerance.
- DC range (12 to 110 V DC).

• **Operating temperature :**

- 30 °C + 60 °C.

• **Shock and Vibration :**

IEC 61373 : 1999
Cat 1

• **Ceramic technology**

- **Stable long lasting performances :**

Low friction switching : minimum wear of the valve member/ seal assembly.

- **Excellent reliability :**

Long life in excess of 100 million operation, subject to the air supply being filtered to ISO 8573-1 standard.

- **High performances :**

Slide valve concept allows high flow / size ratio and short response time due to short slide stroke and low friction.

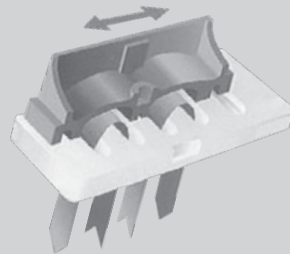

E

Material Specification and Characteristics

Isomax Railway Valve

Material

Valve member - seat :	Self lubricating acetal - ceramic
Body :	Polyamide reinforced fibreglass
Casing - End plates :	Anodised aluminium
Valve plate :	Zamak
Seals :	Nitrile
Springs :	Stainless steel
Screws :	Stainless steel

Railway Solenoid

Pilot Valve

Body :	Aluminium
Armature tube :	Stainless steel
Plunger & core :	Corrosion resistant Cr-Ni steel
Seals :	Low temp FKM
Screws :	Stainless steel

Railway

Coil

Encapsulation material :	Thermoplastic as standard
--------------------------	---------------------------

Characteristics

Fluid :	Air or inert gas filtered 40 µ class 5 according to ISO 8573-1 dry class according to service temperature non-lubricated, or lubricated
Storage temperature :	-40 °C to + 70 °C
Low temperature climatic :	According to EN 60068-2-1, test Ad
High temperature climatic :	According to EN 60068-2-2, test Bd
Shock and Vibration :	According to IEC 61373 : 1999 Cat 1 Class B
Salt spray test :	According to ISO 9227, 168 h
Solenoid orifice :	1.2/1.3mm
Power (DC) :	6 to 6.8W
Voltage tolerance :	+/- 30%
Pull in voltage :	According to VDE 0580 July 2000
Duty cycle :	100%
Insulation :	Class II 2000 V
Temperature :	Class F 155 °C
Electrical connection :	Din A

Certification

EMC / CE mark :	According to EN 61 000-6-2
Dust & water protection :	IP65 according to EN 60529

Transients

Interrupting the current through the solenoid coil produces momentary voltage peaks which, under unfavourable conditions, can amount to several hundred times the rated operating voltage. Normally, these transients do not cause problems, but to achieve the maximum life of relays in the circuit (and particularly of transistors, thyristors and integrated circuits) it is desirable to provide protection by means of voltage-dependent resistors (varistors). All connectors/cable plugs EN175301-803 with LED's include this type of circuit protection.

Isomax - ISO 5599 - Size 1 / 2 / 3 - CNOMO

Order chart

DX	1	- R	06	- A	N	
-----------	----------	------------	-----------	------------	----------	--

Size	
1	Size 1 (ISO 5599)
2	Size 2 (ISO 5599)
3	Size 3 (ISO 5599)

Voltage	
DC	
47	12
48	24
74	48
70	72
71	96
72	110
Blank	Valve less coil

Valve type function	
Internal pilot supply	
06	5/2 double solenoid
56	5/2 double solenoid, 14 prioritised
21	5/2 single solenoid, spring return
51	5/2 single solenoid, differential return
11	5/3 double solenoid vented centre
16	5/3 double solenoid closed centre
13	5/3 double solenoid pressurised centre
External pilot 14 supply	
05	5/2 double solenoid
59	5/2 double solenoid, 14 prioritised
23	5/2 single solenoid, spring return
54	5/2 single solenoid, differential return
09	5/3 double solenoid vented centre
19	5/3 double solenoid closed centre
14	5/3 double solenoid pressurised centre

Solenoid enclosure	
L	3 pin 30mm DIN 43650A
N	Valve less coil

Electrical version - manual override	
A	No override
B	Non-locking Flush - Metal
C	Locking Flush - Metal
D	Non-locking Extended - Metal
Pneumatic version	
60	No override

Railway Version	

Part numbers for complete valves available on request.
 Shaded part numbers are standard.

Isomax



E

Material Specification and Characteristics**Isomax Railway Valve****Material**

Valve member - seat :	Self lubricating acetal - ceramic
Body :	Polyamide reinforced fibreglass
Casing - End plates :	Anodised aluminium
Valve plate :	Zamak
Seals :	Nitrile
Springs :	Stainless steel
Screws :	Stainless steel

Railway Solenoid**Pilot Valve**

Body :	Aluminium
Armature tube :	Stainless steel
Plunger & core :	Corrosion resistant Cr-Ni steel
Seals :	Low temp FKM
Screws :	Stainless steel

Railway**Coil**

Encapsulation material :	Thermoplastic as standard
--------------------------	---------------------------

Characteristics

Fluid :	Air or inert gas filtered 40 µ class 5 according to ISO 8573-1 dry class according to service temperature non-lubricated, or lubricated
Storage temperature :	-40 °C to + 70 °C
Low temperature climatic :	According to EN 60068-2-1, test Ad
High temperature climatic :	According to EN 60068-2-2, test Bd
Shock and Vibration :	According to IEC 61373 : 1999 Cat 1 Class B
Salt spray test :	According to ISO 9227, 168 h
Solenoid orifice :	1.2/1.3mm
Power (DC) :	6 to 6.8W
Voltage tolerance :	+/- 30%
Pull in voltage :	According to VDE 0580 July 2000
Duty cycle :	100%
Insulation :	Class II 2000 V
Temperature :	Class F 155 °C
Electrical connection :	Din A

Certification

EMC / CE mark :	According to EN 61 000-6-2
Dust & water protection :	IP65 according to EN 60529

Transients

Interrupting the current through the solenoid coil produces momentary voltage peaks which, under unfavourable conditions, can amount to several hundred times the rated operating voltage. Normally, these transients do not cause problems, but to achieve the maximum life of relays in the circuit (and particularly of transistors, thyristors and integrated circuits) it is desirable to provide protection by means of voltage-dependent resistors (varistors). All connectors/cable plugs EN175301-803 with LED's include this type of circuit protection.

Isomax - ISO 5599 - Size 1 / 2 / 3 - CNOMO

Order chart

DX

1

-

R

06

-

A

N

Size	
1	Size 1 (ISO 5599)
2	Size 2 (ISO 5599)
3	Size 3 (ISO 5599)

Railway Version

Voltage	
DC	
47	12
48	24
74	48
70	72
71	96
72	110
Blank	Valve less coil

Valve type function	
Internal pilot supply	
06	5/2 double solenoid
56	5/2 double solenoid, 14 prioritised
21	5/2 single solenoid, spring return
51	5/2 single solenoid, differential return
11	5/3 double solenoid vented centre
16	5/3 double solenoid closed centre
13	5/3 double solenoid pressurised centre
External pilot 14 supply	
05	5/2 double solenoid
59	5/2 double solenoid, 14 prioritised
23	5/2 single solenoid, spring return
54	5/2 single solenoid, differential return
09	5/3 double solenoid vented centre
19	5/3 double solenoid closed centre
14	5/3 double solenoid pressurised centre

Solenoid enclosure	
L	3 pin 30mm DIN 43650A
N	Valve less coil

Electrical version - manual override	
A	No override
B	Non-locking Flush - Metal
C	Locking Flush - Metal
D	Non-locking Extended - Metal
Pneumatic version	
60	No override

Part numbers for complete valves available on request.
 Shaded part numbers are standard.

E

Control Devices

Solenoid operated ISO Railway Valve fitted with CNOMO operator without coil

Solenoid plug/connector to be ordered separately. See page 14.

Symbol	Size	Actuation	Return	Changeover time (ms) at 6 bar 20 °C actua./return	Weight kg	Order code
5/2 Valves						
	1 - 43 mm	Electrical signal	Spring	40/55	0.400	DX1-R21-AN
	2 - 56 mm	Electrical signal	Spring	60/105	0.650	DX2-R21-AN
	3 - 71 mm	Electrical signal	Spring	85/160	1.150	DX3-R21-AN
	1 - 43 mm	Electrical signal	Differential	30/70	0.400	DX1-R51-AN
	2 - 56 mm	Electrical signal	Differential	55/110	0.650	DX2-R51-AN
	3 - 71 mm	Electrical signal	Differential	80/180	1.150	DX3-R51-AN
	1 - 43 mm	Electrical signal	Electrical signal	25/25	0.550	DX1-R06-AN
	2 - 56 mm	Electrical signal	Electrical signal	30/30	0.800	DX2-R06-AN
	3 - 71 mm	Electrical signal	Electrical signal	40/40	1.300	DX3-R06-AN
5/3 Valves						
	1 - 43 mm	Electrical signal	Electrical signal	30/95	0.550	DX1-R16-AN
	2 - 56 mm	Closed centre	Self centering	40/190	0.800	DX2-R16-AN
	3 - 71 mm			55/330	1.300	DX3-R16-AN
	1 - 43 mm	Electrical signal	Electrical signal	25/70	0.550	DX1-R11-AN
	2 - 56 mm	Vented centre	Self centering	40/140	0.800	DX2-R11-AN
	3 - 71 mm			60/270	1.300	DX3-R11-AN
	1 - 43 mm	Electrical signal	Electrical signal	25/65	0.550	DX1-R13-AN
	2 - 56 mm	Press. centre	Self centering	40/150	0.800	DX2-R13-AN

Indicates stocked products.

Pneumatic operated ISO Railway Valve without valve spool override



Symbol	Size	Actuation	Return	Changeover time (ms) at 6 bar 20 °C actua./return	Weight kg	Order code
5/2 Valves						
	1 - 43 mm	Air signal	Spring	30/45	0.350	DX1-R21-60
	2 - 56 mm	Air signal	Spring	50/95	0.600	DX2-R21-60
	3 - 71 mm	Air signal	Spring	80/160	1.100	DX3-R21-60
	1 - 43 mm	Air signal	Differential	25/60	0.350	DX1-R51-60
	2 - 56 mm	Air signal	Differential	45/100	0.600	DX2-R51-60
	3 - 71 mm	Air signal	Differential	70/170	1.100	DX3-R51-60
	1 - 43 mm	Air signal	Air signal	20/20	0.350	DX1-R06-60
	2 - 56 mm	Air signal	Air signal	25/25	0.600	DX2-R06-60
	3 - 71 mm	Air signal	Air signal	35/35	1.100	DX3-R06-60
5/3 Valves						
	1 - 43 mm	Air signal	Air signal	20/80	0.350	DX1-R16-60
	2 - 56 mm	Closed centre	Self centering	30/170	0.600	DX2-R16-60
	3 - 71 mm			45/330	1.100	DX3-R16-60
	1 - 43 mm	Air signal	Air signal	20/65	0.350	DX1-R11-60
	2 - 56 mm	Vented centre	Self centering	30/140	0.600	DX2-R11-60
	3 - 71 mm			50/270	1.100	DX3-R11-60
	1 - 43 mm	Air signal	Air signal	20/60	0.350	DX1-R13-60
	2 - 56 mm	Press. centre	Self centering	25/140	0.600	DX2-R13-60

ISO 5599-1 Subbase & Manifolds

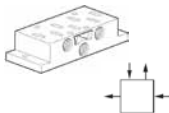
VDMA Side Ported Subbases

Description	Size	Port size	Weight kg	Order code
 <p>Subbases VDMA Side port according to VDMA Side port according to VDMA Side port according to VDMA</p>	1 - 43 mm	G1/4	0.160	P2N-VS512SD
	2 - 56 mm	G3/8	0.280	P2N-WS513SD
	3 - 71 mm	G1/2	0.350	P2N-YS514SD

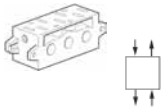
VDMA Bottom Ported Manifold

Description	Size	Port size	Weight kg	Order code
 <p>VDMA Form C Bottom port according to VDMA Bottom port according to VDMA Bottom port according to VDMA</p>	1 - 43 mm	G1/4	0.240	P2N-VM512MB
	2 - 56 mm	G3/8	0.360	P2N-WM513MB
	3 - 71 mm	G1/2	0.700	P2N-YM514MB
<p>VDMA Transition plate Size 1 to Size 3 Kit includes : Transition plate only</p>	1 to 3	G1/4		P2N-VM500AK
 <p>VDMA Form D - End plate According to VDMA According to VDMA According to VDMA</p>	1 - 43 mm	G3/8	0.210	P2N-VM513ES
	2 - 56 mm	G1/2	0.360	P2N-WM514ES
	3 - 71 mm	G1	0.680	P2N-YM518ES
<p>VDMA Isolation - Main galley According to VDMA According to VDMA According to VDMA Kit includes : (1) Isolator plug.</p>	1 - 43 mm			P2N-VK0P
	2 - 56 mm			P2N-WK0P
	3 - 71 mm			P2N-YK0P

Accessories

Description	Size	Port size	Weight kg	Order code
 <p>Blanking plate Kit includes : (1) Blanking plate, (1) Gasket and (4) Mounting bolts</p>	1 - 43 mm	G1/4	0.100	P2N-AA5B
	2 - 56 mm	G3/8	0.150	P2N-BA5B
	3 - 71 mm	G1/2	0.200	P2N-CA5B

 Indicates stocked products.

Control Devices









Side ported subbases

Description	Size	Port size	Weight kg	Order code BSP
 Single subbase 1 3 5 2 4 ports & 12 14	1 - 43 mm	G1/4	0.160	PL1-1/4-70
	1 - 43 mm	G3/8	0.160	PL1-3/8-70
	2 - 56 mm	G3/8	0.280	PL2-3/8-70
	2 - 56 mm	G1/2		P2N-HS514SS
	3 - 71 mm	G1/2		PL3-1/2-70
	3 - 71 mm	G3/4		P2N-JS516SD





Bottom ported subbases

Description	Size	Port size	Weight kg	Order code BSP
 Single subbase 1 3 5 2 4 ports & 12 14	1 - 43 mm	G1/4	0.370	PD1-1/4-70
	2 - 56 mm	G3/8	0.590	PD2-3/8-70
	3 - 71 mm	G1/2	0.590	PD3-1/2-70

Size 1 bottom ported manifold

Description	Size	Port size	Weight kg	Order code
  Manifold With bottom ports low profile	1 - 43 mm	G1/4	0.200	P2N-AM512MB
  Connecting block Top or bottom ported connecting block for above manifold "low profile"	1 - 43 mm	G3/8	0.150	P2N-AM513GT
  End End piece for above manifold "low profile"	1 - 43 mm	no	0.060	P2N-AM500J
  Intermediate supply Top or bottom ported intermediate supply for above manifold "low profile"	1 - 43 mm	G3/8	0.140	P2N-AM513BT
 Isolation plugs Isolating seal for above manifold "low profile"	1 - 43 mm		0.070	P2N-AK0P

Sizes 1 & 2 side ported manifold

Description	Size	Port size	Weight kg	Order code
  Manifold Manifold with side ports	1 - 43 mm	G1/4	0.240	P2N-EM512MD
	2 - 56 mm	G3/8	0.210	P2N-FM513MD
  End Side ported connecting kit for above manifold with side ports	1 - 43 mm	G3/8	0.360	P2N-EM513ES
	2 - 56 mm	G1/2	0.290	P2N-FM514ES

Indicates stocked products.

Solenoid coils with Din A 30 x 30 connection

Voltage	Order code	Weight (kg)
Direct current		
12V DC	P2FCA447	0.105
24V DC	P2FCA448	0.105
48V DC	P2FCA474	0.105
72V DC	P2FCA470	0.105
96V DC	P2FCA471	0.105
110V DC	P2FCA472	0.105

Spare Solenoid Nut

Diffuser plastic nut for vented exhaust

Order Code	Weight (kg)
P2FND	0.010

Spare Solenoid Operators

Solenoid pilot operator CNOMO NC

Description	Order code	Weight (kg)	Order code	Weight (kg)	Order code	Weight (kg)
	No manual override		Non-lock. manual override		Locking manual override	
Mobile metal	P2FP43M4A	0.100	P2FP43M4B	0.100	P2FP43M4C	0.100

Note.

Solenoid pilot operators are fitted to the Isomax Railway valve range. Order the above part numbers for spares. The operators are supplied with mounting screws and interface 'O' rings.

Coils and connectors must be ordered separately.

Solenoid Connectors / Cable Plugs 30 mm Form A ISO4400

	Description	Order code
With standard screw	Standard IP65 without flying lead	3EV290V10
	With LED and protection 24V AC/DC	3EV290V20-24
	With LED and protection 110V AC	3EV290V20-110
With cable	24V AC/DC, 5m cable LED and protection IP65	3EV290V20-24L5
	110V AC/DC, 5m cable LED and protection IP65	3EV290V20-110L5

Indicates stocked products.

Accessories

Silencers

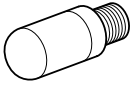

Port	Order code	Pack Qty
G1/8	P6M-PAB1	10
G1/4	P6M-PAB2	10
G3/8	P6M-PAB3	10
G1/2	P6M-PAB4	10

Fittings

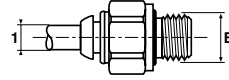

Male connector - BSPP

Tube dia 1	Thread B	Order code	Box Qty
4	1/8	F4PMB4-1/8	20
4	1/8	F4PMB4-1/8	20
6	1/8	F4PMB6-1/8	30
8	1/8	F4PB8-1/8	40
6	1/4	F4PMB6-1/4	30
8	1/4	F4PB8-1/4	30
10	1/4	F4PB10-1/4	20
12	1/4	F4PB12-1/4	10
8	3/8	F4PB8-3/8	20
10	3/8	F4PB10-3/8	20
12	3/8	F4PB12-3/8	10
14	3/8	F4PB14-3/8	10
10	1/2	F4PB10-1/2	10
12	1/2	F4PB12-1/2	10
14	1/2	F4PB14-1/2	10

Indicates stocked products.

Railway Isomax Valve - Dimensions (mm)

Pneumatically actuated

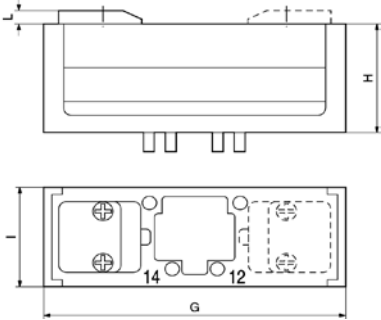

With P2F solenoids

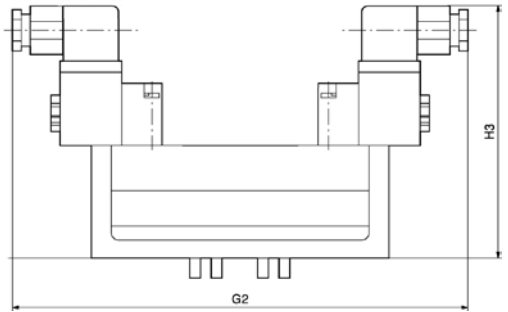

	G	G2	H	H3	I	L
Size 1	120	196	46	114	42	5
Size 2	140	206	58	126	54	5
Size 3	170	224	72	140	68,5	5

Solenoid operators (Mobile Metal) - 30 x 30mm

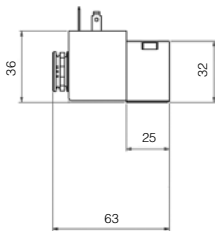
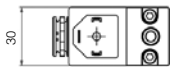

**Cable plugs
 3EV290V10**

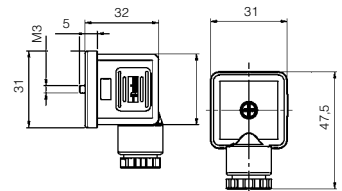

Single subbase with side ports according to VDMA - Dimensions

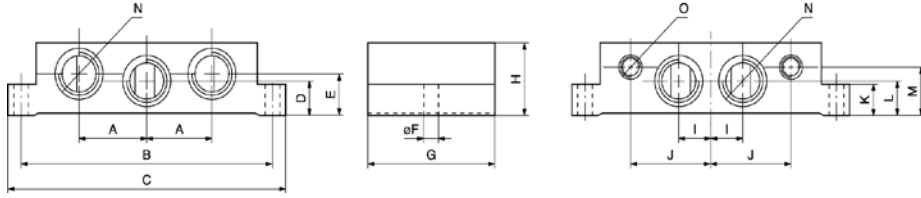

Order code	Size ISO	Port Size	A	B	C	D	E	F	G	H	I	J	K	L	M	N	O
P2N-VS512SD	1	G1/4	21,5	98	110	11	20	5,5	48	32	12	29	10	11	23	G1/4	G1/8
P2N-WS513S	2	G3/8	28	112	124	14	26	6,6	56	40	15	37	13	14	30	G3/8	G1/8
P2N-YS514SD	3	G1/2	34	136	149	17	17	6,6	71	32	16	45	18	17	22	G1/2	G1/8

Single subbase with side ports

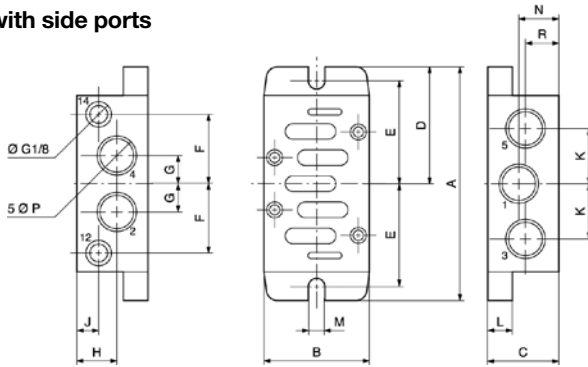

Order code	ISO Size	ØP	A	B	C	D	E	F	G	H	J	K	L	M	N	R
PL1-1/4-70	1	G1/4	110	46	29	55	49	30	11	17,75	17,75	22	6	5,5	17,75	17,75
PL2-3/8-70	2	G3/8	124	56	37	62	55	37	14,5	22,5	14	28	6	5,5	22,5	14,5
P2N-JS516SD	3	G3/4	149	71	60	74,5	68	45	21	33	10	40	18	6,6	37,5	22,5

Single subbase with bottom ports

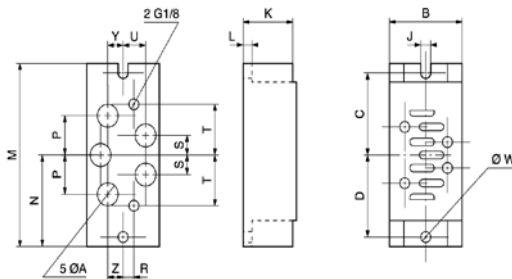

Order code	A	B	C	D	J	K	L	M	N	P	R	S	T	U	W	Y	Z
PD1-1/4-70	G1/4	46	49	49	5,5	29	6	110	55	22	10	11	30	10	5,5	10	10
PD2-3/8-70	G3/8	56	55	55	5,5	37	6	124	62	29	10	14,5	37	12,5	5,5	12,5	12,5
PD3-1/2-70	G1/2	77	68	68	6,6	32	18	149	74,5	34	10	17	45	17	6,5	17	17

Manifold and end plates according to VDMA (P2N-VM / WM / YM) - Dimensions

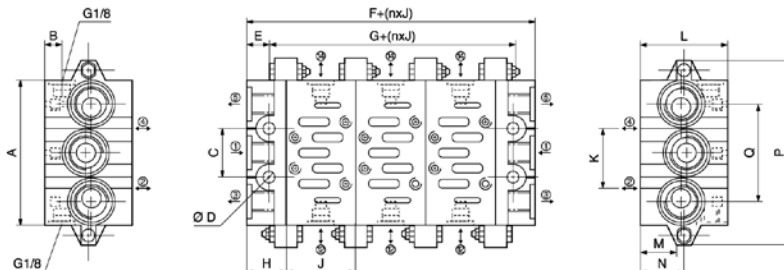

ISO Size	Port 1, 3, 5	Port 2, 4	A	B	C	D	E	F	G	H	J	K	L	M	N	O	P
1	G3/8	G1/4	85	8,5	28	7	11	44	22	22	43	26	46	21	24	56	110
2	G1/2	G3/8	100	9	35	9	13	52	26	26	56	30	47	22	24	68	135
3	G1	G1/2	140	10	52	12	15	60	30	30	71	38	56	31	34	104	190

Manifold and end plates with bottom ports "low profile" (P2N-AM..)

Manifold P2N-AM512MB

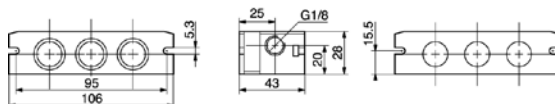

Connecting block P2N-AM513GT

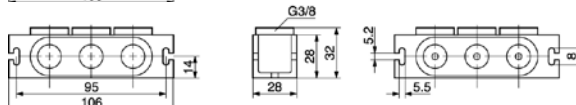

End piece P2N-AM500J

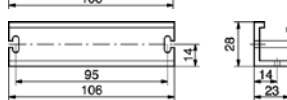

Intermediate supply P2N-AM513BT

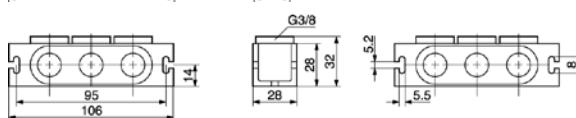

Manifold and end plates with side ports (P2N-EM / FM..)

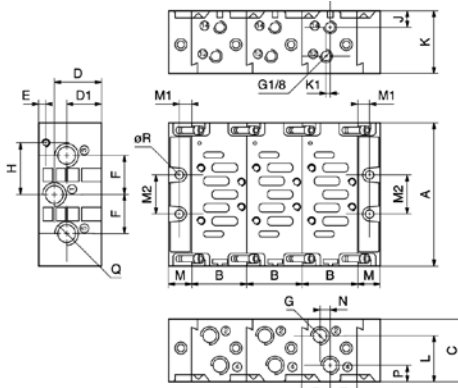

Order code	A	B	C	D	D1	E	F	G	H	J	K	K1	L	M	M1	M2	N	P	Q	R
P2N-EM ...	110	43	48	35,5	26,5	5,5	28	G1/4	36	15,5	35	3	32	20	11	28	12	12,5	G3/8	6
P2N-FM ...	129	56	60	44,5	35,5	6	34,5	G3/8	45	16	41,5	3	41	24	13	35	12,5	16	G1/2	8

E

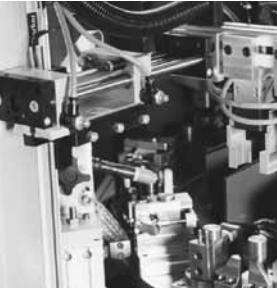

Moduflex Valve System

Instant control for all pneumatic actuators

Moduflex Valve System

The Moduflex Valve System redefines flexibility for pneumatic users. Whether configured from basic components or ordered as a pre-assembled and tested valve island, Moduflex flexibility is unmatched in the market place.



V Series



T Series



S Series



P Series

Innovative

The 6 patents awarded to the Moduflex Valve System reflect that innovation is core to the Parker design process. Maintaining a clear understanding of our customer's expectations has defined the individuality of the Moduflex, and clearly differentiated it as a leading automation solution.

Adaptive

No other system can be adapted so simply once specified. Unique, captive fitting release system, quick release electrical connectors and single mechanical screw connection between manifolds offer the ultimate capability for late system design changes.

Multi-Functional

From stand-alone valves to fieldbus ready valve islands, from cylinder flow controls to vacuum generators with integrated blow-off, the Moduflex Valve System meets the requirements of the whole automation spectrum.

Light-weight

An As-i compatible valve manifold with 8 electrical inputs and 8 pneumatic outputs weighs a mere 800grams, making the Moduflex Valve System the perfect choice for end of arm tooling application.

Moduflex Valve technology

Two technology platforms enable the compact design and high performance of the Moduflex Valve System. The compact dual 4/2 and 3/2 valves utilize well proven Parker seal technology. The standard 4/2 valves adopt the long life super durable ceramic switching technology.

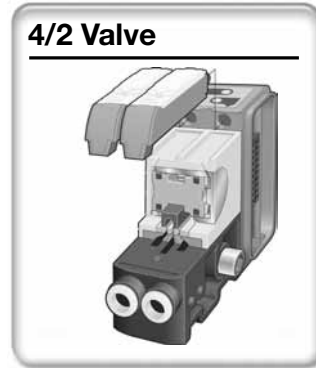
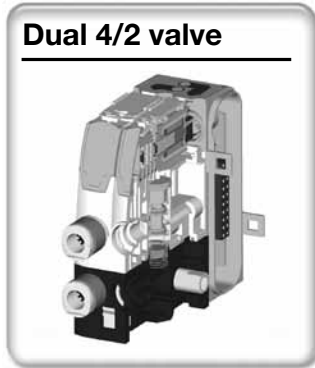

F

Moduflex Complete Control

With the introduction of the dual 4/2 size 1 valves, Moduflex now offers unrivaled ability of matching valves to exact flow requirements, ensuring cost and space are minimized. In addition, Moduflex Valve System offers all the necessary control peripherals to provide a complete automation solution. Moduflex is the complete control package.

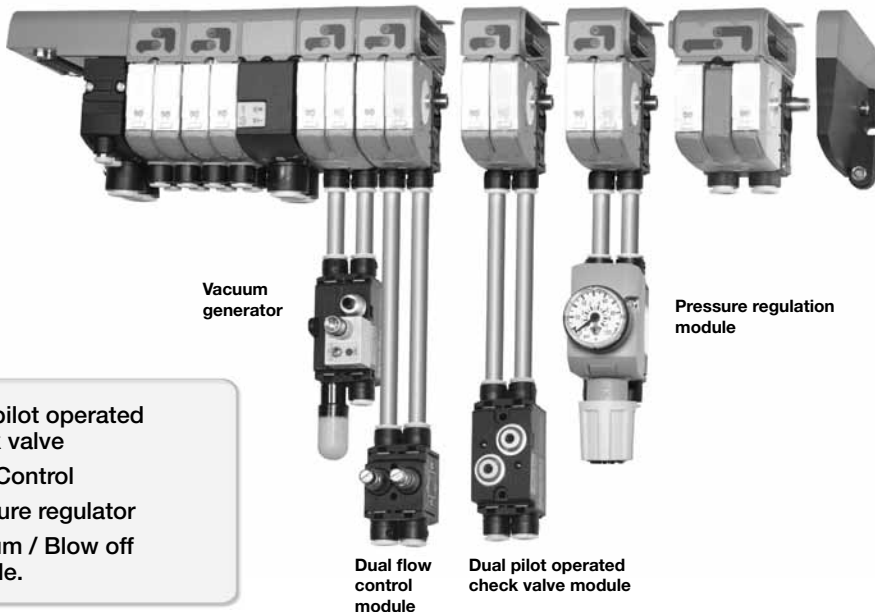

With high performance technology, Moduflex opens a new era in the field of electro-pneumatic automation. Valves are easily assembled into compact islands that conform to any application requirement.

Adaptive pneumatic

With the Moduflex Valve design, pneumatic automation is now totally flexible.

- Valves may be stand-alone or assembled into short or long islands, depending on application.
- IP 65-67 water and dust protection allows valve to be installed near the cylinders for shorter response time and lower air consumption.
- Valve island electrical connections may be integrated.
- Push-in pneumatic connectors may be straight or elbow, for 4, 6, 8 or 10 mm OD tubes.
- A given island may incorporate different valve sizes in order to fulfill each cylinder flow requirement. A single island will accommodate all cylinders, up to 100 mm bore size.
- Island modifications are easy : add or remove a valve, change a valve function, change tubing size, change piloting in minutes.
- Manual overrides are also adaptive : locking for set up, non-locking for production, ...

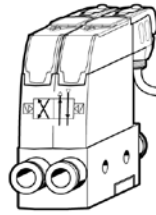

stand-alone valve

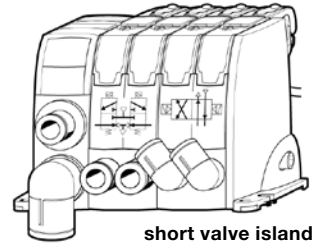

short valve island

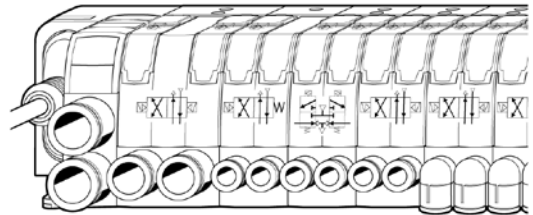

or long valve island

straight or elbow pneumatics connectors

F

Easy man-machine dialog

- Moduflex incorporates LED indicators, manual overrides (MAN), in conjunction with valve symbols and identification.
- As compared to traditional 5/2 valve islands, Moduflex offers a more user friendly dialog : each marking, LED and MAN are all lined up with the corresponding cylinder output.

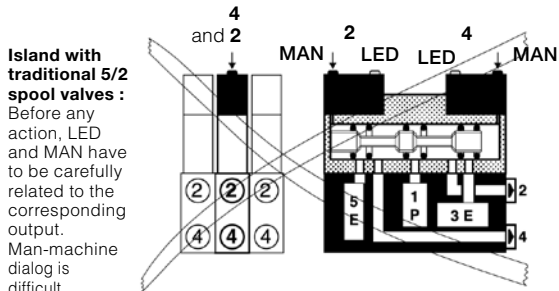
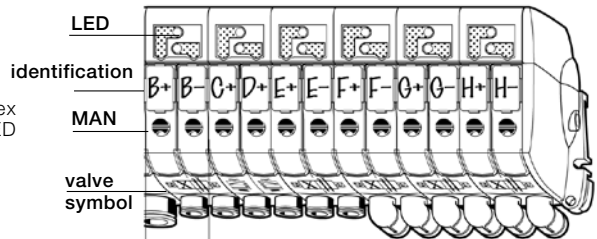

Island with traditional 5/2 spool valves : Before any action, LED and MAN have to be carefully related to the corresponding output. Man-machine dialog is difficult.

Island with Moduflex 4/2 slides valves: Each marking, LED and MAN line up with the corresponding output.

Man-machine dialog is easy.

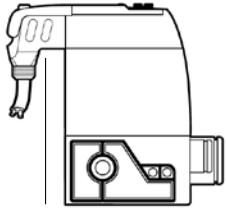

individual electrical connector

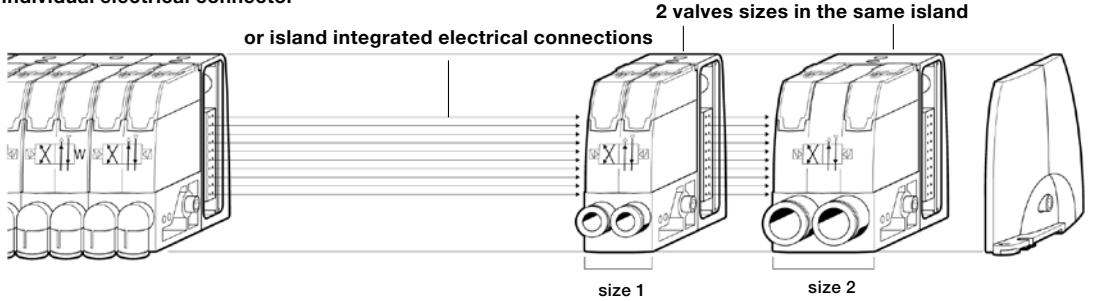

Flows and tube connections

2 valves sizes lead to a global choice of 4 tubes sizes, thus covering all usual applications

Size 1

Flow : Qmax. > 400 NI/min

12 mm² flow channel, for 4 and 6 mm OD tubes

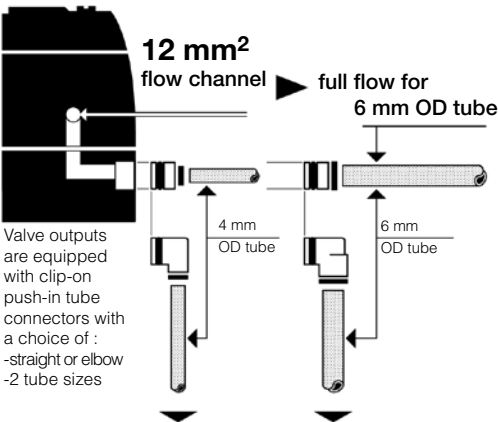

Valve outputs are equipped with clip-on push-in tube connectors with a choice of :
 -straight or elbow
 -2 tube sizes

to cylinders 6 to 25 mm bore size 25 to 40 mm bore size

Size 2

Flow : Qmax. > 1200 NI/min *

40 mm² flow channel, for 8 and 10 mm OD tubes

* except 3/2 and dual 4/2 functions

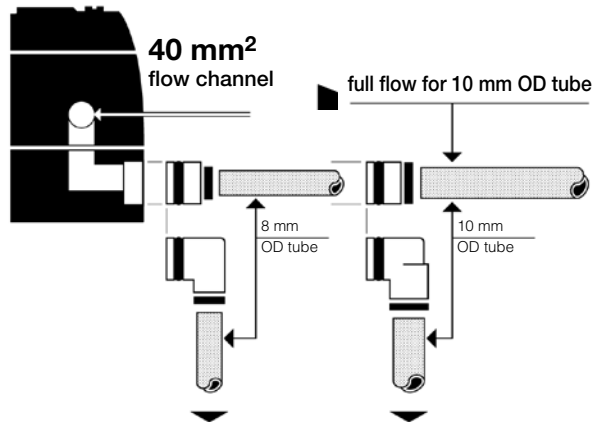

to cylinders 40 to 63 mm bore size 63 to 100 mm bore size

Cylinder working speed charts

The charts below give the cylinder working speeds at 6 bar, under different conditions :

- non loaded or 50 % loaded double acting cylinder ;
- exhaust piped through 2 m. long tubing, or exhaust muffled.

cylinder working speeds, in cm/s

standard conditions :

- double acting cylinder
- working pressure : P = 6 bar

specific conditions :

- exhaust piped through tube 2 m long, with next ID above ID tube from valve to cylinder.

- non loaded cylinder

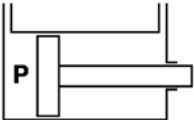

valve module	tube ID	tube OD	tube length	cylinder bore size								
				25 mm	32 mm	40 mm	50 mm	63 mm	80 mm	100 mm		
Size 1	2 x 4 mm	4 mm	1 m.	43 cm/s	28 cm/s							
			3 m.	27	17							
	2.7 x 4 mm	4 mm	1 m.	85	52	33 cm/s						
			3 m.	55	34	21						
	4 x 6 mm	6 mm	1 m.	167	100	62	41 cm/s	27 cm/s				
			2 m.	157	86	54	37	23				
			4 m.	125	73	46	31	19				
			8 m.	94	57	36	24	14				
Size 2	5.5 x 8 mm	8 mm	1 m.			146	102	67	40 cm/s	25 cm/s		
			3 m.			122	84	54	32	20		
	6 x 8 mm	8 mm	1 m.				125	78	46	30		
			3 m.				105	65	39	25		
	7 x 10 mm	10 mm	1 m.				135	88	53	33		
			3 m.				120	77	47	30		
	8 x 10 mm	10 mm	1 m.					94	57	40		
			3 m.					85	53	37		

cylinder working speeds, in cm/s

standard conditions :

- double acting cylinder
- working pressure : P = 6 bar

specific conditions :

- exhaust piped through tube 2 m long, with next ID above ID tube from valve to cylinder.

- 50% loaded cylinder

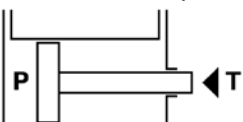

valve module	tube ID	tube OD	tube length	cylinder bore size							
				25 mm	32 mm	40 mm	50 mm	63 mm	80 mm	100 mm	
Size 1	2 x 4 mm	4 mm	1 m.	32 cm/s	20 cm/s						
			3 m.	21	13						
	2.7 x 4 mm	4 mm	1 m.	65	43	25 cm/s					
			3 m.	43	27	16					
	4 x 6 mm	6 mm	1 m.	100	85	53	36 cm/s	22 cm/s			
			2 m.	93	75	44	30	19			
			4 m.	83	62	36	24	15			
			8 m.	68	46	27	18	11			
Size 2	5.5 x 8 mm	8 mm	1 m.			83	67	44	27 cm/s	18 cm/s	
			3 m.			79	54	35	21	15	
	6 x 8 mm	8 mm	1 m.				77	51	32	21	
			3 m.				69	43	26	17	
	7 x 10 mm	10 mm	1 m.				88	59	37	24	
			3 m.				81	51	30	21	
	8 x 10 mm	10 mm	1 m.					63	39	27	
			3 m.					58	35	25	

Field of application :

- stand-alone valve modules **S** series
- valve island modules, **T** series and **V** series

Note : a complete machine cycle includes :
 - the cylinder displacement times that can be deducted from the cylinder speeds given below
 - the cylinders starting times that depend on the cylinder strokes and thus could not be included in the charts below.

cylinder working speeds, in cm/s

standard conditions :

- double acting cylinder
- working pressure : P = 6 bar

specific conditions :

- exhaust piped through tube 2 m long, with next ID above ID tube from valve to cylinder.

■ non loaded cylinder

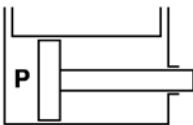

				cylinder bore size							
valve module	tube ID	tube OD	tube length	25 mm	32 mm	40 mm	50 mm	63 mm	80 mm	100 mm	
Size 1	2 x 4 mm	1 m.		43 cm/s	27 cm/s						
			3 m.	27	17						
	2.7 x 4 mm	1 m.		88	54	34 cm/s					
			3 m.	55	34	22					
	4 x 6 mm	1 m.		170	98	62	42 cm/s	26 cm/s			
			2 m.	150	85	55	37	23			
		4 m.		125	70	45	31	19			
			8 m.	95	56	35	24	15			
Size 2	5.5 x 8 mm	1 m.				181	126	80	48 cm/s	30 cm/s	
			3 m.			134	91	58	35	22	
	6 x 8 mm	1 m.					139	89	54	34	
			3 m.				112	70	43	27	
	7 x 10 mm	1 m.					148	94	57	37	
			3 m.				125	81	49	31	
	8 x 10 mm	1 m.							102	60	42
			3 m.						90	55	38

cylinder working speeds, in cm/s

standard conditions :

- double acting cylinder
- working pressure : P = 6 bar

specific conditions :

- exhaust piped through tube 2 m long, with next ID above ID tube from valve to cylinder.

■ 50% loaded cylinder

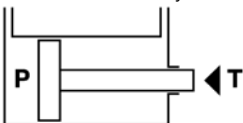

				cylinder bore size							
valve module	tube ID	tube OD	tube length	25 mm	32 mm	40 mm	50 mm	63 mm	80 mm	100 mm	
Size 1	2 x 4 mm	1 m.		35 cm/s	22 cm/s						
			3 m.	23	14						
	2.7 x 4 mm	1 m.		67	44	27 cm/s					
			3 m.	44	28	17					
	4 x 6 mm	1 m.		100	87	56	38 cm/s	23 cm/s			
			2 m.	93	77	46	31	19			
		4 m.		83	63	37	25	16			
			8 m.	69	46	28	18	12			
Size 2	5.5 x 8 mm	1 m.				102	85	54	33 cm/s	22 cm/s	
			3 m.			87	61	40	24	16	
	6 x 8 mm	1 m.					91	59	37	25	
			3 m.				77	46	29	19	
	7 x 10 mm	1 m.					98	63	40	26	
			3 m.				87	54	33	22	
	8 x 10 mm	1 m.							68	43	30
			3 m.						61	38	27

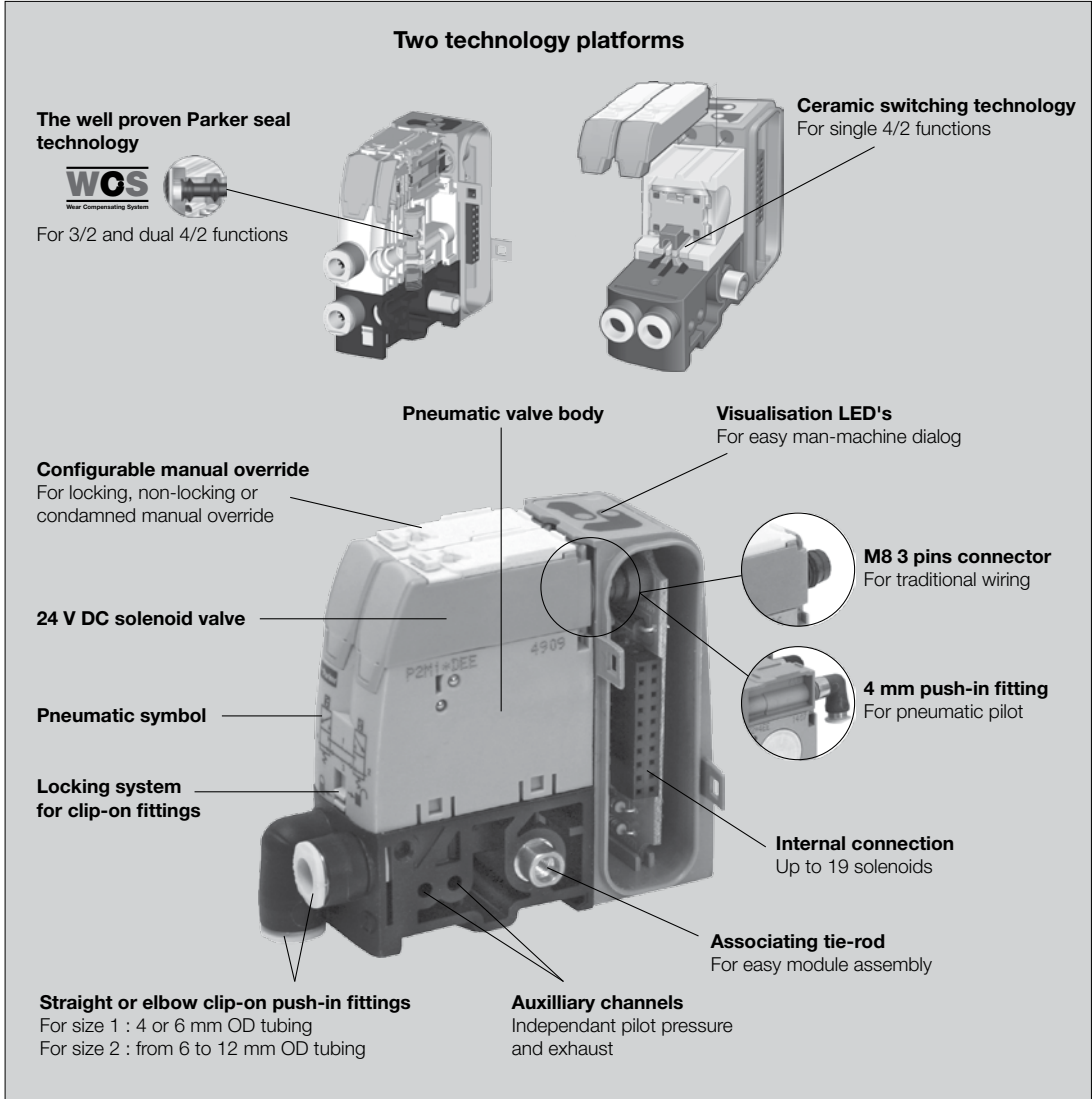

Material Specification

Plastics	: Polyamide reinforced fibreglass
Screws	: Zinc plated steel
Seals	: Nitrile rubber
Valve mechanism	: Aluminium alloy
Plate	: Ceramic

Certification

EMC / CE mark	: According to EN 61 000-6-2
Dust & water protection	: According to EN 60529 - NEMA 4
- S & T series	: IP67
- V series	: IP65*

* For Sub-D 25 connection : IP40 or IP65 depending on the cable

Moduflex specifications answer most industries automation requirements.

Applications run from clean room electronic manufacturing to process industries in aggressive environments.

Pneumatic specifications

General specifications	
Fluid	Air, inert gas, filtered 40 µ ^① , dry ^② or lubricated ^③
Operating pressures	- 0.9 to 8 bar
Piloting pressures	3 to 8 bar ④ for operating pressures below, use external pilot supply available on all head modules
Pilot supply	Internal with S series, mixed internal/external with T and V series
Exhaust collection	All exhausts are collectable, including solenoid pilot exhaust
Life cycle	100 million operations ⑤ (with dry air, 3 Hz, 20°C, 6 bar)
Operating temperatures	- 15°C to 60°C (0° C to 55°C for field bus systems)
Stocking temperatures	- 40°C to 70°C
Vibration resistance	According to IEC 68 - 2 - 6 2G 2 to 150 Hz
Impact resistance	According to IEC 68 - 2 - 27 15G 11 ms
	① class 5 according to ISO 8573-1 ② class 4 according to ISO 8573-1 ③ with lubricated air, we recommend external pilot supply with non lubricated air ④ For 2 x 3/2 and 3/2 piloting pressure : 3.5 to 8 bar ⑤ For 4/2 valve

Flow specifications		Dual 4/2	Dual 3/2	Single 3/2	Single 4/2
Size 1	Q max. (NI/mn)	275	415	415	510
	Qn (NI/mn)	165	235	235	310
Size 2	Q max. (NI/mn)	-	805	805	1340
	Qn (NI/mn)	-	450	440	800

Electrical specifications

Solenoid pilot specifications				
 <p>Solenoid pilot common to all the Moduflex system</p>	Rated coil voltage	24 V DC		
	Allowable voltage fluctuation	- 15 % to + 10 % of rated voltage at 20° C		
	Electrical connection	Polarity insensitive : PNP and NPN compatible		
	Coil insulation type	Class B		
	Power consumption	1 W (42 mA)		
	Manual override	Configurable: Locking or non-locking, isolated if required		
	Response time of the complete valve	4/2 bistable valve size 1	9.6 ms ± 1.2 on 4/2	According to ISO 12238
		4/2 bistable valve size 2	14.8 ms ± 2 on 4/2	
	Duty factor	100 %		
	Dust and water protection	According to EN 60 529, NEMA4	S and T series	: IP 67
		V series	: IP 65 *	
				* For Sub-D 25 connection : IP40 or IP65 depending on the cable

Communication module specifications					
All protocols	EMC / CE mark	According to	EN 61 000-6-2	EN 50081-2	
AS-interface	AS-i line	According to	EN 50295		
	Module consumption	70 mA max. (2 slaves)			
	Max supply for all inputs	240mA (including internal input consumption)			
	Internal input consumption	9 mA for each active input			
Device protocols	Inputs	According to IEC 1131-2 classe 2			
		Profibus DP	DeviceNet	CANopen	
		interBus-S			
	Bus line	According to each bus specification			
	Module Voltage	20 to 30 V DC			
	Module consumption	1,5 W max.	1,5 W max.	1,5 W max.	2 W max.
	Outputs	Overload protection			

Technical characteristics

Vacuum module

Fluid

Compressed air or inert gas, filtered 40µ mini., not lubricated

Working pressure

1 to 8 bar

Working temperature

-15°C to +60°C

Materials

Body : Polyamide 6,6 reinforced fibreglass

Poppet : Nitrile

Nozzle : Brass

Clip connector : Treated steel

F

Pressure sensor

Fluid

Air or inert gas, filtered 40µ mini., not lubricated

Working temperature

0°C to +50°C

Supply

10,8 to 30 V DC

Digital output

PNP 125 mA

Materials

Body : Polycarbonate

Connection drawing

Electrical or pneumatic actuated valves

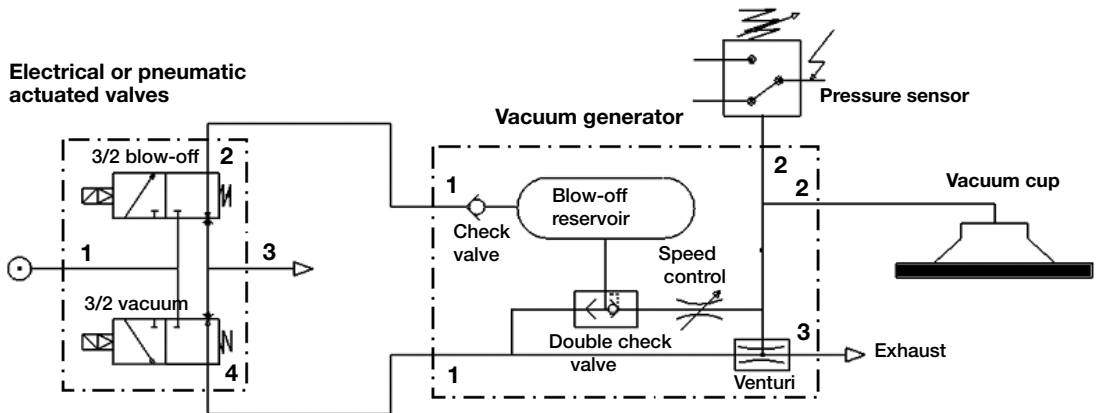

Specific characteristics

Maximum vacuum
 Vacuum level : 90% at 6,5 bar

Air consumption
 Consumption : 46 NI/min at 5 bar

Vacuum flow
 Flow : 25NI/min at 0 % vacuum and 6,5 bar

Evacuation time in s/l to reach different vacuum levels % (at P = 6,5 bar)

Vacuum %	0	10	20	30	40	50	60	70	80	90
Time in s	0,0 / 0,0	0,3 / 0,3	0,4 / 0,5	0,8 / 0,9	1,4 / 1,5	2,0 / 2,2	2,7 / 3,2	3,7 / 4,9	5,9 / 9,8	10,7 / -
Flow in NI/min	24,9 / 23,2	22,1 / 20,3	19,3 / 17,3	16,6 / 14,4	13,8 / 11,5	11,0 / 8,5	8,2 / 5,6	5,5 / 2,7	2,7 / 0,0	0,0 / -

With silencer / With captured exhaust *

Performances

Vacuum level

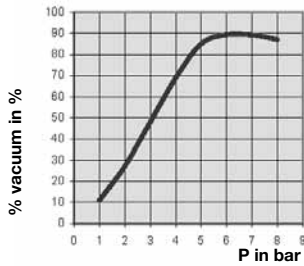

Vacuum flow

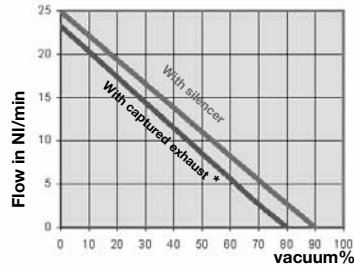

* 1 m exhaust - tube Ø6 mm
 3 m exhaust - tube Ø8 mm

Air consumption

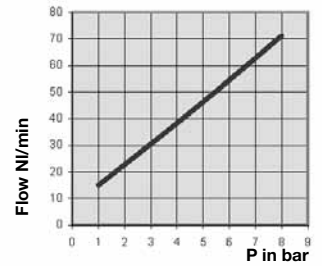

Operating information

Working pressure: -0,9 to 8 bar
 Pilot pressure: 3 to 8 bar *
 Working temperature: -15 °C to 60 °C
 Protection individual connectors: IP 67 NEMA4
 Protection integrated connectors: IP 65
 Voltage: 24 V DC

		Dual 4/2	Dual 3/2	3/2	4/2
Size 1	Qmax.	275 l/min	415 l/min	415 l/min	510 l/min
	Qn	165 l/min	235 l/min	235 l/min	310 l/min
Size 2	Qmax.	-	805 l/min	805 l/min	1340 l/min
	Qn	-	450 l/min	440 l/min	800 l/min

* Single and double 3/2: 3,5 to 8 bar

Total ordering flexibility

Additionally to the complete product adaptability, the Moduflex Valve range offers for V, T, S and P series an ordering flexibility with 3 different designs; from all components separately ordered (basic module) to pre-assembled and tested valve island.

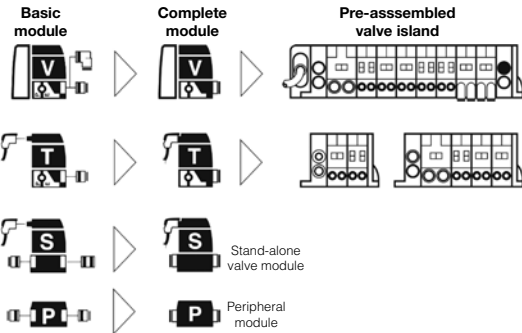

The Moduflex Valve Island Configurator software is the easy way to, step by step, configure and order the required valve island for the application.

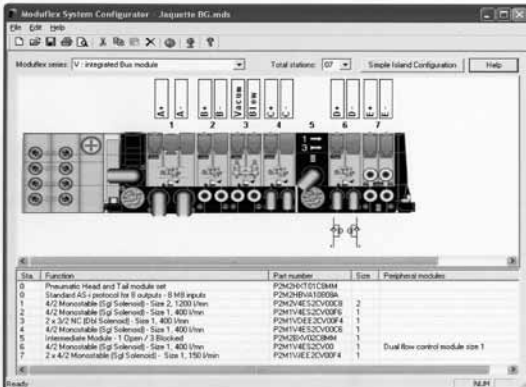

Ordering options

1 - Basic modules ordering

Using this option, all basic components are separately ordered :

- Head and Tail set
- Valve modules
- Intermediate module kit
- Peripheral modules
- Pneumatic connectors, mufflers and plugs
- Electrical connection or fieldbus module

The complete bill of material needed for the valve island assembly can be easily details using page 1 of the Moduflex Valve Configurator software report.

2 - Complete modules ordering

Using this option, modules are defined, ordered and supplied, pneumatic connectors and electrical connection equipped. One part number defines :

- Function module
- Pneumatic connectors, muffler and plugs
- Electrical connection and cable

For an entire valve island configuration, the list of complete modules can be easily details using page 3 of the Moduflex Valve Configurator software report.

3 - Pre-assembled valve islands ordering

Using this option, the complete valves island configuration has to be defined, and may be ordered, delivered fully assembly and tested under one part number.

The Moduflex Valve Configurator software is an easy way for a clear definition of the requested valve island configuration.

V series

Integrated connection field bus or multi-connector valve island

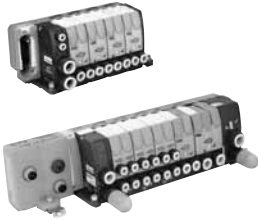

T series

Individual connector valve islands
Solenoid or air pilot



S series

Stand alone valves
Solenoid or air pilot



P series

Peripheral modules
Flow control, check valves,
pressure regulator, vacuum



F



Moduflex Valve Configurator software

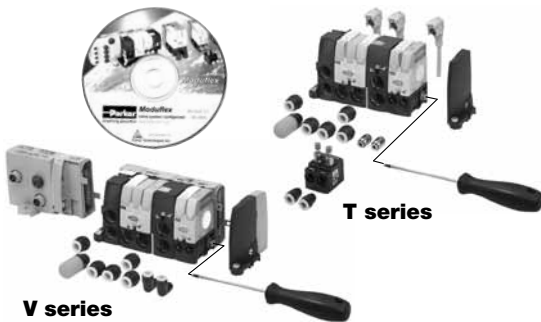

Integrated connections valve islands : V series

In a V series Moduflex valve island, electrical controls are all received by the head module and transmitted to the concerned valve modules through the modular integrated circuit.

The head module may either be a cable multi-connector or a Fieldbus communication module : the next pages show multi-connector cable and a complete choice of bus protocols.

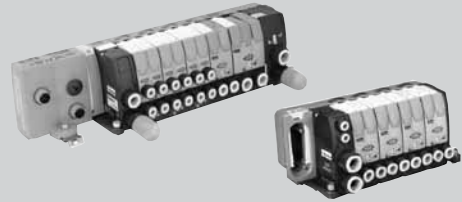

Valve island configuration

The following page shows all valve sizes and functions that may enter into a V series valve island and, for each valve size, a choice of clip-on pneumatic connectors : tubing size, straight, elbow...
To receive its pressure supply and collect its exhaust, the island also requires a pneumatic

head and tail module set and sometimes an intermediate module set with 4 configuration plates for different functions. To receive its electrical controls, the island is completed by an electrical head module, either a multi-connector or by a bus module to be chosen from the next pages.

F

Valve island electrical head module : multi-connector or field bus connection

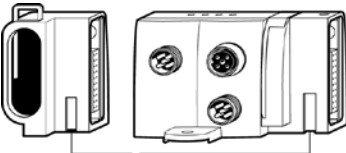

Pneumatic head module

1 Island head module assembly

2 Valve island assembly

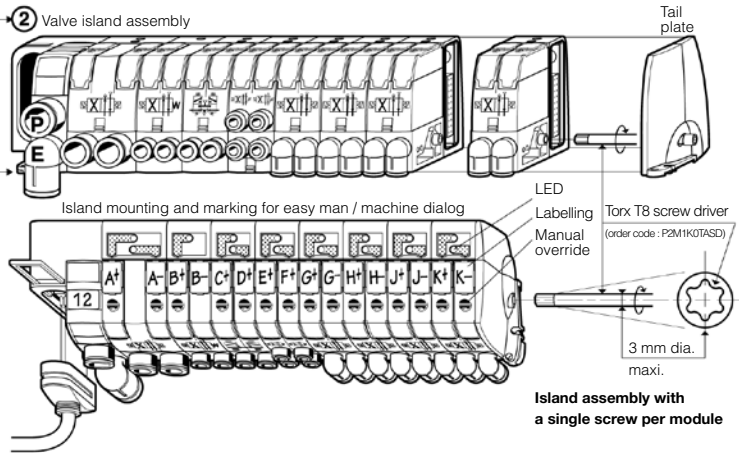

Valve island assembly

The above illustration presents :

- **Step 1** the electrical head module is engaged into the pneumatic head module ;
- **Step 2** valve modules are one by one screwed onto each other starting from the head module. For this task, the single integrated screw is tightened with a torx T8 standard screwdriver.

The pneumatic connectors may be clipped or unclipped at any stage.

With a LED, a manual override and a labelling for each valve pilot (see illustration), the island front face eases the "man / machine" dialog.

The resulting valve island length is expressed by the drawing below, while further size details and mountings are presented on dimensions pages.

Modules and island ordering

Choice between 3 approaches :

1 - Basic modules ordering :
The following page shows these modules supplied without connector, together with the choice of clip-on connectors separately supplied (10 units packs). This approach gives the maximum flexibility.

2 - Complete modules ordering :

Page 27 shows the ordering chart for modules supplied with their connectors.

3 - Assembled island ordering :

Page 30 shows the valve island configurator CD-Rom to specify a valve island that may be delivered assembled.

Field bus head module :
■ width : 94 mm

Multi-connector head module :
■ guillotine, width : 47 mm
■ sub-D 25, width : 56 mm

Valve modules size 1 :
■ width : 25 mm

Valve module size 2 :
■ width : 37.5 mm





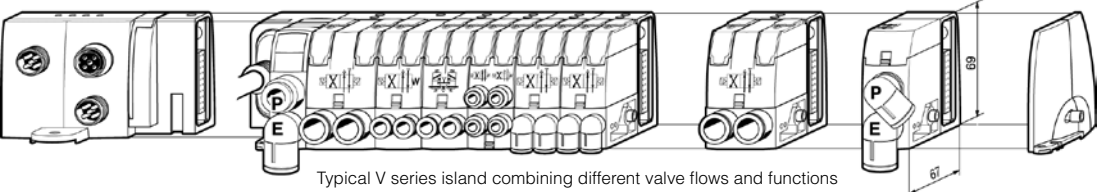





Intermediate module :
■ width : 25 mm

Tail plate :
■ width : 16 mm



Typical V series island combining different valve flows and functions



Basic modules (without connector)

Valve Modules		Size 1			Size 2	
	Symbol	Description	Weight (g)	Order code	Weight (g)	Order code
 <p>Size 1</p>		4/2 Solenoid spring	94	P2M1V4ES2CV	100	P2M2V4ES2CV
		4/2 Double solenoid	103	P2M1V4EE2CV	110	P2M2V4EE2CV
		2 x 3/2 NC + NC with exhaust check valves	106	P2M1VDEE2CV	115	P2M2VDEE2CV
		2 x 3/2 NO + NO with exhaust check valves	106	P2M1VCEE2CV	115	P2M2VCEE2CV
 <p>Size 2</p>		2 x 3/2 NC + NO with exhaust check valves	106	P2M1VEEE2CV	115	P2M2VEEE2CV
		2 x 4/2 Solenoid spring with exhaust check valves	114	P2M1VJEE2CV		
		3/2 NC with exhaust check valves	102	P2M1V3ES2CV	110	P2M2V3ES2CV
		4/3 Centre exhaust 2 x 3/2 NC + NC without exhaust check valves	106	P2M1VGEE2CV	115	P2M2VGEE2CV

Island head and intermediate module sets

Valve Modules		Size 2	
	Description	Weight (g)	Order code
 <p>P2M2HXT01</p>	Valve island pneumatic head and tail module set	64	P2M2HXT01
	Valve island intermediate supply module with a set of 4 configuration plates	68	P2M2BXV0A

Clip-On pneumatic connectors *



Valve Modules		Size 1			Size 2	
	Description	Tube OD	Weight (g)	Order code	Weight (g)	Order code
	Straight connector	G1/8"	2	FMDG1-1		
		4 mm	2	FMD04-1		
		6 mm	3	FMD06-1	3	FMD06-2
		8 mm			4	FMD08-2
		10 mm			5	FMD10-2
	Elbow connector	G1/8"	3	CMDG1-1		
		4 mm	3	CMD04-1		
		6 mm	5	CMD06-1	5	CMD06-2
		8 mm			6	CMD08-2
		10 mm			7	CMD10-2
	Silencer				5	MMDVA2
	Plug		3	PMDXX1	5	PMDXX2

* Fittings and plugs pack quantity : 10

Electrical multi-connection and field bus head modules

Multiconnector or field bus head module to be chosen from next pages.



V series valve island : Electrical multi-connector head module

	Description	Protection	Cable length	Weight (g)	Order code	
	Guillotine type	Multi-connection head module		38	P2M2HEV0A	
		Guillotine connector with flying leads	IP65	2 m	335	P8LMH20M2A
				5 m	802	P8LMH20M5A
				9 m	1425	P8LMH20M9A
	Standard Sub-D 25 type	Multi-connection head module		60	P2M2HEV0D	
		Sub-D 25 connector with flying leads	IP40	3 m	435	P8LMH25M3A
				9 m	1425	P8LMH25M9A
			IP65	9 m	1425	P8LMH25B9A

F

V series valve island : Electrical field bus head modules for AS-i protocol



	Description	No outputs / node add.	Input connections	Weight (g)	Order code
	Standard AS-i protocol (Up to 31 nodes)	8 Outputs / 2 addresses	No. input	150	P2M2HBVA10800
			8 M8 inputs	200	P2M2HBVA10808A
			8 inputs on 4 M12	200	P2M2HBVA10808B
		4 Outputs / 1 address	No. input	150	P2M2HBVA10400
			4 inputs on 4 M12	200	P2M2HBVA10404B
	Extended AS-i protocol (Up to 62 nodes - A/B coding)	8 Outputs / 2 addresses	No. input	150	P2M2HBVA20600
			8 M8 inputs	200	P2M2HBVA20608A
			8 inputs on 4 M12	200	P2M2HBVA20608B

AS-i head module accessories

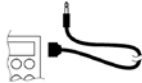
	Description	Connector type	Weight (g)	Order code
	Cable quick connect connector	M8 Male	25	P8CS0803J
		M12 Male - A coding	25	P8CS1204J
	« Y » shape	M12 Male - 2 x M12 Female	25	P8CSY1212A
	Addressing cable 1 meter	M12 Male - Jack	100	P8LS12JACK

V series valve island : Electrical field bus head modules for device bus

Electrical modules for 16 outputs
 (The V series modules may have up to 16 solenoid pilot valves)

	Description	Bus Protocol	Bus In / Bus Out	Power supply	Weight (g)	Order code
	Moduflex Bus Communication module	Profibus DP For GSD file, go to http://www.parker.com/pneu/moduflex	M12 - B coding	M12 - A coding	250	P2M2HBVP21600
		DeviceNet For EDS file, go to http://www.parker.com/pneu/moduflex	M12 - A coding	M12 - A coding	250	P2M2HBVD21600
		CANopen For EDS file, go to http://www.parker.com/pneu/moduflex	M12 - A coding	M12 - A coding	250	P2M2HBVC21600
		InterBus-S	M23 - 9 Pins	M12 - A coding	300	P2M2HBVS11600

Device Bus connection accessories

	Description	Bus Protocol	Connector type	Weight (g)	Order code
 <p>P2M2HBVP21600</p> <p>P8CS1205AA</p>	Power supply female straight connector	All	M12 - A coding	25	P8CS1205AA
	Bus IN female connector	DeviceNet CANopen	M12 - A coding	25	P8CS1205AA
		Profibus DP	M12 - B coding	25	P8CS1205AB
	Bus OUT male connector	DeviceNet CANopen	M12 - A coding	25	P8CS1205BA
		Profibus DP	M12 - B coding	25	P8CS1205BB
	Line termination	DeviceNet CANopen	M12 - A coding	25	P8BPA00MA
	Profibus DP	M12 - B coding	25	P8BPA00MB	



M12 - A coding connector



M12 - B coding connector

Individual connection valve islands : T series

In a T series valve island, electrical controls are individually connected to each valve module, onto its solenoid pilot.

As an alternative, air pilot valve modules are also available, to be controlled by individual pneumatic signals.



Valve island assembly

F

As shown by the above illustration, the valve modules are one by one screwed onto each other, starting from the head module. For this task, the single integrated screw is tightened with a torx T8 standard screwdriver.

The pneumatic connectors may be clipped or unclipped at any stage.

With a LED, a manual override and a labelling for each valve pilot (see above illustration), the island front face eases the "man / machine" dialog.

The resulting valve island length is expressed by the drawing below, while further size details and mountings are presented on dimensions pages.

Valve island configuration

The following page presents all valve sizes and functions that may enter into a T series valve island and, for each valve size, a choice of clip-on pneumatic connectors : tubing size, straight, elbow...

To receive its pressure supply and collect its exhaust, the island also requires a

pneumatic head and tail module set and sometimes an intermediate module set including 4 configuration plates for different functions.

Valve modules may either be solenoid versions or air pilot versions. Mixing both versions into the same valve island is possible.

Valve pilot connections

1 - Solenoid valve modules

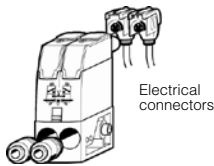

Electrical connectors

Each solenoid shows a M8 connection. Lockable clip-on connectors, IP67 protected, with LED, voltage surge protection and flying lead cable may be ordered for the required length.

2 - Air pilot valve modules

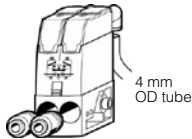

4 mm OD tube

No connector has to be ordered : each pneumatic pilot port includes its integrated swivable elbow 4 mm OD tube push-in connector.

Typical T series short island for single or double acting small cylinders.

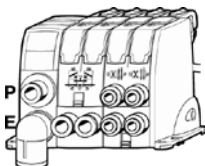

Valve island assembly

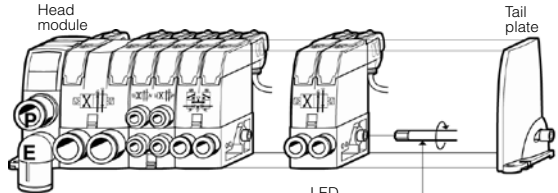

Island mounting and marking for easy man / machine dialog

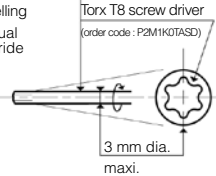
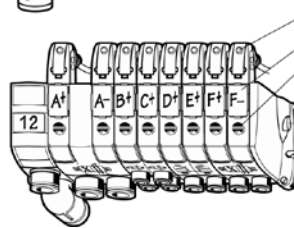

Island assembly with a single screw per module

Modules and island ordering

Choice between 3 approaches :

1 - Basic modules ordering :

The following page shows these modules supplied without connector, together with the choice of clip-on connectors separately supplied (10 units packs). This approach gives the maximum flexibility.

2 - Complete modules ordering :

Page 27 shows the ordering chart for modules supplied with their connectors.

3 - Assembled island ordering :

Page 30 shows the valve island configurator CD-Rom to specify a valve island that may be delivered assembled.





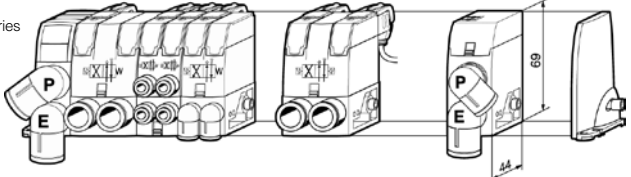





Pneumatic head module : width : 32 mm	Valve module size 1 : width : 25 mm	Valve module size 2 : width : 37.5 mm	Intermediate module : width : 25 mm	Tail plate : width : 16 mm
--	--	--	--	-------------------------------

Typical T series high flow island for both small and large cylinders.





Typical T series islands combining different valve flows and functions

Basic modules (without connector)



Valve Modules				Size 1		Size 2	
	Symbol	Description	Actuator	Weight (g)	Order code	Weight (g)	Order code
 <p>Size 1 Dual 4/2</p>		4/2 Spring return	Solenoid Air pilot	68 63	P2M1T4ES2C P2M1T4PS	74 69	P2M2T4ES2C P2M2T4PS
		4/2 Double pilot	Solenoid Air pilot	77 67	P2M1T4EE2C P2M1T4PP	83 73	P2M2T4EE2C P2M2T4PP
 <p>Size 1</p>		2 x 3/2 NC + NC with exhaust check valves	Solenoid Air pilot	80 70	P2M1TDEE2C P2M1TDPP	94 84	P2M2TDEE2C P2M2TDPP
		2 x 3/2 NO + NO with exhaust check valves	Solenoid Air pilot	80 70	P2M1TCEE2C P2M1TCPP	94 84	P2M2TCEE2C P2M2TCPP
		2 x 3/2 NC + NO with exhaust check valves	Solenoid Air pilot	80 70	P2M1TEEE2C P2M1TEPP	94 84	P2M2TEEE2C P2M2TEPP
 <p>Size 2</p>		2 x 4/2 Spring return with exhaust check valves	Solenoid Air pilot	88 78	P2M1TJEE2C P2M1TJPP		
		3/2 NC with exhaust check valves	Solenoid Air pilot	76 71	P2M1T3ES2C P2M1T3PS	90 70	P2M2T3ES2C P2M2T3PS
		4/3 Centre exhaust 2 x 3/2 NC + NC without exhaust check valves	Solenoid Air pilot	80 70	P2M1TGEE2C P2M1TGPP	94 84	P2M2TGEE2C P2M2TGPP

F

Island head and intermediate module sets

Valve Modules		Size 2	
	Description	Weight (g)	Order code
 <p>P2M2HXT01</p>	Valve island pneumatic head and tail module set	64	P2M2HXT01
	 <p>P2M2BXT0A</p>	Valve island intermediate supply module with a set of 4 configuration plates	64

Clip-On pneumatic connectors *

Valve Modules				Size 1		Size 2	
	Description	Tube OD	Weight (g)	Order code	Weight (g)	Order code	
	Straight connector	G1/8"	2	FMDG1-1			
		4 mm	2	FMD04-1			
		6 mm	3	FMD06-1	3	FMD06-2	
		8 mm			4	FMD08-2	
		10 mm			5	FMD10-2	
		12 mm			6	FMD12-2	
	Elbow connector	G1/8"	3	CMDG1-1			
		4 mm	3	CMD04-1			
		6 mm	5	CMD06-1	5	CMD06-2	
		8 mm			6	CMD08-2	
		10 mm			7	CMD10-2	
		12 mm			8	CMD12-2	
<p>* Fittings and plugs pack quantity : 10</p>	Silencer				5	MMDVA2	
	Plug		3	PMDXX1	5	PMDXX2	

Electrical connectors

Description	Connector type	Cable length	Weight (g)	Order code
 <p>Clip-on individual electrical connector, for each solenoid pilot IP67 protected, including LED, voltage surge protection and flying lead cable</p>	M8 / 2 x Flying leads	2 meters	62	P8LS08L226C
		5 meters	155	P8LS08L526C
		9 meters	180	P8LS08L926C
<p>Straight cable quick connect to thread connector, IP67 protected</p>	M8		12	P8CS0803J
	M12		15	P8CS1204J

Stand-Alone Valve Modules : S series

Very useful to control isolated cylinders, these stand-alone valves module are compact and easy to mount on the machines with neat electrical and pneumatic connections.

As an alternative to electrical controls, valves with air pilots are also available, to be controlled by individual pneumatic signals.

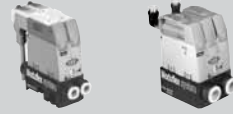

Valve functions

The following page shows all valve sizes and functions and, for each valve size, a choice of clip-on pneumatic connectors : tubing size, straight, elbow, ...

F

Valve main connections

- Outlets to cylinders (ports 2 and 4) on one side.
- Supply P (port 1) and exhaust E (port 3) on the other side. At port 3, exhaust may be collected or receive a clip-on muffler.

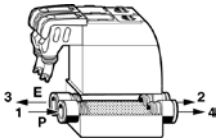

Valve mounting

All valves may be mounted either with side screws or with their integrated retractable brackets.

Side screw mounting

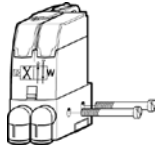

The brackets are then retracted.

Optional foot mounting



The brackets are then extended.

Valve pilot connections

1- Solenoid valve modules

Each solenoid presents an M8 connection. Lockable clip-on connectors, IP 67 protected, with LED, voltage surge protection and flying lead cable may be ordered for the required length. (Separate order on next page, or see page 28 for complete module order).

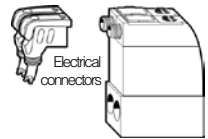

2- Air pilot valve modules

No connector has to be ordered : each pneumatic pilot port includes its integrated swivable elbow 4 mm OD tube push-in connector.

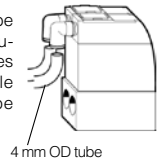

Modules and island ordering

Choice between 2 approaches :

1 - Basic modules ordering :

The following page shows these modules supplied without connector, together with the choice of clip-on connectors separately supplied (10 units packs). This approach gives the maximum flexibility.

2 - Complete modules ordering :

Page 28 shows the ordering chart for modules supplied with their pneumatic and electrical connectors and muffler.







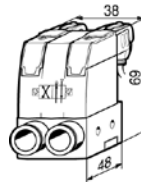

Valve module size 1





Valve module size 2



Basic modules (without connector)



Valve Modules		Size 1			Size 2		
Symbol	Description	Actuator	Weight (g)	Order code	Weight (g)	Order code	
 Size 1		4/2 Spring return	Solenoid Air pilot	72 67	P2M1S4ES2C P2M1S4PS	72 67	P2M2S4ES2C P2M2S4PS
		4/2 Double pilot	Solenoid Air pilot	87 77	P2M1S4EE2C P2M1S4PP	87 77	P2M2S4EE2C P2M2S4PP
		2 x 3/2 NC + NC with exhaust check valves	Solenoid Air pilot	85 75	P2M1SDEE2C P2M1SDPP	85 75	P2M2SDEE2C P2M2SDPP
 Size 2		2 x 3/2 NO + NO with exhaust check valves	Solenoid Air pilot	85 75	P2M1SCEE2C P2M1SCPP	85 75	P2M2SCEE2C P2M2SCPP
		2 x 3/2 NC + NO with exhaust check valves	Solenoid Air pilot	85 75	P2M1SEEE2C P2M1SEPP	85 75	P2M2SEEE2C P2M2SEPP
		3/2 NC with exhaust check valves	Solenoid Air pilot	85 75	P2M1S3ES2C P2M1S3PS	85 75	P2M2S3ES2C P2M2S3PS
		4/3 Centre exhaust 2 x 3/2 NC + NC with exhaust check valves	Solenoid Air pilot	85 75	P2M1SGEE2C P2M1SGPP	85 75	P2M2SGEE2C P2M2SGPP

Clip-On pneumatic connectors *

Valve Modules		Size 1			Size 2	
Description	Tube OD	Weight (g)	Order code	Weight (g)	Order code	
 Straight connector	G1/8"	2	FMDG1-1			
	4 mm	2	FMD04-1			
	6 mm	3	FMD06-1	3	FMD06-2	
	8 mm			4	FMD08-2	
	10 mm			5	FMD10-2	
 Elbow connector	G1/8"	3	CMDG1-1			
	4 mm	3	CMD04-1			
	6 mm	5	CMD06-1	5	CMD06-2	
	8 mm			6	CMD08-2	
	10 mm			7	CMD10-2	
 Silencer		3	MMDVA1	5	MMDVA2	
	Plug		3	PMDXX1	5	PMDXX2

* Fittings and plugs pack quantity : 10

Electrical connectors

Description	Connector type	Cable length	Weight (g)	Order code
 Clip-on individual electrical connector, for each solenoid pilot IP67 protected, including LED, voltage surge protection and flying lead cable	M8 / 2 x Flying leads	2 meters	62	P8LS08L226C
		5 meters	155	P8LS08L526C
		9 meters	180	P8LS08L926C
 Straight cable quick connect to thread connector, IP67 protected	M8		12	P8CS0803J
	M12		15	P8CS1204J

Peripheral Valve Modules : P series

Four additional peripheral modules complete the valve system in order to facilitate the installation of specific cylinder controls :

- Dual flow control, for cylinder speed adjusting;
- Dual pilot operated check valve, for cylinder positioning;
- Pressure regulator, for cylinder thrust adjusting;
- Vacuum generator, for vacuum pad controls.



Module function selection

Dual flow control

F By controlling the exhaust flows of a double acting cylinder, this module can adjust both speeds : forward and backward.

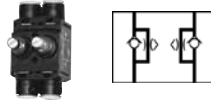

Dual pilot operated check valve

Combined with a double 3/2 NC + NC valve, this module will block flows and stop cylinder movement as soon as the valve outputs are both exhausted. Better than a 3 position closed centre valve, it provides accurate positioning when mounted close to the cylinder.

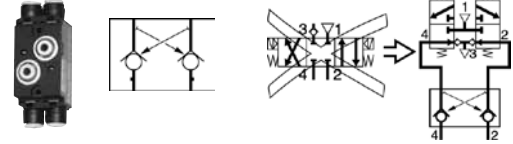

Pressure regulator

The thrust developed by a cylinder often requires adjustment by controlling the pressure to the front or back of the piston. This pressure regulator module enables manual adjustment of pressure on one side of the piston, with visual indication provided by the pressure gauge.

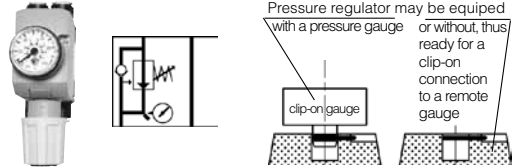

Vacuum generator

This multi-purpose module controls vacuum pads with a choice between two basics schematics :

- Controlled with only one 3/2 NC valve, the vacuum generator provides vacuum to the pads during valve actuation and then blow-off supplied from an integrated chamber.
- Controlled with a double 3/2 NC + NC, the vacuum generator provides vacuum during the first valve actuation, and then strong blow-off from the second valve.

Integrated blow-off flow controller. Optional plug-in vacuum sensor.

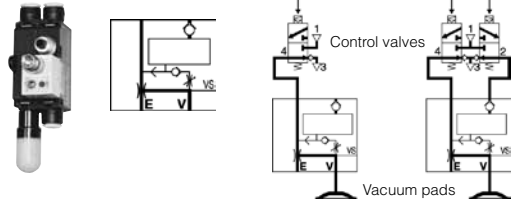

Module installation selection

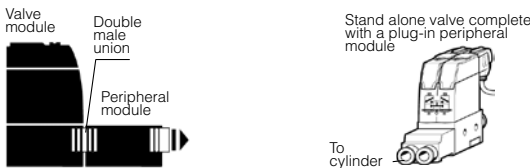





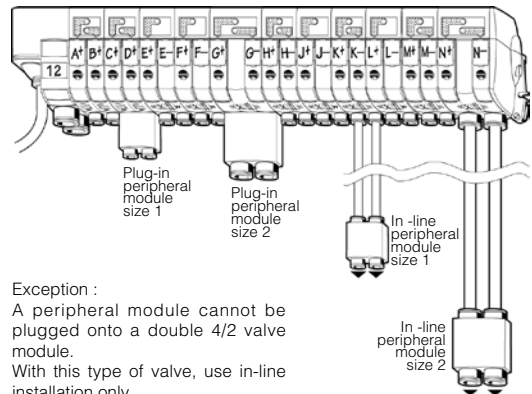



Peripheral modules may either be mounted :

- Plugged into the valve module through double male unions;
- Or in line, close to the cylinder to control it better.







Exception :
A peripheral module cannot be plugged onto a double 4/2 valve module.
With this type of valve, use in-line installation only.

Basic peripheral modules (without connector)



Peripheral Modules		Size 1		Size 2			
Symbol	Description	Weight (g)	Order code	Weight (g)	Order code		
	 Dual flow control	50	P2M1PXFA	50	P2M2PXFA		
	 Dual P.O. check valve	50	P2M1PXCA	50	P2M2PXCA		
	 Pressure regulator	Pressure range	Gauge				
		0 - 2 bar	0 - 4 bar	135	P2M1PXSR	135	P2M2PXSR
			Without	105	P2M1PXST	165	P2M2PXST
		0 - 4 bar	0 - 7 bar	135	P2M1PXSM	135	P2M2PXSM
			Without	105	P2M1PXSL	165	P2M2PXSL
	0 - 8 bar	0 - 11 bar	135	P2M1PXSG	135	P2M2PXSG	
		Without	105	P2M1PXSN	165	P2M2PXSN	
	 90% Vacuum generator	30	P2M1PXVA				

Clip-On pneumatic connectors *

Valve Modules		Size 1		Size 2	
Description	Tube OD	Weight (g)	Order code	Weight (g)	Order code
	G1/8"	2	FMDG1-1		
	4 mm	2	FMD04-1		
	6 mm	3	FMD06-1	3	FMD06-2
	8 mm			4	FMD08-2
	10 mm			5	FMD10-2
	12 mm			6	FMD12-2
	G1/8"	3	CMDG1-1		
	4 mm	3	CMD04-1		
	6 mm	5	CMD06-1	5	CMD06-2
	8 mm			6	CMD08-2
	10 mm			7	CMD10-2
	12 mm			8	CMD12-2
	Double male union	5	HMDXX1	8	HMDXX2
	Silencer	3	MMDVA1		
	Plug	3	PMDXX1	5	PMDXX2

* Fittings and plugs pack quantity : 10

Clip-on accessories

Description	Connection	Pressure range	Weight (g)	Order code
	Clip-on	0 to 4 bar	30	P2M1K0GT
		0 to 7 bar	30	P2M1K0GL
		0 to 11 bar	30	P2M1K0GN
	M8	0 to -1 bar	25	MPS-V6T-PC
Pressure sensors are equipped with an output LED and a switch point trimmer	Flying lead 2 meter cable	0 to -1 bar	25	MPS-V6T-PG

Complete module ordering, as compared to basic module ordering

Complete modules

Ordered from the following pages, the complete modules are supplied all equipped with their electrical and pneumatic connectors. Only one order line is necessary, and each module comes complete, with just the necessary chosen connectors.



Basic modules

Ordered from the previous pages, the basic modules are to be equipped with their connectors. There clip-on assembly to the module is easy. The main advantage is flexibility : connector type and size may be chosen at the last moment, to fit better the machine needs.



V series

See opposite page for complete module order code chart

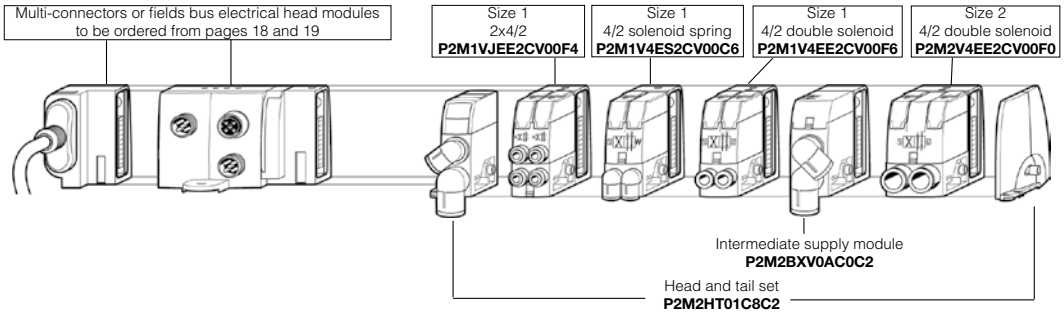

T series

See opposite page for complete module order code chart

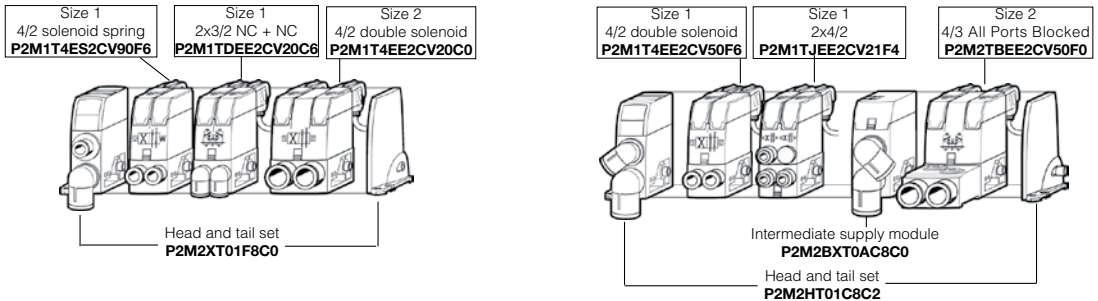

Special case : the 2 x 4/2 mini-module plug configuration

For micro-cylinders, this very compact 2 x 4/2 module (order code JEE) may also be used to obtain 3/2 valves, either Normally Closed or Normally Open. To do so, the complete module may be supplied with plugs that may replace some of the plug-in connectors. To order, use the top chart from opposite page.

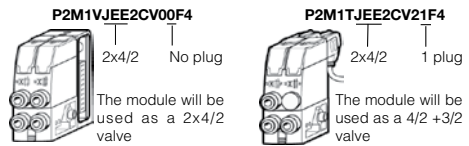

S and P series

See page 28 and 29 for complete module order code charts.

Complete Moduflex modules, equipped with their electrical and pneumatic connectors, may be ordered. To do so, use the below chart to define the complete module order codes.

Valve modules



Minimum ordering quantity : 10 pieces

1 2 3 4 5 6 7 8 9 10 11 12 13 14 15

P 2 M 1 V 4 E E 2 C V 0 0 F 6

Size	<table border="1" style="width: 100%; border-collapse: collapse;"> <tr><td>1</td><td>Size 1</td></tr> <tr><td>2</td><td>Size 2</td></tr> </table>	1	Size 1	2	Size 2	Series	<table border="1" style="width: 100%; border-collapse: collapse;"> <tr><td>V</td><td>Integrated connections</td></tr> <tr><td>T</td><td>Individual connectors</td></tr> </table>	V	Integrated connections	T	Individual connectors	Electrical connections	<table border="1" style="width: 100%; border-collapse: collapse;"> <tr><td colspan="2">V Series</td></tr> <tr><td>V0</td><td>Integrated connection</td></tr> <tr><td colspan="2">T Series</td></tr> <tr><td>00</td><td>No cable</td></tr> <tr><td>V2</td><td>2 m cable</td></tr> <tr><td>V5</td><td>5 m cable</td></tr> <tr><td>V9</td><td>9 m cable</td></tr> </table>	V Series		V0	Integrated connection	T Series		00	No cable	V2	2 m cable	V5	5 m cable	V9	9 m cable	Pneumatic connectors Ports 2 & 4	<table border="1" style="width: 100%; border-collapse: collapse;"> <tr><td colspan="2">Size 1 modules</td></tr> <tr><td>F4</td><td>Straight 4 mm OD</td></tr> <tr><td>C4</td><td>Elbow 4 mm OD</td></tr> <tr><td>F6</td><td>Straight 6 mm OD</td></tr> <tr><td>C6</td><td>Elbow 6 mm OD</td></tr> <tr><td colspan="2">Size 2 modules</td></tr> <tr><td>F6</td><td>Straight 6 mm OD</td></tr> <tr><td>C6</td><td>Elbow 6 mm OD</td></tr> <tr><td>F8</td><td>Straight 8 mm OD</td></tr> <tr><td>C8</td><td>Elbow 8 mm OD</td></tr> <tr><td>F0</td><td>Straight 10 mm OD</td></tr> <tr><td>C0</td><td>Elbow 10 mm OD</td></tr> </table>	Size 1 modules		F4	Straight 4 mm OD	C4	Elbow 4 mm OD	F6	Straight 6 mm OD	C6	Elbow 6 mm OD	Size 2 modules		F6	Straight 6 mm OD	C6	Elbow 6 mm OD	F8	Straight 8 mm OD	C8	Elbow 8 mm OD	F0	Straight 10 mm OD	C0	Elbow 10 mm OD
1	Size 1																																																				
2	Size 2																																																				
V	Integrated connections																																																				
T	Individual connectors																																																				
V Series																																																					
V0	Integrated connection																																																				
T Series																																																					
00	No cable																																																				
V2	2 m cable																																																				
V5	5 m cable																																																				
V9	9 m cable																																																				
Size 1 modules																																																					
F4	Straight 4 mm OD																																																				
C4	Elbow 4 mm OD																																																				
F6	Straight 6 mm OD																																																				
C6	Elbow 6 mm OD																																																				
Size 2 modules																																																					
F6	Straight 6 mm OD																																																				
C6	Elbow 6 mm OD																																																				
F8	Straight 8 mm OD																																																				
C8	Elbow 8 mm OD																																																				
F0	Straight 10 mm OD																																																				
C0	Elbow 10 mm OD																																																				
Valve Function - Solenoid Versions *				Plug configurations																																																	
<table border="1" style="width: 100%; border-collapse: collapse;"> <tr><td>4 ES</td><td>4/2 Solenoid spring</td></tr> <tr><td>4 EE</td><td>4/2 Double solenoid</td></tr> <tr><td>D EE</td><td>2 x 3/2NC + NC (with exhaust check valve)</td></tr> <tr><td>C EE</td><td>2 x 3/2 NO + NO (with exhaust check valve)</td></tr> <tr><td>E EE</td><td>2 x 3/2 NC + NO (with exhaust check valve)</td></tr> <tr><td>3 ES</td><td>3/2 NC (with exhaust check valve)</td></tr> <tr><td>G EE</td><td>4/3 centre exhaust (= 2x3/2 without exhaust check valve)</td></tr> <tr><td>B EE</td><td>2x3/2 + clipped dual PO check (= 4/3 APB)</td></tr> </table>				4 ES	4/2 Solenoid spring			4 EE	4/2 Double solenoid	D EE	2 x 3/2NC + NC (with exhaust check valve)	C EE	2 x 3/2 NO + NO (with exhaust check valve)	E EE	2 x 3/2 NC + NO (with exhaust check valve)	3 ES	3/2 NC (with exhaust check valve)	G EE	4/3 centre exhaust (= 2x3/2 without exhaust check valve)	B EE	2x3/2 + clipped dual PO check (= 4/3 APB)	<table border="1" style="width: 100%; border-collapse: collapse;"> <tr><td>0</td><td>No plug</td></tr> </table>		0	No plug																												
4 ES	4/2 Solenoid spring																																																				
4 EE	4/2 Double solenoid																																																				
D EE	2 x 3/2NC + NC (with exhaust check valve)																																																				
C EE	2 x 3/2 NO + NO (with exhaust check valve)																																																				
E EE	2 x 3/2 NC + NO (with exhaust check valve)																																																				
3 ES	3/2 NC (with exhaust check valve)																																																				
G EE	4/3 centre exhaust (= 2x3/2 without exhaust check valve)																																																				
B EE	2x3/2 + clipped dual PO check (= 4/3 APB)																																																				
0	No plug																																																				
Size 1 only	J EE	2x4/2 with exhaust check valve with plug configuration	Only for JEE 2x4/2 modules (1)																																																		
				<table border="1" style="width: 100%; border-collapse: collapse;"> <tr><td>0</td><td>0 plug (2x 4/2)</td></tr> <tr><td>1</td><td>1 plug (4/2 + 3/2)</td></tr> <tr><td>2</td><td>2 plugs (2x3/2 or 1x4/2)</td></tr> <tr><td>3</td><td>3 plugs (1x3/2)</td></tr> </table>		0	0 plug (2x 4/2)	1	1 plug (4/2 + 3/2)	2	2 plugs (2x3/2 or 1x4/2)	3	3 plugs (1x3/2)																																								
0	0 plug (2x 4/2)																																																				
1	1 plug (4/2 + 3/2)																																																				
2	2 plugs (2x3/2 or 1x4/2)																																																				
3	3 plugs (1x3/2)																																																				



* For T series only, air pilot versions p21, as basic modules.

Head/Tail & Intermediate Modules

Minimum ordering quantity : 10 pieces

1 2 3 4 5 6 7 8 9 10 11 12 13

P 2 M 2 H X T 0 1 F 0 C 2

	HXT01	V and T series Pneumatic head and tail set	Pressure port connector	Exhaust port connector
	BXV0A	V series intermediate supply module with a set of 4 configuration plates	F6 Straight 6 mm OD	F6 Straight 6 mm OD
	BXT0A	T series intermediate supply module with a set of 4 configuration plates	C6 Elbow 6 mm OD	C6 Elbow 6 mm OD
			F8 Straight 8 mm OD	F8 Straight 8 mm OD
			C8 Elbow 8 mm OD	C8 Elbow 8 mm OD
			F0 Straight 10 mm OD	F0 Straight 10 mm OD
			C0 Elbow 10 mm OD	C0 Elbow 10 mm OD
			F2 Straight 12 mm OD	F2 Straight 12 mm OD
			C2 Elbow 12 mm OD	C2 Elbow 12 mm OD
			PP Plug	PP Plug
			MM Muffler	MM Muffler

Complete Moduflex stand alone valves, equipped with their electrical and pneumatic connectors, may be ordered. To do so, use the below chart to define the complete module order codes.

Stand alone valve modules



1	2	3	4	5	6	7	8	9	10	11	12	13	14	15
P	2	M	1	S	4	E	E	2	C	V	5	A	F	6

Minimum ordering quantity : 10 pieces

Size	
1	Size 1
2	Size 2

Series	
S	Stand alone valve modules

Electrical connector	
00	No cable
V2	2 m cable
V5	5 m cable
V9	9 m cable

Valve Function - Solenoid Versions *	
4 ES	4/2 Solenoid spring
4 EE	4/2 Double solenoid
D EE	2 x 3/2 NC + NC (with exhaust check valve)
C EE	2 x 3/2 NO + NO (with exhaust check valve)
E EE	2 x 3/2 NC + NO (with exhaust check valve)
3 ES	3/2 NC (with exhaust check valve)
G EE	4/3 centre exhaust (= 2x3/2 without exhaust check valve)
B EE	2x3/2 + clipped dual PO check (= 4/3 APB)

Pneumatic connectors					
Ports 1 & 3		Outlet ports 2 & 4		Tube OD	
A	Straight & straight	F	Straight & straight	Size 1 modules	
B	Elbow & elbow	C	Elbow & elbow		
C	Straight & muffler	0	No connector for plug-in P module	4	4 mm OD
D	Elbow & muffler			6	6 mm OD
				8	8 mm OD
				10	10 mm OD

* Air pilot version, p23, as basic modules.

Size 1
4/2 solenoid spring
P2M1S4ES2CV5CC6



Size 1
2x3/2 NC + NC
P2M1SDEE2CV2BC6



Size 2
4/2 double solenoid
P2M2S4EE2CV9CC8



Size 2
2x3/2 NC + NC
P2M2SDEE2CV2CC0



Size 2
4/3 All Ports Blocked
P2M2SBEE2CV2AF0

Complete Moduflex peripheral module, equipped with their pneumatic connectors, may be ordered. To do so, use the below chart to define the complete module order codes.

Dual flow control, dual pilot operated check valve, and pressure regulator peripheral modules

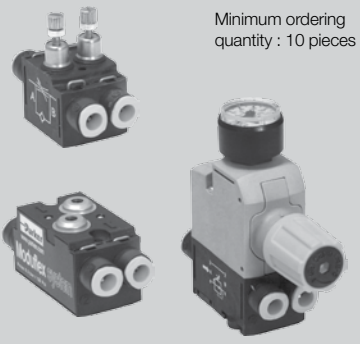

Minimum ordering quantity : 10 pieces

1 2 3 4 5 6 7 8 9 10 11 12

P 2 M 1 P X F A J J F 6

Size	
1	Size 1
2	Size 2

Peripheral module function	
F A	Dual flow control
C A	Dual P.O. check valve
Pressure regulators	
S R	0-2 bar, with pressure gauge
S M	0-4 bar, with pressure gauge
S G	0-8 bar, with pressure gauge

Inlet port pneumatic connectors	
Size 1 modules	
F4	Straight 4 mm OD
C4	Elbow 4 mm OD
F6	Straight 6 mm OD
C6	Elbow 6 mm OD
Size 2 modules	
F6	Straight 6 mm OD
C6	Elbow 6 mm OD
F8	Straight 8 mm OD
C8	Elbow 8 mm OD
F0	Straight 10 mm OD
C0	Elbow 10 mm OD

Outlet port pneumatic connectors	
Size 1 modules	
F4	Straight 4 mm OD
C4	Elbow 4 mm OD
F6	Straight 6 mm OD
C6	Elbow 6 mm OD
Size 2 modules	
F6	Straight 6 mm OD
C6	Elbow 6 mm OD
F8	Straight 8 mm OD
C8	Elbow 8 mm OD
F0	Straight 10 mm OD
C0	Elbow 10 mm OD

F

Vacuum generator peripheral module



Minimum ordering quantity : 10 pieces

1 2 3 4 5 6 7 8 9 10 11 12 13 14 15 16

P 2 M 1 P X V A F 6 A F 6 C M A

Size	
1	Size 1

Peripheral module function	
V A	Vacuum generator

Vacuum connectors and vacuum sensors (2) *	
F4 Straight 4 mm OD	A 2 push-in connectors
C4 Elbow 4 mm OD	
F6 Straight 6 mm OD	B 1 push-in connector + 1 plug on blow-off port
C6 Elbow 6 mm OD	
JJ Clip-on double male	

Vacuum connectors and vacuum sensors (2) *	
F4 Straight 4 mm OD	A 2 push-in connectors
C4 Elbow 4 mm OD	
F6 Straight 6 mm OD	B 1 push-in connector + 1 plug
C6 Elbow 6 mm OD	
F1 Straight threaded 1/8"	C 1 push-in connector + 1 vacuum sensor MPS-V6T-PC
C1 Elbow threaded 1/8"	

Exhaust port (3) *	
F4	Straight 4 mm OD
C4	Elbow 4 mm OD
F6	Straight 6 mm OD
C6	Elbow 6 mm OD
MA	Clip-on muffler

Moduflex Valve Island Configurator

This software facilitates any valve island configuration and its bill ordering through basic or complete modules.

Pre-assembled valve island ordering

As an option, so defined with the configurator, any Moduflex Valve island may be ordered as pre-assembled.



F Island configuration practice

An easy step by step procedure, finalized with the complete valve island print, composition report and 2D drawing.

Valve island modules identification

Valve island graphic description

including pneumatic function module symbol, outlet port connector, pneumatic and electrical head module,...

Additional peripheral modules

Valve island composition

including each module description and order code

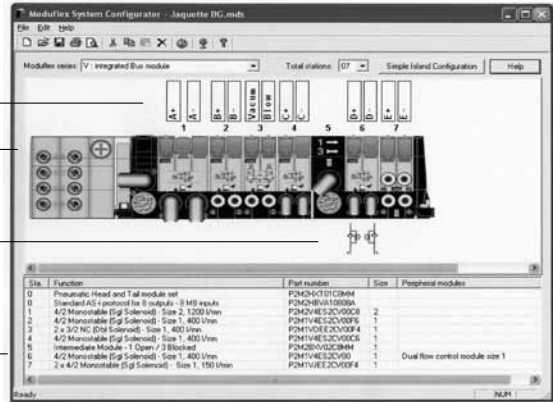

An easy to use software for a complete ordering tool

The Moduflex Valve Island Configurator software offers an easy way to, step by step, configure the required valve island for the application.

Valve island print with symbols and markings

Once the valve island configured, picture of the configuration allows a visual control.

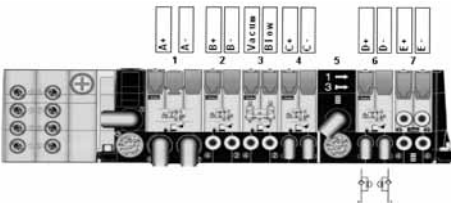

2D drawing :

A direct valve island configuration exportation function to .dxf format included.

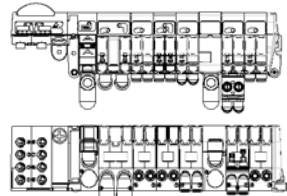

3D drawing library :

3 formats are available on the CD for each basic module, electrical components and pneumatic connectors.

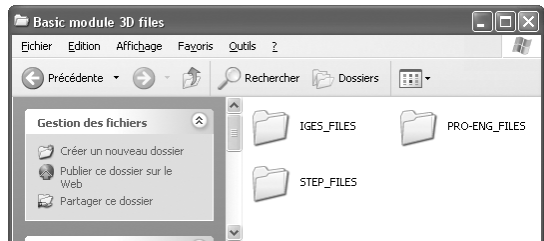

4 pages report :

A complete 4 pages report can be edit, giving :

Page 1	Page 2	Page 3	Page 4
Complete list of "basic modules" pneumatic connectors, mufflers and electrical connectors	Complete list of components splitted slice by slice	Detail list of "complete module" with module width and total valve island length	Warnings and advices depending on the configuration

Multi-language CD-Rom order code :

PDE2536CDV3.1-ev

3D e-configurator software :

Also available, a 3D e-configurator on : <http://www.parker.com/pneu/moduflex>

Maintenance procedure

The latest generations of compact pneumatic valves have a life expectancy which generally exceeds the equipment they control. Therefore, although maintenance is seldom

required, when necessary the solenoid pilot, valve or connector can be easily replaced without removing the island base, as shown below.

S and T series

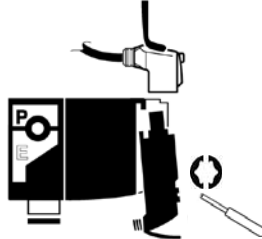
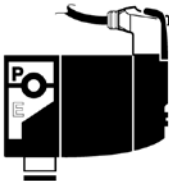

V series

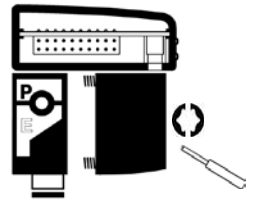
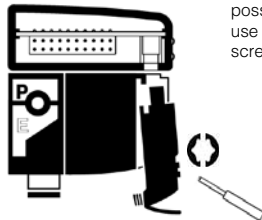

Please, use a Torx T8 screw driver. Also possible to use a 3.5 mm screwdriver.

F

With only one universal solenoid pilot for all configurations, maintenance is simple

24V DC is now a global standard for all machines.

The Moduflex 24V DC unique solenoid pilot is supplied with the multi-function manual override that can be adapted to all requirements, as explained by the drawings.

Because all Moduflex valve and island configurations are supplied with this unique solenoid pilot, maintenance operations remain very simple.

For more informations : chap. 9, manual section.

Multi-function adaptable manual override

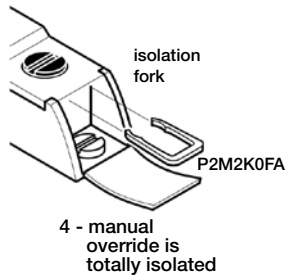
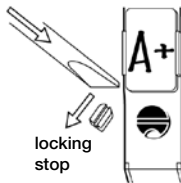
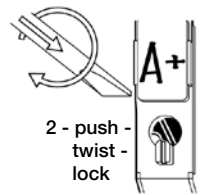
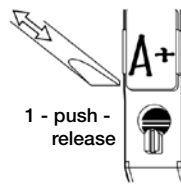



Maintenance components

valve module solenoid pilot 24 V DC		Weight (g)	Order code
 P2D8V32C5	solenoid pilot (without plug-in electrical connector)	15	P2D8V32C5
	Pneumatic pilot (with 4 mm OD tubing push-in elbow fitting)	10	P2M2K0PA

size 1 valve modules without solenoid pilot and without sub-base		Weight (g)	Order code
 P2M1X4EE	4/2 monostable	26	P2M1X4ES
	4/2 bistable	25	P2M1X4EE
3/2	double NC + NC	28	P2M1XDEE
	double NO + NO	28	P2M1XCEE
	double NC + NO	28	P2M1XEES
	single NC	25	P2M1X3ES
4/3 CE	double 3/2 NC + NC without exhaust check valve	28	P2M1XGEE

size 2 valve modules without solenoid pilot and without sub-base		Weight (g)	Order code
 P2M2X4EE	4/2 monostable	28	P2M2X4ES
	4/2 bistable	30	P2M2X4EE
3/2	double NC + NC	32	P2M2XDEE
	double NO + NO	32	P2M2XCEE
	double NC + NO	32	P2M2XEES
	single NC	28	P2M2X3ES
4/3 CE	double 3/2 NC + NC without exhaust check valve	32	P2M2XGEE

Device bus electrical head module

Description	Bus In / Bus Out connector type	Power supply connector type	Bus communication module adaptor	Weight (g)	Order code
 With adaptor	M12 - B coding	M12 - A coding	With	250	P2M2HBVP1600
	M12 - B coding	M12 - A coding	Without	210	P2M2HBVP01600
 Without adaptor	M12 - A coding	M12 - B coding	With	250	P2M2HBVD1600
	M12 - A coding	M12 - B coding	Without	210	P2M2HBVD01600
CANopen head module	M12 - A coding	M12 - B coding	With	250	P2M2HBVC1600
	M12 - A coding	M12 - B coding	Without	210	P2M2HBVC01600
Bus communication module adaptor				30	P2M2HEV0B

For EDS & GSD files, go to <http://www.parker.com/pneu/moduflex>

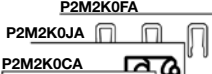
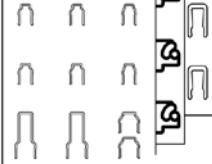
Set of maintenance parts		Weight (g)	Order code	
 P2M2K0FA	Clips	set of 10 clips : 6 for size 1 modules, 2 for size 2 modules, 2 for island head and intermediate module	6	P2M2K0CA
	Seals	set of 10 seals : 3 inter island base seals, 3 under solenoid pilot seals, 4 under valve seals (2 size 1 seal, 2 size 2 seals)	6	P2M2K0JA
 P2M2K0CA	Forks	set of 10 isolation forks for solenoid pilot manual override	8	P2M2K0FA

Island head module port sizing

Moduflex is totally flexible : islands may have up to 19 valves, with a choice of 2 valve sizes, depending on the required flow. Thus, each island has specific needs for the size of its pressure supply and its exhaust collection.

Choice of connections to an island P and E ports

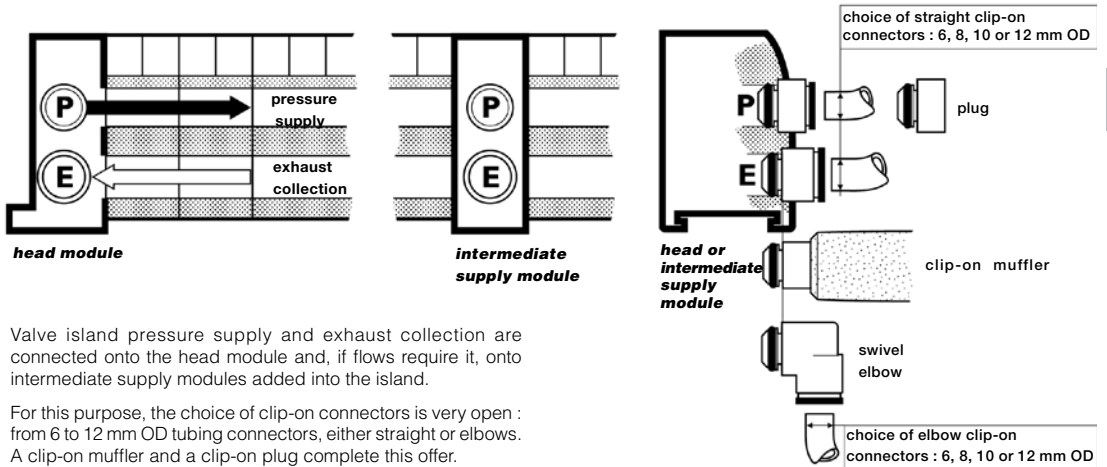

F

Valve island pressure supply and exhaust collection are connected onto the head module and, if flows require it, onto intermediate supply modules added into the island.

For this purpose, the choice of clip-on connectors is very open : from 6 to 12 mm OD tubing connectors, either straight or elbows. A clip-on muffler and a clip-on plug complete this offer.

Sizing recommendations

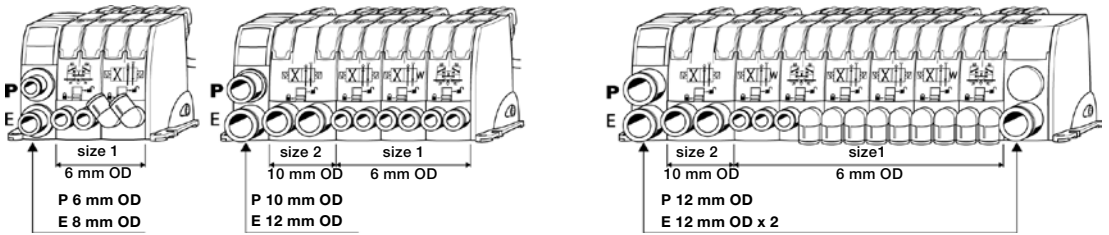

The 3 valve islands above present typical situations for sizing islands pressure supply and exhaust collection.

In a given island, valves do not deliver their flow at the same moment. Thus, the number of valves in an island is not the major factor to consider. More important is the size of the largest valve and of the largest output tubes to the cylinders.

We would recommend the following :

- air supply connection at least equivalent to largest output tube to cylinders ;
- exhaust collection at least twice the section area of the largest output tube to cylinders.

For islands with high flows, the following options are possible :

- use tubes up to 12 mm OD or mufflers providing exhaust collection is not necessary ;
- provide additional P and/or E connection ports by inclusion of intermediate supply modules, thus keeping tube size small.

At the machine commissioning stage, the supply and exhaust connections can be easily modified until the required performance is achieved.

ID section areas of standard tubings		
2 x 4 mm : 3 mm ²	5.5 x 8 mm : 24 mm ²	10 x 12 mm : 80 mm ²
2.7 x 4 mm : 6 mm ²	6 x 8 mm : 28 mm ²	
4 x 6 mm : 12 mm ²	7 x 10 mm : 40 mm ²	muffler : 100 mm ²
	8 x 10 mm : 50 mm ²	equivalent

Recommendations for building machines with imperial OD tubes (US usual standard)

size 1 modules

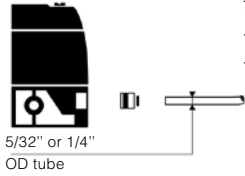

Moduflex being a global product is available in the US with the two standards that are commonly used in this country :

- metric OD tubes with the metric connectors shown in this catalog,
- imperial OD tubes with specific connectors for the US.

Machine builders exporting to the US may propose to their clients one of the following solutions.

- Machines equipped with Moduflex components connected with metric tubes found in this catalog. Parker will provide products locally for maintenance.
- Or machines equipped with Moduflex components connected with imperial size OD tubes. In this case, use the following procedure to order Moduflex and to build the machine.

size 2 modules

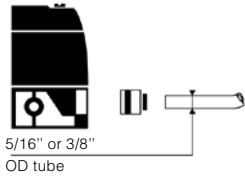

Imperial OD tube and metric OD tube comparison

metric standard tube OD	imperial US standard tube OD	metric equivalent	Moduflex clip-on connectors
4 mm	5/32"	4 mm	imperial and metric connectors identical
6 mm	1/4"	6,35 mm	specific imperial connector
8 mm	5/16"	8 mm	imperial and metric connectors identical
10 mm	3/8"	9,53 mm	specific imperial connector
12 mm	1/2"	12,7 mm	specific imperial connector

head and intermediate island modules

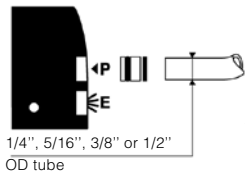

Moduflex selection for imperial size OD tubes

Such components will easily be obtained with the following procedure :

- 1 - Select the required basic modules (with no connector).
- 2 - Select from the list below the clip-on connectors for the required imperial OD tubes.
- 3 - Push-in the connectors into the basic modules ports in order to obtain complete modules.



pneumatic connectors for size 1 modules

	Pack Quant.	<i>elbow version</i>		<i>straight version</i>	
		Weight (g) per unit	Order code	Weight (g) per unit	Order code
clip-on tube push-in connector	10	5	CMD04-1	2	FMD04-1
	10	5	CMD07-1	3	FMD07-1



pneumatic connectors for size 2 modules head and intermediate island modules

	Pack Quant.	<i>elbow version</i>		<i>straight version</i>	
		Weight (g) per unit	Order code	Weight (g) per unit	Order code
clip-on tube push-in connector	10	5	CMD07-2	3	FMD07-2
	10	6	CMD08-2	4	FMD08-2
	10	7	CMD09-2	5	FMD09-2
	10	8	CMD13-2	6	FMD13-2

1 - Multi-connector or sub-D 25 valve island

Multi-connector or sub-D 25 electrical head module width : 48 mm width : 15 mm

Head and tail pneumatic module set width : 48 mm

Modules size 1 width : 25 mm

Modules size 2 width : 37.5 mm

Intermediate module width : 25 mm

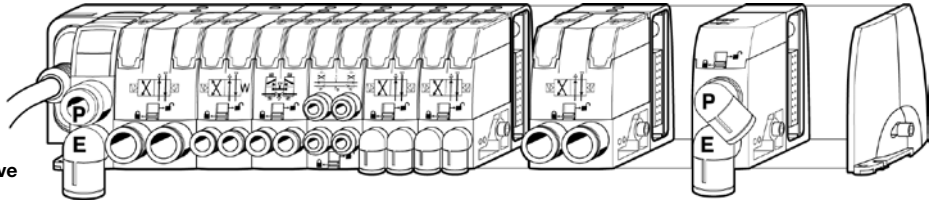

Island total width depending on valve composition

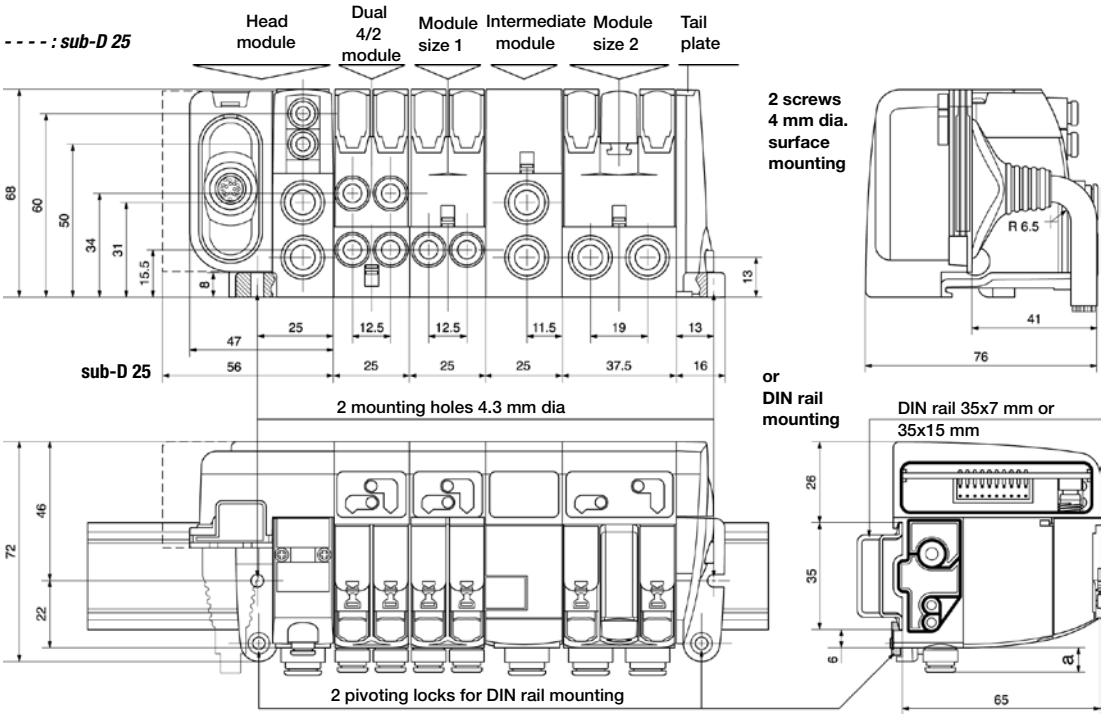

Special case : 4/3 closed centre function within island version : Add the dimensions of the dual P.O. check valve module plugged into the island. See pages 39 and 40 for dimensions.

Island head and intermediate modules

	a	b	c
6 mm tube OD	8	13	16
8 mm tube OD	9	16	19
10 mm tube OD	13	18	22
12 mm tube OD	13	19	25
muffler		40	

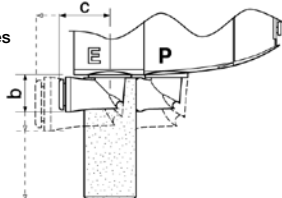

Island valves modules

	OD tube	a	b	c
Size 1 modules	4 mm	8	10	12
	6 mm	8	13	16
Size 2 modules	8 mm	9	16	19
	10 mm	13	18	22

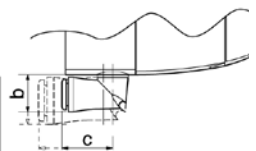

2 - Field bus connected islands

Electrical field bus head module width : 62 mm	Head and tail pneumatic module set width : 48 mm	Modules size 1 width : 25 mm	Modules size 2 width : 37.5 mm	Intermediate module width : 25 mm
---	---	---------------------------------	-----------------------------------	--------------------------------------

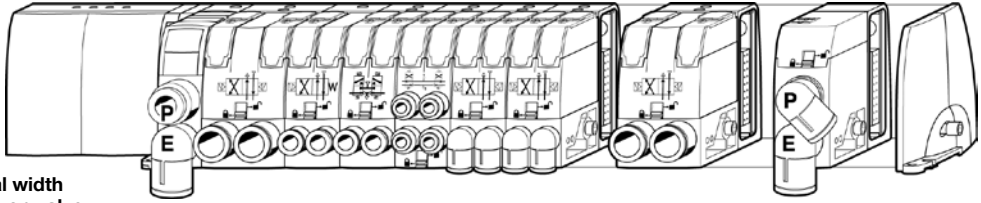

Island total width depending on valve composition

F

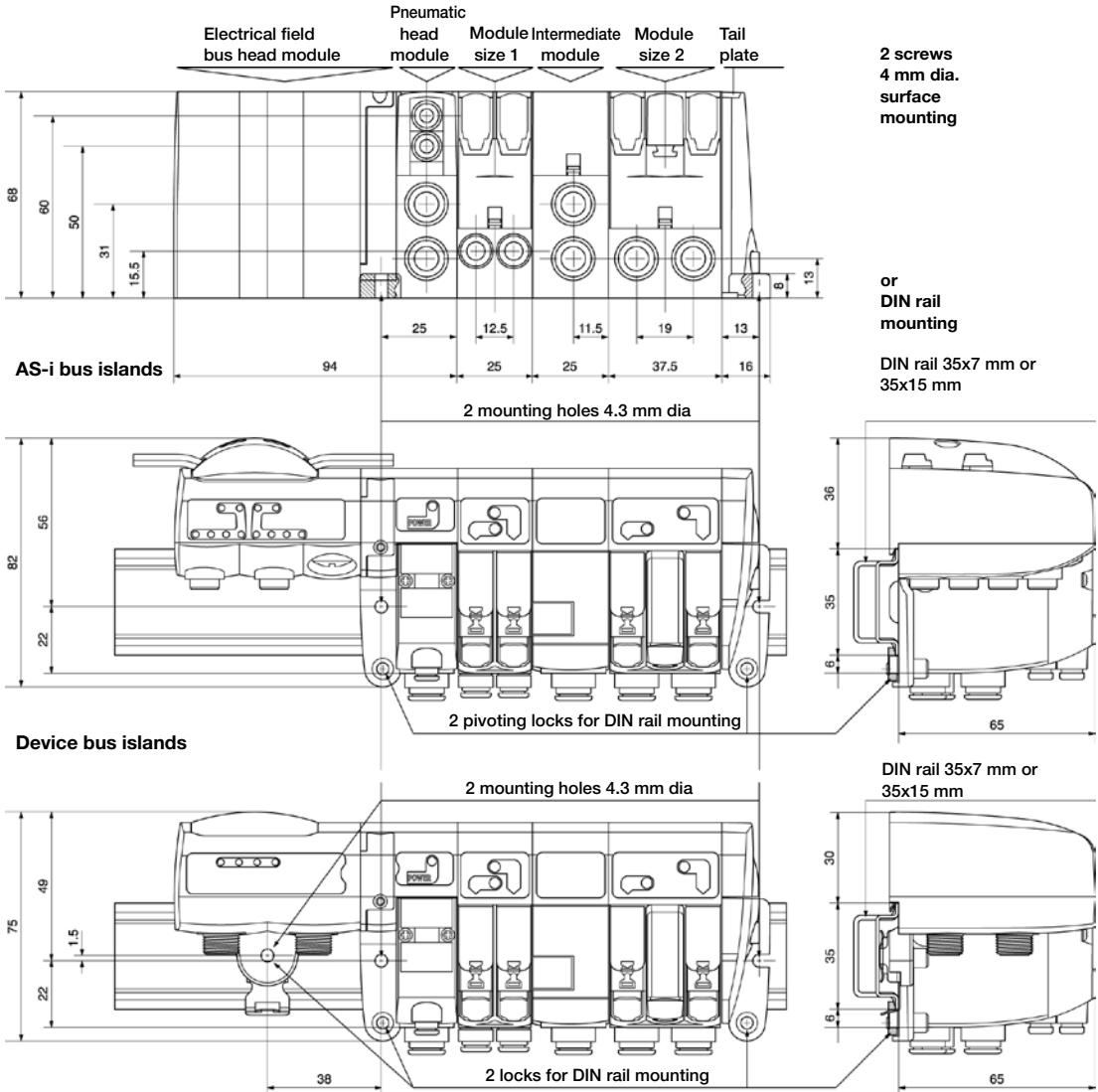

Island total width depending on valve composition

Pneumatic head and tail module width → 48 mm
 Modules size 1 25 mm
 Modules size 2 37.5 mm
 Intermediate module 25 mm

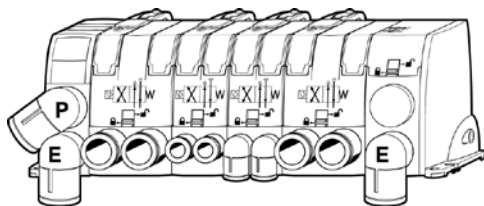
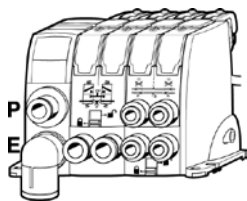

F

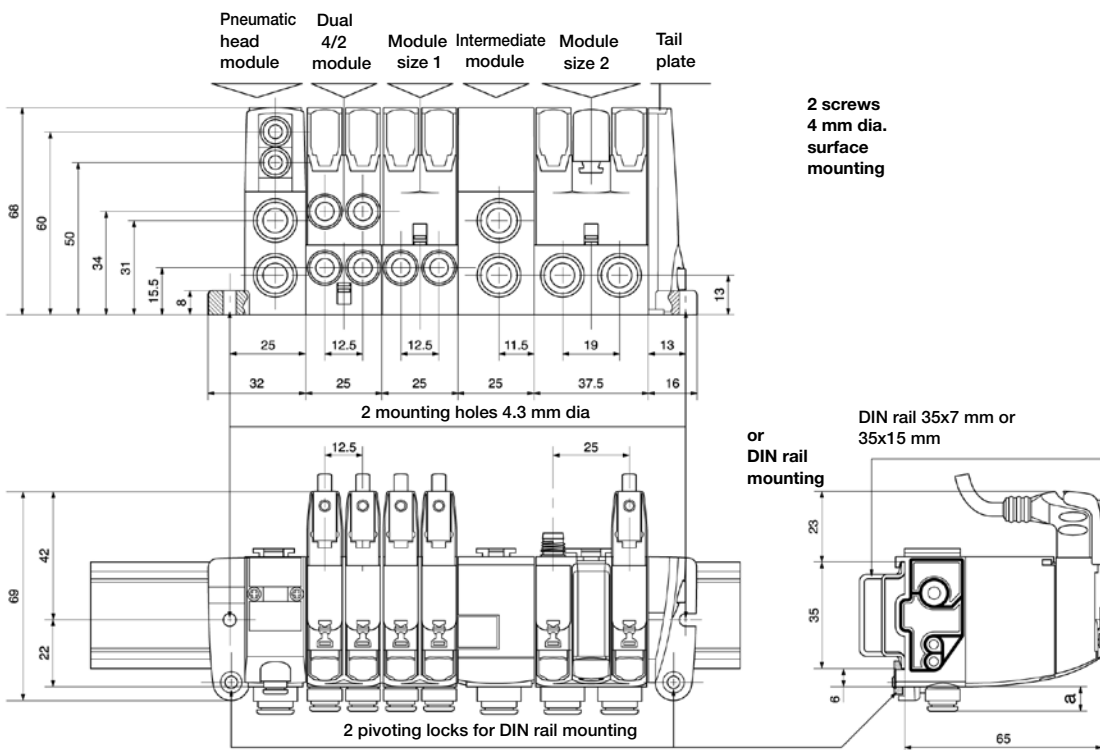

Special case : 4/3 closed centre function within island version :
 Add the dimensions of the dual P.O. check valve module plugged into the island.

Island head and intermediate modules

	a	b	c
6 mm tube OD	8	13	16
8 mm tube OD	9	16	19
10 mm tube OD	13	18	22
12 mm tube OD	13	19	25
muffler		40	

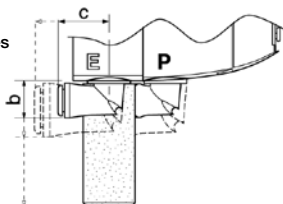

Island valves modules

	OD tube	a	b	c
Size 1 modules	4 mm	8	10	12
	6 mm	8	13	16
Size 2 modules	8 mm	9	16	19
	10 mm	13	18	22

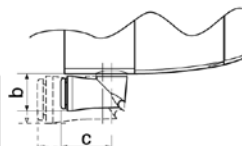

Stand-alone valve size 1



surface mounting with screws
4 mm dia. into retractable brackets 3 mm thick

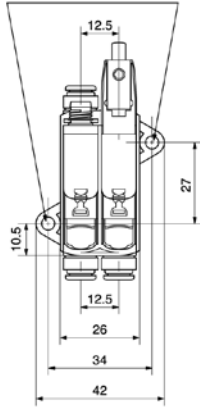

or side mounting with
2 screws 4 mm dia.

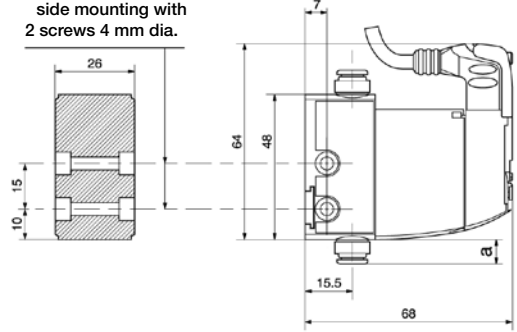

Stand-alone valve size 2



surface mounting with screws
4 mm dia. into retractable brackets 3 mm thick

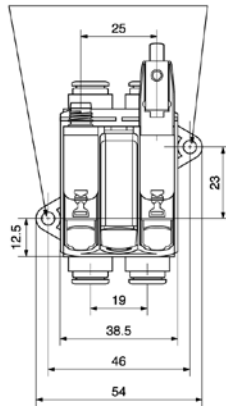

or side mounting with
2 screws 4 mm dia.

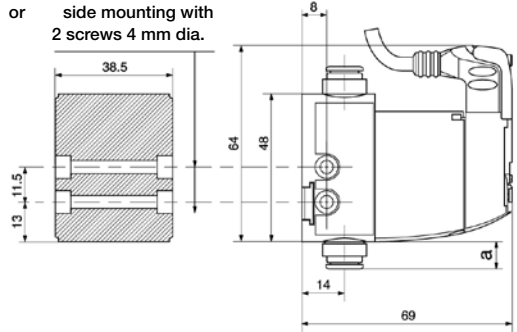

Dimensions and mountings of the stand-alone valves 4/2, double and single 3/2, 4/3 vented centre and 4/3 pressure centre.

Special case : 4/3 closed centre.
Add the dual P.O. check valve module that has been plugged in the basic valve.

		a	b	c
Size 1 modules	4 mm tube OD	8	10	12
	6 mm tube OD	8	13	16
	muffler		31	
Size 2 modules	8 mm tube OD	9	16	19
	10 mm tube OD	13	18	22
	muffler		40	

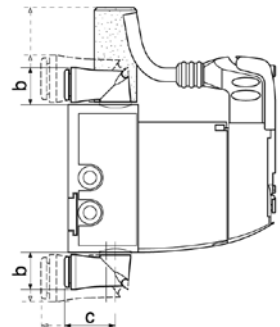

Reminder : peripheral modules may either be plugged in a valve output ports or mounted in line separate from the valve



Dual flow control module size 1

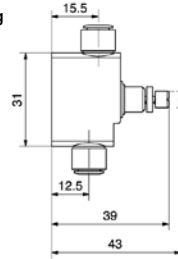
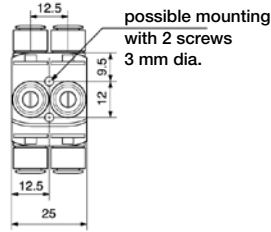
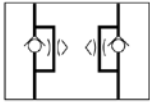

Pressure regulation module size 1

mounting with 2 screws 4 mm dia. on retractable brackets

- with gauge

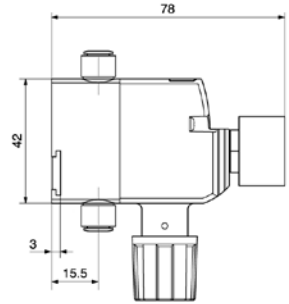
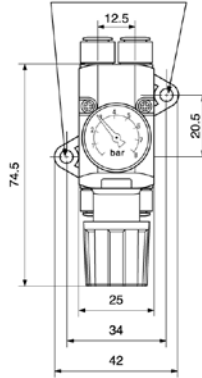
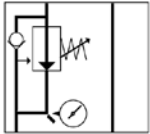

- without gauge

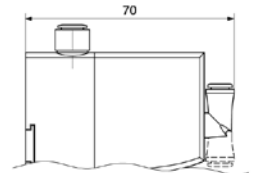
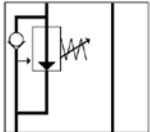

Dual P.O. check valve module size 1

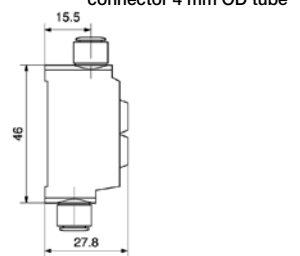
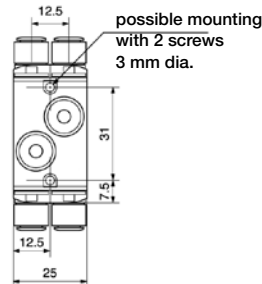
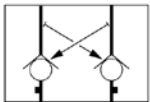

F

Dual flow control module size 2

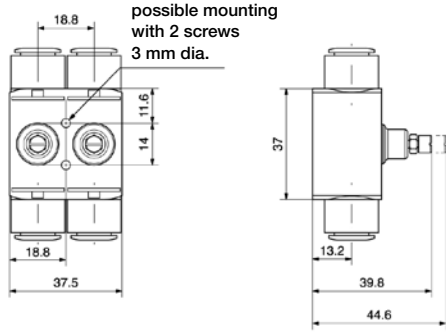
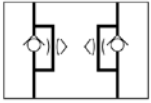

F

Pressure regulation module size 2

- with gauge

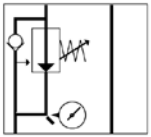

mounting with 2 screws 4 mm dia. on retractable brackets

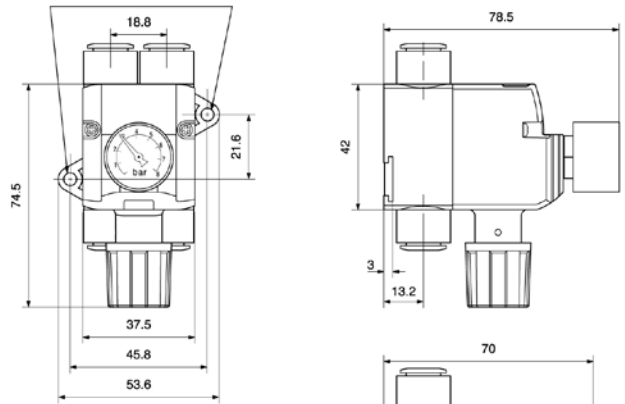

- without gauge

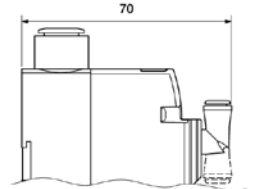
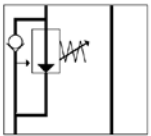

swivel elbow push-in connector 4 mm OD tube

Dual P.O. check valve module size 2

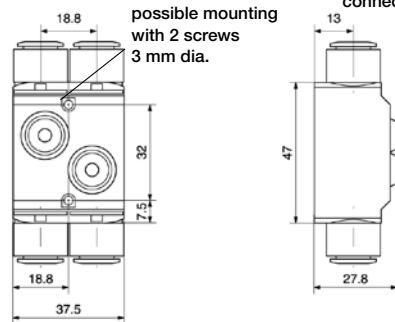
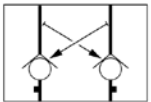

Vacuum generator module
In-line

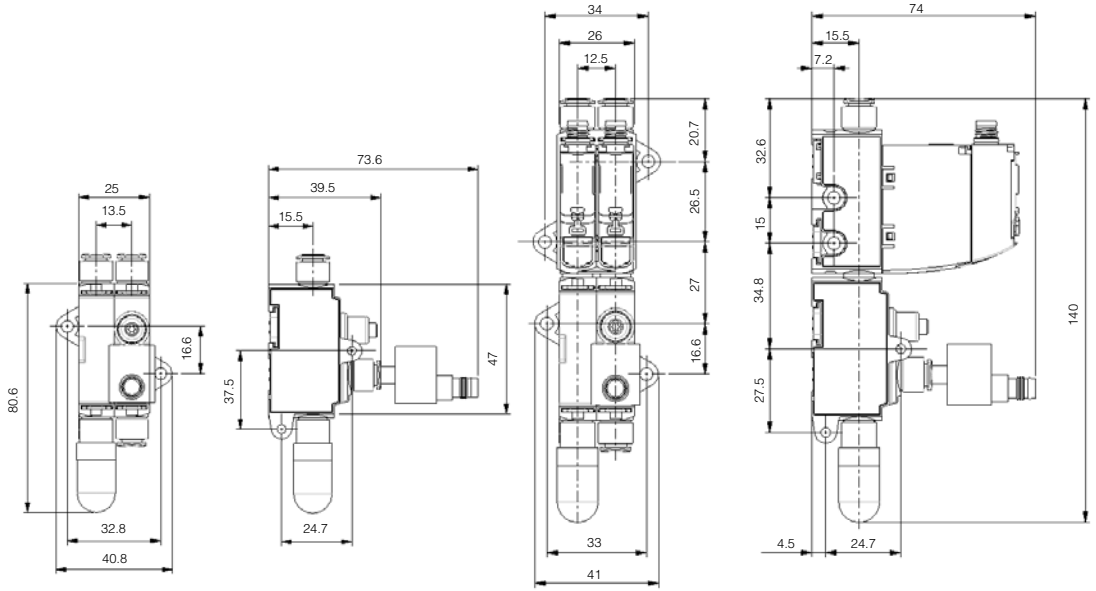

F

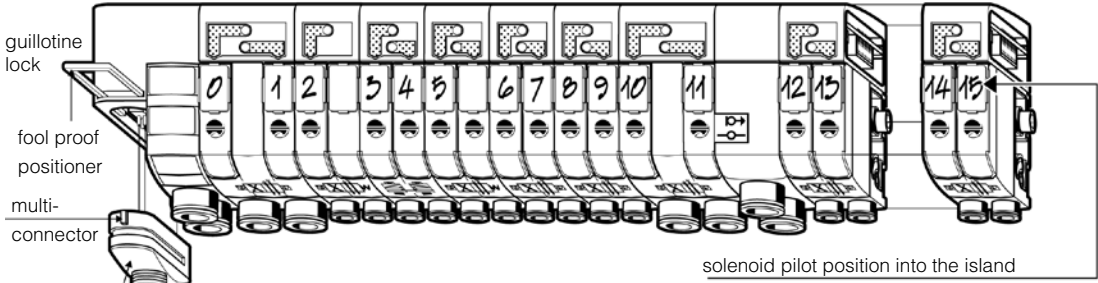

F

The valve island head multi-connector

On the island head module, the multi-connector integrates the HE10 connector standard in its 20 pin version. Its plug-in function is secured in position with a guillotine lock with easy access from the front of the island. Just like the whole island, the multi-connector follows the IP 65 protection standard.

Cable specification :

8,6 mm dia., UL, 20 wires, 0.22 mm², AWG 24.

Minimum static radius : 6.5 mm.

Available with 2 m, 5 m and 9 m lengths.

Multi-connector addressing

When assembling a V series island, modules are automatically connected to the head module through the modular principle of the integrated electrical connections, as explained on chap. 8 of the manual.

The color code addressing given below conforms to the DIN 47100 standard.

To each wire color code corresponds a solenoid pilot position in the island.

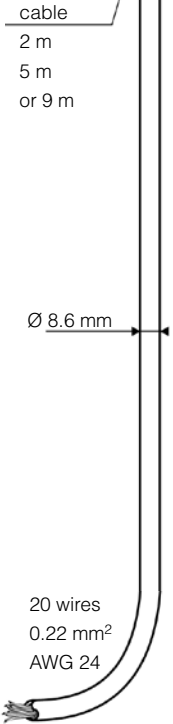

solenoid pilot position into the island		
color code	color code	color code
0 pink - brown	7 white - green	14 grey
1 white - pink	8 red - blue	15 yellow
2 grey - brown	9 grey - pink	16 green
3 white - grey	10 violet	17 brown
4 yellow - brown	11 red	18 white
5 white - yellow	12 blue	
6 brown - green	13 pink	common : black

Sub-D 25 addressing

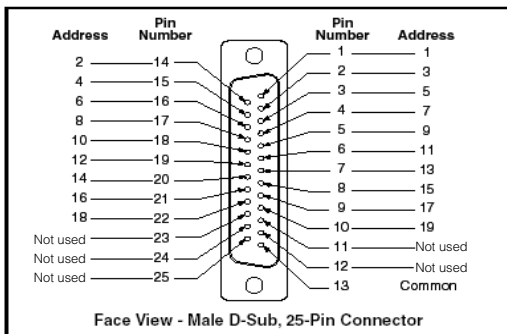
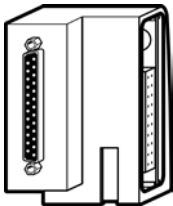

Bus addressing, first and second node

Address the first node in the first step.
Profil :

ID Code	AS-IV2.0	AS-IV2.1
ID	7	7
ID1	F	A
ID2	F	E

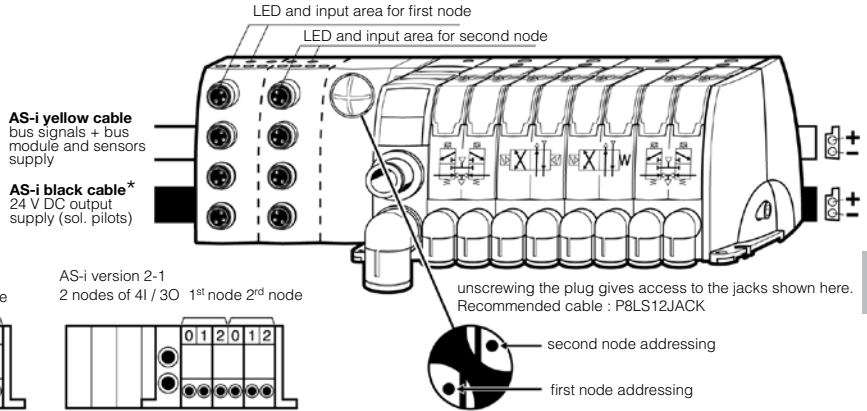

AS-i standard
2 nodes of 4I / 4O 1st node 2nd node

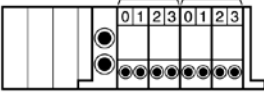

AS-i version 2-1
2 nodes of 4I / 3O 1st node 2nd node

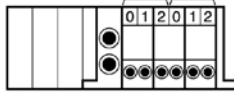

* The external supply shall have protective isolation in accordance with IEC 364-4-41 (PELV).

Bus diagnostic

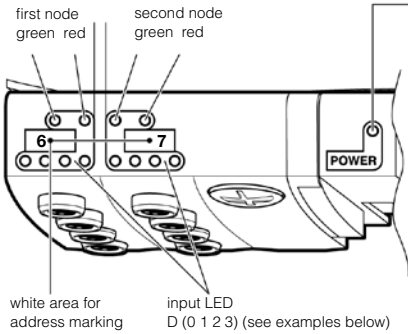

«power» LED state	off	green	red
Power supply	sol. pilot supply	normal operation	solenoid overload

first node LEDs state		second node LEDs state		System condition
green LED	red LED	green LED	red LED	
●	○	●	○	Normal operation
○	○	○	○	No module + sensor supply
○	⊙	○	⊙	Input overload
○	●	○	⊙	No AS-i communication
⊙	●	○	⊙	Address first node = 0
●	○	⊙	●	Address second node = 0

● ON ○ OFF ⊙ BLINK

Input wiring

Physical input (I, II, III, IV) = D (0 1 2 3) first node,
Examples : physical input III = logical input 6.2,

physical input (V, VI, VII, VIII) = D (0 1 2 3) second node
physical input V = logical input 7.0

M8 female connectors

pin out

- 1 - 24 V DC / AS-i
- 3 - 0 V DC / AS-i
- 4 - input

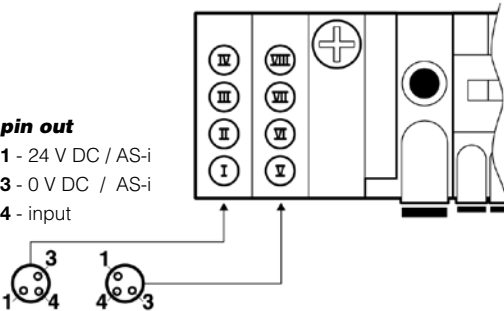

M12 female connectors

pin out

- 1 - 24 V DC / AS-i
- 2 - second input
- 3 - 0 V DC / AS-i
- 4 - first input
- 5 - not connected

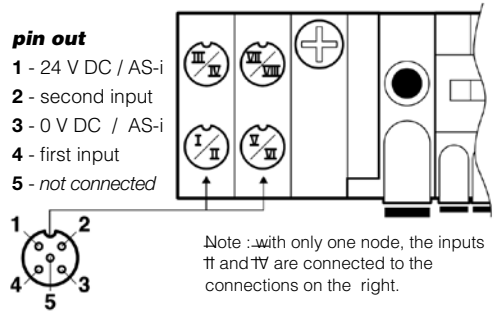

Note : with only one node, the inputs II and IV are connected to the connections on the right.

Power supply common to all types of device bus modules

1 - Connection

All bus modules have a M12 male connector for power supply.

M12 supply

connector (as seen on module)

M12
type A

- 1 - 24 V DC module (not connected for DeviceNet and CANopen)
- 2 - not connected
- 3 - 0 V DC module and solenoid
- 4 - 24 V DC solenoid
- 5 - protected earth (PE)

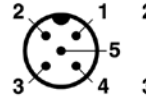

2 - Diagnostic

The two «power» indicators shown on the illustrations provide visual indication of the module and solenoid supply status.

Note : output power to the solenoids can be wired to allow the user to turn the outputs off while allowing the communications to remain on.

— green : power module OK green : power solenoid OK

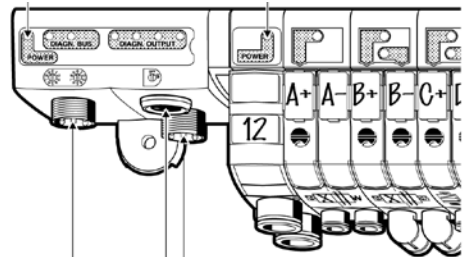

«bus in» and «bus out» connectors

Bus cable protection shield connections for Profibus DP, DeviceNet and CANopen

To provide protection against electro-magnetic interferences, the bus cables are shielded. The module «bus in» and «bus out» connectors each includes a pin for connecting the cable shield (see next pages). It is safer to connect the shield to the protected earth (PE) at both ends of the bus. Within the bus module, provision is made to enable shield continuity by connection between the two shield pins.

The protected earth have to be connected locally on each module for CE accordance.

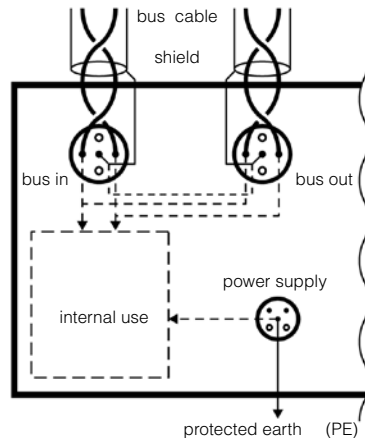



Bus cable connections

Profibus DP standard male and female type B M12 connectors.
 Use of prefabricated cables available from your usual electrical supplier is recommended.
 Line termination, P8BPA00MB, is necessary on the «bus out» connector of the last station.

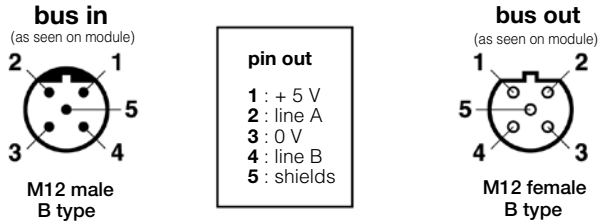

Addressing

Use the .GSD file on Moduflex web site : <http://www.parker.com/pneu/Moduflex>
 The coding wheels enable configuration of the decimal address.

Diagnostic

Diagnostic according to the module dialog shown on the illustration.

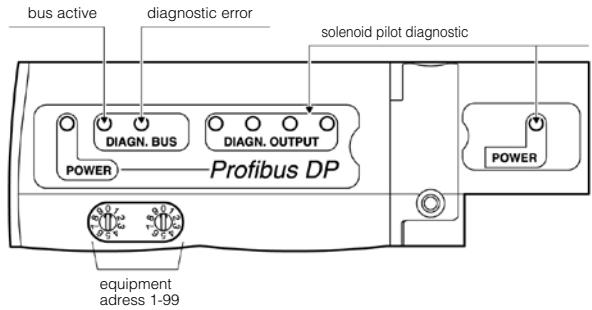

F



Bus cable connections

DeviceNet standard male and female type A M12 connectors.
 The alimentation for the module is supplied from the V+ and V- (24 V DC) of «bus in» connector.
 Use of prefabricated cables available from your usual electrical supplier is recommended.
 Line termination, P8BPA00MA, is necessary on the «bus out» connector of the last station.

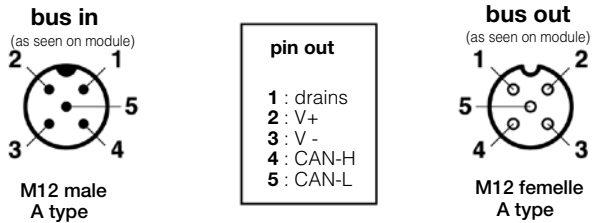

Addressing

Use the .EDS file on Moduflex web site : <http://www.parker.com/pneu/Moduflex>
 The coding wheels enable configuration of the decimal address.

Diagnostic

Diagnostic according to the module dialog shown on the illustration.

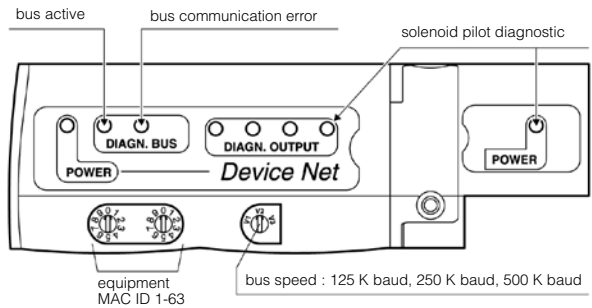

CANopen

Bus cable connections

CANopen standard male and female type A M12 connectors. The alimentation for the module is supplied from the V+ and V- (24 V DC) of «bus in» connector. Use of prefabricated cables available from your usual electrical supplier is recommended. Line termination, P8BPA00MA, is necessary on the «bus out» connector of the last station.

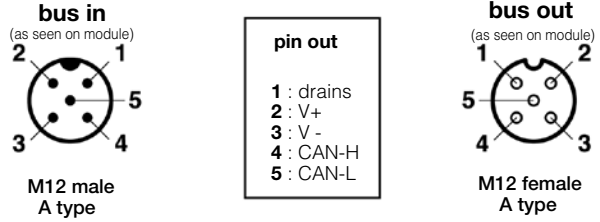

Addressing

Use the .EDS file on Moduflex web site : <http://www.parker.com/pneu/Moduflex>
The coding wheels enable configuration of the decimal address.

Diagnostic

Diagnostic according to the module dialog shown on the illustration.

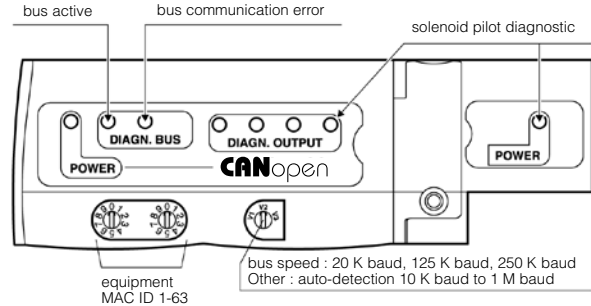

Compatibility



Intégration of P2M2 head modules in SRB Advantys

The P2M2HBVC11600 CANopen head modules are integrated in the inputs/ outputs Telemecanique Advantys STB whatever bus chosen for the installation.

7 types of communication bus Advantys STB are available (Ethernet, CAN Open, FIP I/O, Profibus DP, DeviceNet, InterbusS, Modbus+).

These head modules P2M2 are integrated in the Advantys STB SPU 1xxxx catalogue software. Just use "drag and drop" to use the application.

It is possible to connect up to 12 head modules P2M2 on the same island Advantys STB.

Addressing head modules P2M2 is automaticcally managed by the Advantys STB island.

The P2M2 head module diagnostic will be included into the Advantys STB island diagnostic.

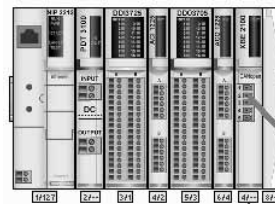

Parker Moduflex valve system p2m2hbcvc11600 : 16 outputs

INTERBUS-S

Bus cable connections

The M23 connectors conform to «Interbus remote bus».

Use of prefabricated cables available from your electrical usual supplier is recommended.

Automatic Addressing

InterBus-S is self addressing. Thus it does not need any software or hardware configuration.

Manual Addressing

InterBus-S network can also be manually configured using :

- ID code : 03 (hexadecimal)
- Data length : 2 bytes

Diagnostic

Diagnostic according to the module dialog shown on the illustration.
 This diagnostic conforms to the InterBus-S standard.

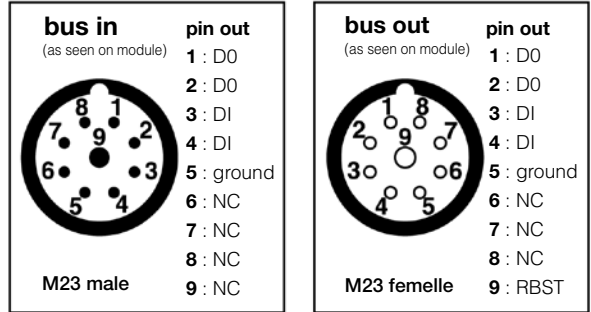

Note : for more details please consult «Interbus remote bus» documentation

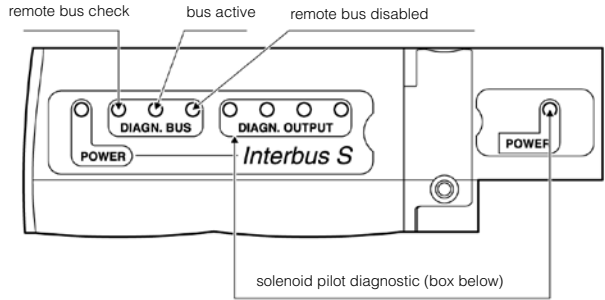

Solenoid pilot diagnostic common to all device bus modules

Red LEDs detecting solenoid valve short-circuits

A : sol. pilots 0 to 3 B : sol. pilots 4 to 7 C : sol. pilots 8 to 11 D : sol. pilots 12 to 15

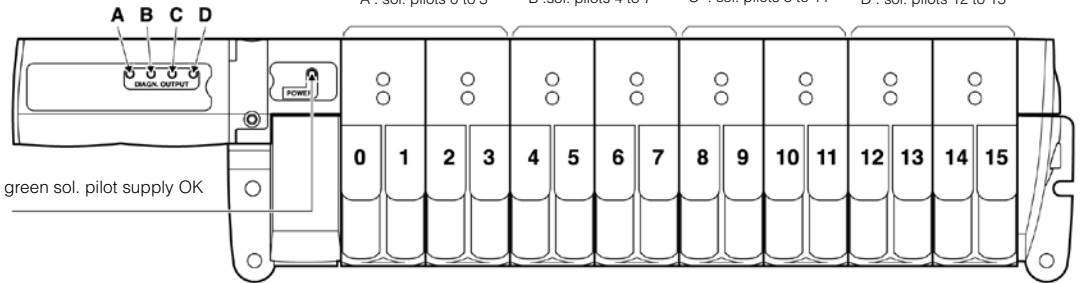

Inside the bus module, solenoid valve control is protected against short-circuits, with the following visual indication provided :

- The solenoid pilot power supply indicator, green when supply is OK.
- The red LEDs detecting solenoid valve short-circuits with code shown above.

F

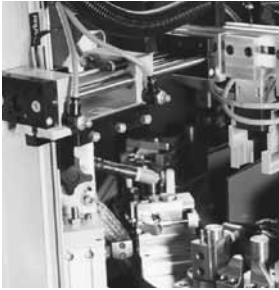

Valvetronic Valves

Complete modularity and simplicity

Valvetronic

Valvetronic is a global concept, including mechanical, electrical, and electronic technology, which enables the connection of a group of pneumatic valves to a control system by means of either a multiwire cable or a bus.

Valvetronic Solstar

- Configurations 3/2 NC and 3/2 NO
- Flow max 50NI/min

Valvetronic PVLC10

- Configurations 2 x 3/2, 5/2, 5/3
- Flow max 1800NI/min

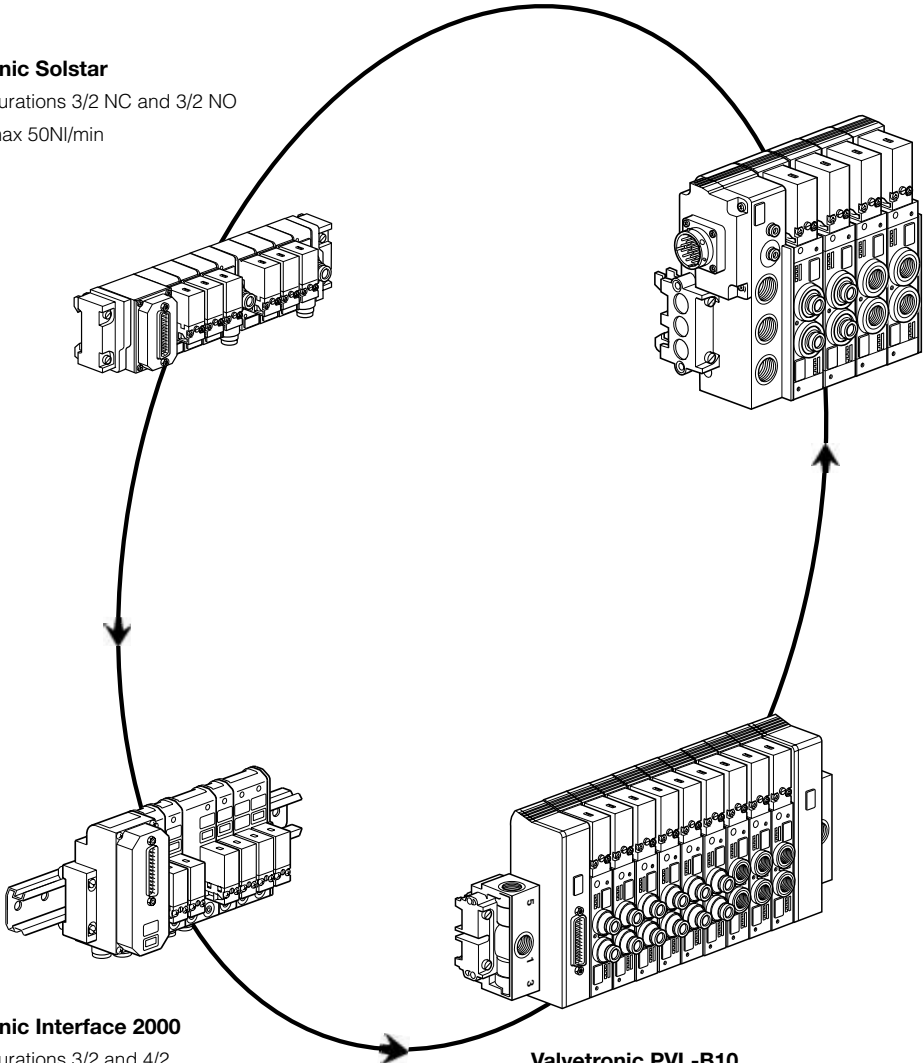

Valvetronic Interface 2000

- Configurations 3/2 and 4/2
- Flow max 200NI/min

Valvetronic PVL-B10

- Configurations 2 x 3/2, 5/2, 5/3
- Flow max 900NI/min

Valvetronic[®] is a registered trademark of Parker Hannifin S.A.

Conventional solution
Multiple connection by individual wires

Use of a screw terminal block in the PLC enclosure and on the machine in order to wire all the electrical connections.

The fitter has to use terminal blocks for the link between all the common

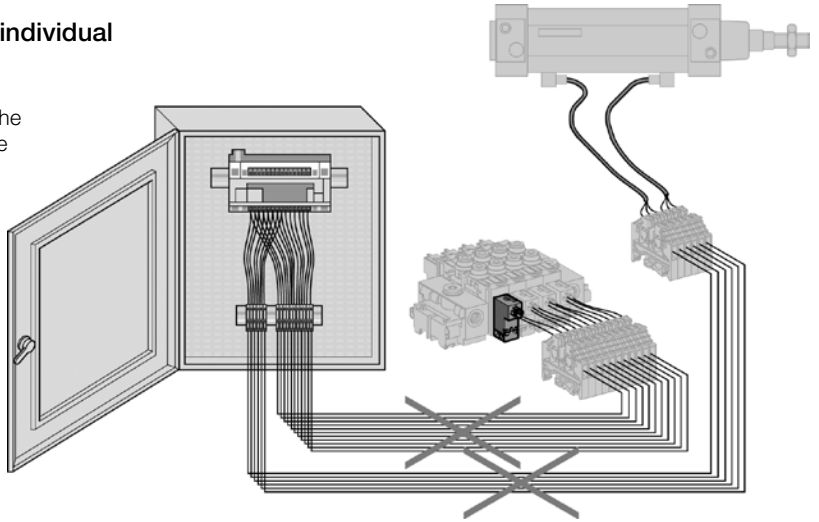

G

Valvetronic solution
wires.

Parallel wiring connection with centralised connector

Direct connection to the PLC, of a remote input or output device or on a special terminal block, with a multiwire cable.

All electrical commons are prewired in the valve

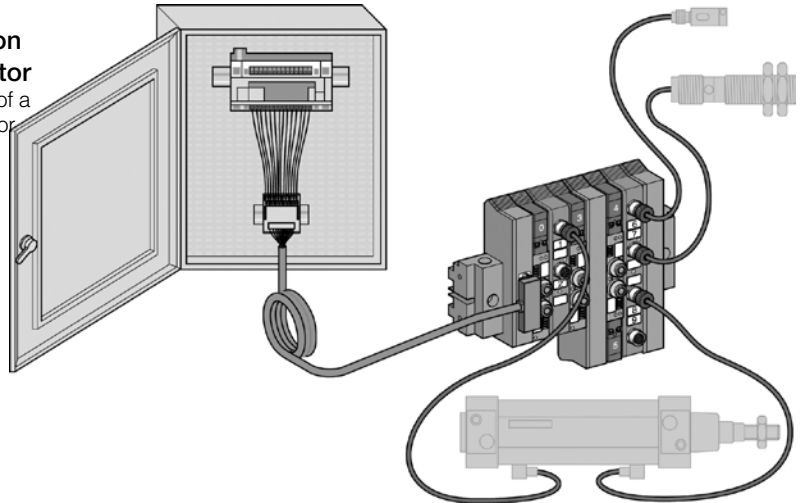

Valvetronic solution
configuration.

Bus connection

The connection may be further simplified by the use of bus. In this case, all the electrical information (Inputs and/ or Outputs) are coded on the wires of the physical layer of the bus.

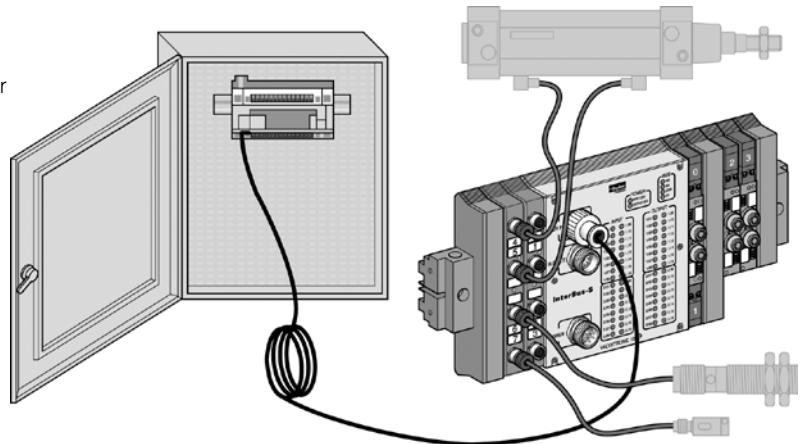

Should I use Parallel Wiring or a Bus?

All processes whether continuous or repetitive require mechanical and systematic controls. Communication between these two disciplines is essential. Traditionally, this has been made by electric cables connecting each device, which would have meant 2 or 3 connections to control each action.

The more complex the control system becomes the more expensive the wiring becomes, documentation, identification, elimination of errors through testing, all add to the expense. Modification and extension to the wiring is difficult if not impossible which adds greatly to the overall cost of the control system.

The purpose of parallel wiring or bus is to simplify the connection between the controller and each device.

Field of application of parallel wiring and bus

Using parallel wiring with valve islands would be ideal for the smaller application where the close proximity of the valve island and sensors can be maintained.

Bus is more suitable where several valve islands and many devices are connected, typically over greater distances, additional automation products such as machine diagnostics, speed drivers, analogue sensors etc. can also be included.

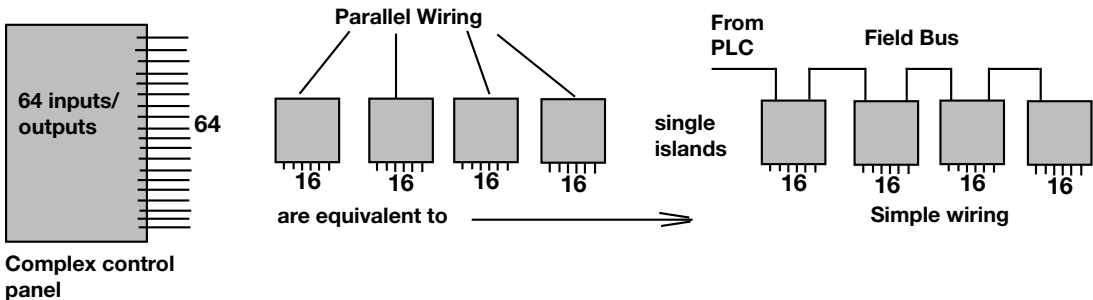

Conclusion

Manufacturers of automation equipment supply a whole range of input/output modules which communicate via a field bus with the control system.

Our solution is based on an electropneumatic valve island which is able to communicate with these bus systems.

The major advantages are reduced and easier wiring from the valves to the input/output modules generating a cost saving to the end user.

Which bus to choose ?

The need to communicate is not new in the work place, and local networks directly derived from the data processing network system have become more common place in industrial applications.

But needs vary considerably. Functions implemented vary from supervision where a response time in the order of a second is acceptable, to remote control (job

coordination) where a tenth of a second is sufficient and complex data acquisition for which a response time requirement of real time (10 ms) is indispensable.

The information transmitted also varies: from file transfer or supervision commands, variables and commands for job control, numerical variables, to analog or binary for data acquisition.

Bus hierarchy

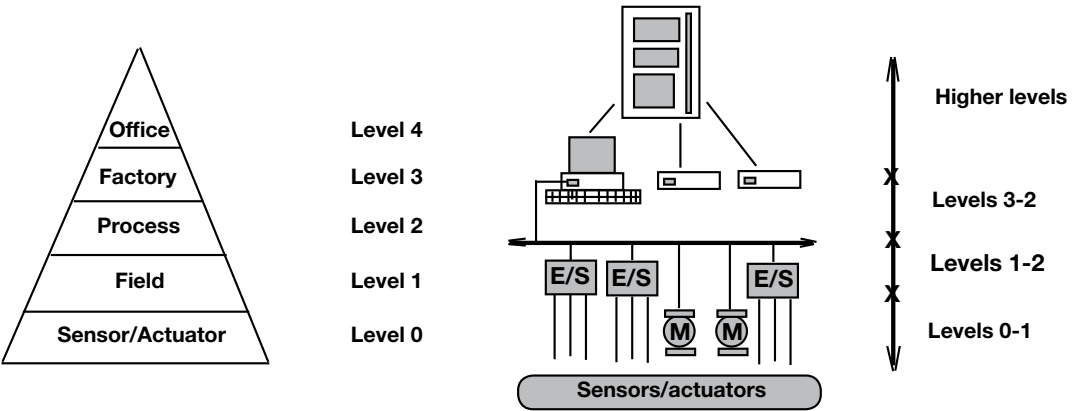

Supervisory level: messages, remote loading, production information, management, sequence supervision, alarms

Level 2-3 coordination of sequences and operations, supervision of system status (operation mode, fault indicator)

Level 1-2 determination of the total status of the automated system at any instant

Level 0-1 monitoring of a single discrete or continuous variable.

Three main categories of bus meet different needs, with regards to installation, data transmission and response times:

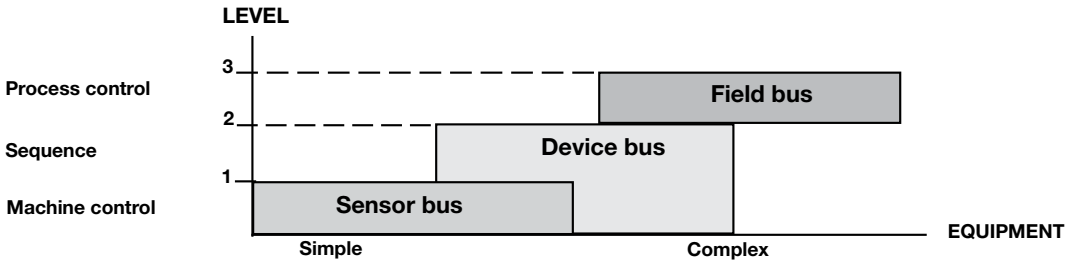

Field bus - For process control

- Function: coordination, remote loading, supervision etc.
- Nominal response time: 50 ms to 1 s
- Data exchange: $\geq k$ bytes
- Distance: ≥ 1 km
- Equipment connected: workstations, PC, PLC, numerically controlled equipment, intelligent peripherals ...
- Examples: Profibus FMS, World Fip, Fipway.

Device bus - For sequence

- Function: connection of intelligent I/O modules
- Nominal response time: 10 to 50 ms
- I/O: 4096 I/O (32 to 256 per node)
- Distance: less than 1 km
- Equipment connected: automatic equipment, connection boxes, machinery, variable speed controllers, intelligent sensors
- Examples: Device Net, CAN, FIPIO, Profibus DP, Interbus S, SDS.

Sensor bus - For machine control

- Function: local connection of sensors and actuators.
- Nominal response time: 5 to 10 ms
- I/O: 256 I/O (8 per node)
- Distance: less than 100 m
- Equipment connected: PLC, sensors, actuators, connection boxes.
- Examples: ASI, Sensor loop, CANopen, Lon Works.

Typical application of Valvetronic with device bus : several groups of I/O within less than 1 km.

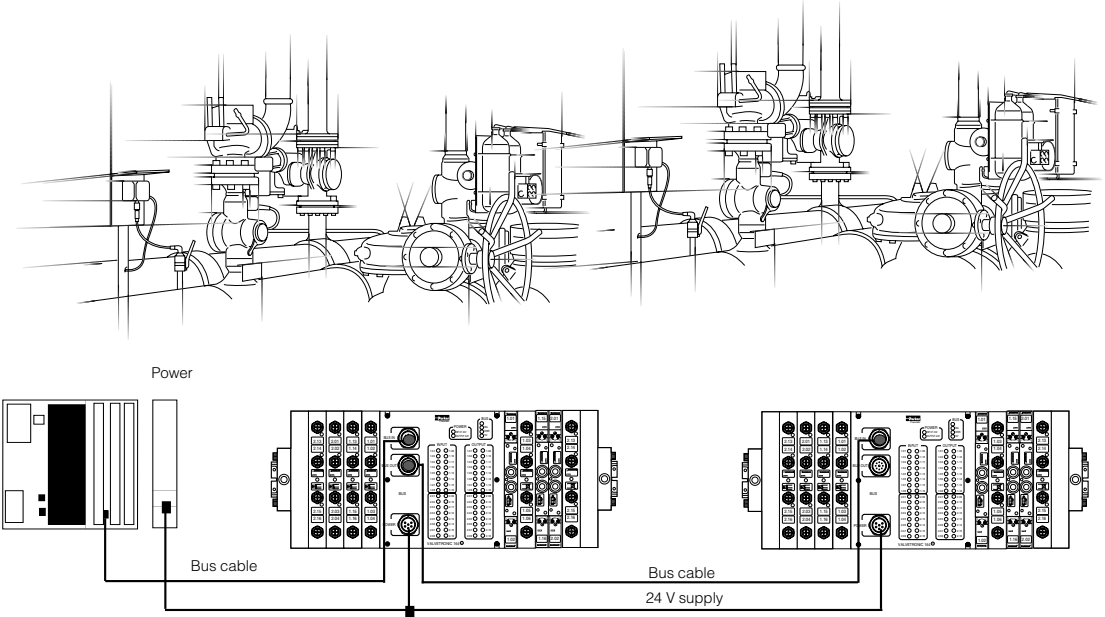

Typical application of Valvetronic system with sensor bus, cylinders distributed within less than 100 m.

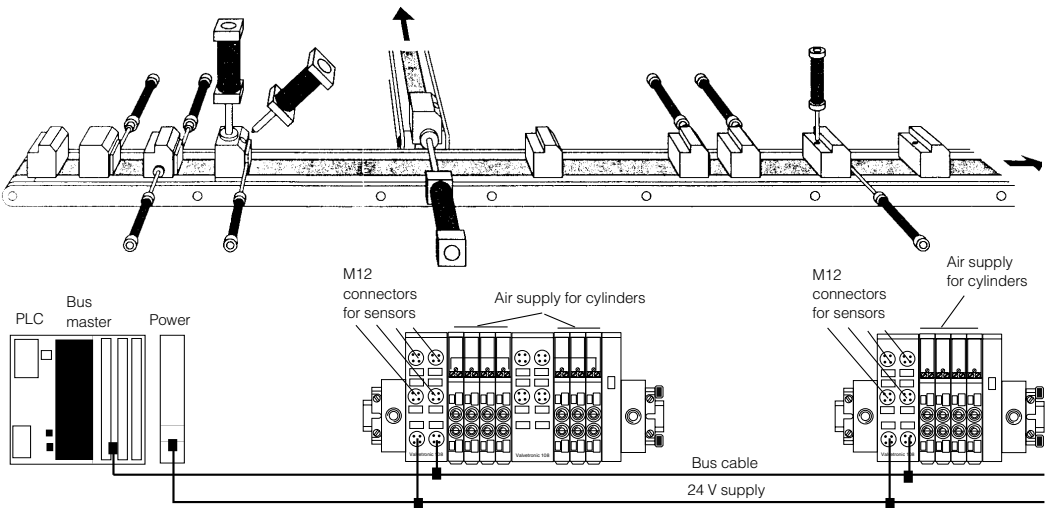

- High flow, compact, light weight
- Push-in or threaded pneumatic connections
- High performance 15 mm solenoid DIN 43 650 C
- 2 x 3/2 - 5/2 - 5/3 functions
- Electrical head connection by Sub D 25 or Industrial Cylindrical Connection
- Surface or DIN rail 35 mm mounting

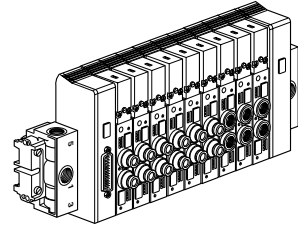

Operating information

PVL-B10 valves

Protection level	IP 65
Working Pressure	2 to 10 bar (3 to 10 bar for Monostable)
Storage temperature	-40 °C to +70 °C
Working temperature	-15 °C to +60 °C
Fluids	Air or neutral gas, 50 µm filtered, lubricated or not
Duty factor	100 %
Maximum operating frequency	10 Hz bistable
Solenoid voltage	12 to 48 V DC 24 to 115 V AC
Power consumption	1,2 W 1,6 VA Hold 1,2 W 3,5 VA Inrush
Orientation	Any plane
Visualisation	LED indicator
Surge suppression	Diode for DC version Varistor for AC version
Inverting commutation time	12 to 40 ms, according types

Input modules

Protection level	IP65
Voltage and type of output	PNP 24 V CC
Normal current	100 mA
Maxi. available current island for all the outputs	1 A

Output modules

Protection level	IP65
Type and output voltage	PNP 24 V CC
Normal current	100 mA
Maxi. available current island for all the inputs	1 A

Additional information

Modules for the DC version are protected against overvoltage up to 300 V. Protections on inductive loads connected to the same source are necessary.



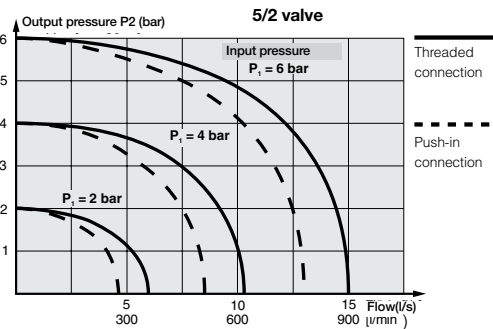

Modules for the AC version are fitted with a DC solenoid are compatible with PLC control card NPN protected.

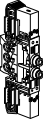

Flow characteristics

	Type 2 x 3/2 G1/8 threaded	Type 2 x 3/2 Push in Ø6 mm	Type 5/2 G1/8 threaded	Type 5/2 Push in Ø6 mm
Qn	7,33 l/s (440 l/min)	5,83 l/s (350 l/min)	9 l/s (540 l/min)	7,5 l/s (450 l/min)
Qmax	12,5 l/s (750 l/min)	10 l/s (600 l/min)	15 l/s (900 l/min)	12,9 l/s (775 l/min)
Cv	0,45	0,36	0,56	0,42
Kv	6,4	5,1	8	6
	Type 5/3 closed centre G1/8 threaded	Type 5/3 closed centre Push in Ø6 mm	Type 5/3 vented centre G1/8 threaded	Type 5/3 vented centre Push in Ø6 mm
Qn	6,16 l/s (370 l/min)	4,83 l/s (290 l/min)	9 l/s (540 l/min)	7,5 l/s (450 l/min)
Qmax	10,83 l/s (650 l/min)	8,33 l/s (500 l/min)	15 l/s (900 l/min)	12,9 l/s (775 l/min)
Cv	0,38	0,29	0,56	0,46
Kv	5,4	4,2	8	6,5

Main data for PVL-B

Symbol	Actuator	Return Pilot	Solenoid Connection	Pneumatic kg	Weight	Voltage	Order code
	Electric double 3/2 NC (2)	Internal air	With	Ø6 G1/8	0,240 0,240	24 VDC 24 VDC	PVL-B10560652B PVL-B10561852B
			Without	Ø6 G1/8	0,150 0,150	DC AC	PVL-B105606W2 PVL-B105606W1 PVL-B105618W2 PVL-B105618W1
		Spring	With	Ø6 G1/8	0,170 0,170	24 VDC 24 VDC	PVL-B10160652B PVL-B10161852B
			Without	Ø6 G1/8	0,125 0,125	DC AC	PVL-B101606W2 PVL-B101606W1 PVL-B101618W2 PVL-B101618W1
	Electric 5/2 (2)	Internal air	With	Ø6 G1/8	0,170 0,170	24 VDC 24 VDC	PVL-B10360652B PVL-B10361852B
			Without	Ø6 G1/8	0,125 0,125	DC DC	PVL-B103606W2 PVL-B103618W2
		Electric	With	Ø6 G1/8	0,240 0,240	24 VDC 24 VDC	PVL-B10260602B PVL-B10261802B
			Without	Ø6 G1/8	0,150 0,150	DC AC	PVL-B102606W2 PVL-B102606W1 PVL-B102618W2 PVL-B102618W1
	Electric 5/3 Closed Centre position* (1)	Electric Self centring	With	Ø6 G1/8	0,240 0,240	24 VDC 24 VDC	PVL-B10760602B PVL-B10761802B
			Without	Ø6 G1/8	0,150 0,150	DC AC	PVL-B107606W2 PVL-B107606W1 PVL-B107618W2 PVL-B107618W1
		Electric Self centring	With	Ø6 G1/8	0,240 0,240	24 VDC 24 VDC	PVL-B10860602B PVL-B10861802B
			Without	Ø6 G1/8	0,150 0,150	DC AC	PVL-B108606W2 PVL-B108606W1 PVL-B108618W2 PVL-B108618W1
	Electric 5/3 Pressurised Centre position* (1)	Electric Self centring	With	Ø6 G1/8	0,240 0,240	24 VDC 24 VDC	PVL-B10960602B PVL-B10961802B
			Without	Ø6 G1/8	0,150 0,150	DC AC	PVL-B109606W2 PVL-B109606W1 PVL-B109618W2 PVL-B109618W1
		Electric Self centring	With	Ø6 G1/8	0,240 0,240	24 VDC 24 VDC	PVL-B10960602B PVL-B10961802B
			Without	Ø6 G1/8	0,150 0,150	DC AC	PVL-B109606W2 PVL-B109606W1 PVL-B109618W2 PVL-B109618W1

(1) With override non locking flush
(2) With override locking flush



Configuration : Up to 16 valves or 32 I / O maximum

G

Monostable

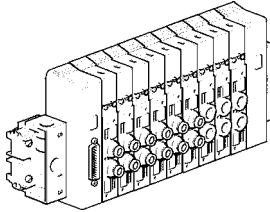

With SubD25 or
cylindrical 19 pins connector
⇒ 16 valves or 16 I/O

Monostable + Bistable

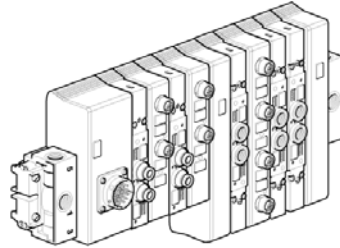

With SubD25 or
cylindrical 19 pins connector
⇒ 16 valves or 16 I/O

Bistable

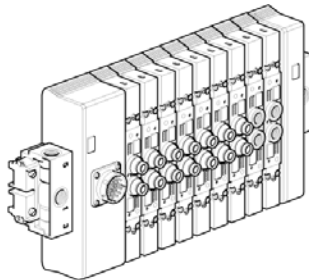

With SubD25 connector
⇒ 10 valves or 20 I/O
With cylindrical 35 pins connector
⇒ 16 valves or 32 I/O

Bistable + Monostable

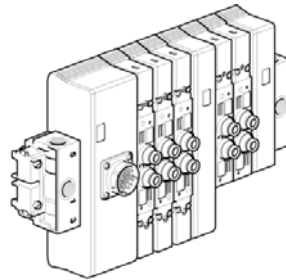

With SubD25 connector
⇒ 16 valves or 21 I/O
With cylindrical 35 pins connector
⇒ 16 valves or 32 I/O

Pneumatic head and tail sets

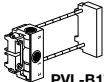
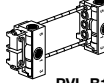
	Type of mounting	Description	Valve size	Pneumatic connection	Weight kg	Order code
	DIN rail mounting	Single air supply head and tail set	1/8"	G1/4	0,175	PVL-B1719
		Dual air supply head and tail set	1/8"	G1/4	0,245	PVL-B1729
	Surface mounting	Single air supply head and tail set	1/8"	G1/8	0,200	PVL-B1818
		Dual air supply head and tail set	1/8"	G1/8	0,260	PVL-B1828
		Pressure isolating disc		G1/8		PVL-B1902 Sold by lot of 10

Electrical head and tail sets

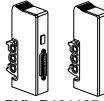
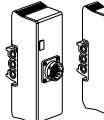
	Description	Valves configuration	Type of connector	Weight kg	Order code
	Head and tail sets	Monostable	Sub-D25	0,220	PVL-B191125
			Cylindrical 19-pins	0,250	PVL-B191219
		Bistable	Sub-D25	0,220	PVL-B192125
			Cylindrical 35-pins	0,250	PVL-B192235
	Head and tail sets	Bistable then monostable	Sub-D25	0,370	PVL-B194125
			Cylindrical 35-pins	0,420	PVL-B194235
		Monostable then bistable	Sub-D25	0,320	PVL-B193125
			Cylindrical 19-pins	0,350	PVL-B193219
		Transferring module	Bistable then monostable		0,220
	Monostable then bistable		0,240	PVL-B1930	

Electrical modules for external connection

	Description	Type	Connection	Weight kg	Order code
	Input module	PVL-B monostable	2 Inputs	0,180	PVL-B1E1302
		PVL-B bistable	4 Inputs	0,240	PVL-B1E2304
	Output module	PVL-B monostable	2 Outputs	0,180	PVL-B1S1302
		PVL-B bistable	4 Outputs	0,240	PVL-B1S2304

External input module connection

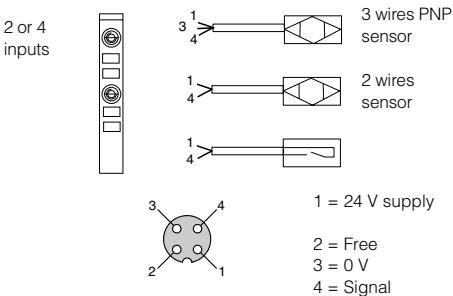

External output module connection

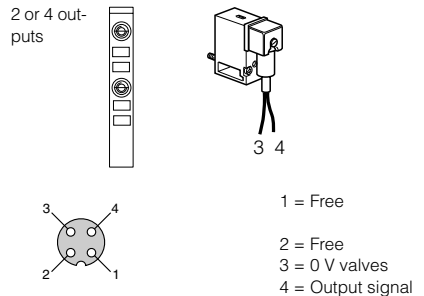

- Interbus S - Profibus DP - DeviceNet - FIPIO
- 2 x 3/2 - 5/2 - 5/3 valves 24 V DC with LEDs
- Protection level IP 65
- Up to 32 inputs and 32 outputs
- Visual indication Bus diagnostic by LEDs
- Output Module for driving external valves

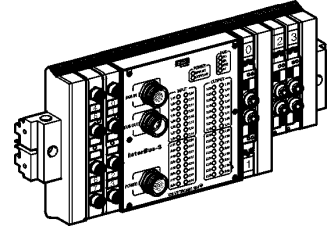

Operating information

Bus Head Modules

Protection level	IP 65
Diagnostic Bus	3 to 4 LED
Diagnostic voltage	2 LED
Short circuit protection	Diagnostic by LED on Outputs
Vibrations	IEC 68-2-6 1g
Shock	IEC 68-2-27 15 g 11 ms
EMC Protection	IEC 801-2 level 3 IEC 801-3 level 3 IEC 801-4 level 3
Working temperature	0 °C to 55 °C, 75% duty factor 0 °C to 40 °C, 100% duty factor
Storage temperature	-40 °C to +70 °C
Bus voltage	20,6 to 30 V DC
Solenoid voltage	21,6 to 26,4 V DC
Mounting	DIN rail 35 mm surface

Input modules

Protection level	IP 65
Type and input voltage	PNP 24 V DC
Maxi. available current island	1,5 A for all inputs
Normal current input at state 1	15 mA
Maximum current input state 0	3 mA
Minimum voltage input state 1	11 VDC

Output modules



Protection level	IP 65
Type and output voltage	PNP 24 V DC
Normal current	100 mA
Maxi. available current island	1,5 A for all outputs

Main data for Bus Head Module

Description	Type	Connection	Weight kg	Order code
 Bus Module*	Interbus	32 Inputs 32 Outputs	1,770	PVL-B1BS3232A
	Profibus DP	32 Inputs 32 Outputs	1,770	PVL-B1BP3232A
	DeviceNet	32 Inputs 32 Outputs	1,750	PVL-B1BD3232A
	FIPIO	32 Inputs 32 Outputs	1,700	PVL-B1BF3232A
Head and tails pneumatical module	Bistable then Monostable	G1/4	0,740	PVL-B194729
- air feed/anchoring blocks - transfer module	Bistable	G1/4	0,740	PVL-B192729
Connector	M23 female 6 pins power	Supply	0,030	P8C-MC06B
	M23 female 12 pins	Profibus	0,030	P8C-MC12BP
Plug	M23, IP 65	Bus Out	0,015	P8C-PB1
Installation Diskett	Profibus and DeviceNet		0,030	P8B-PDISK
Input Module	PVL-B Monostable	2 Input	0,180	PVL-B1E1302
	PVL-B Bistable	4 Input	0,240	PVL-B1E2304
Output Module	PVL-B Monostable	2 Output	0,180	PVL-B1S1302
	PVL-B Bistable	4 Output	0,240	PVL-B1S2304

* Spare front panel are available for replacements, Order code PVL-B••DEP

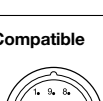
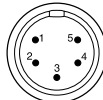
Connection on the Bus

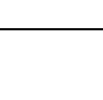
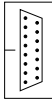
<p>Interbus S compatible</p> <p>Bus In  M23 male 9 pins*</p> <p>Bus Out  M23 female 9 pins*</p>	<p>DeviceNet compatible</p> <p>Bus  M18 male 5 pins*</p>
<p>Profibus DP Compatible</p> <p>Bus In  M23 female 12 pins</p> <p>Bus Out  M23 female 12 pins</p>	<p>FIPIO compatible</p> <p>Bus  Sub D 15 pins compatible with Schneider connector TSX-BLP10</p>



**32 Inputs or
 16 modules of 2 inputs maximum**
 8 Modules of 4 inputs
 Connector M12 female 5 pins
 1 input per connector
 with LED indicator

16 valves PVL-B10 or 32 outputs maximum
 Monostable or bistable
 32 pilot Solenoids or external outputs

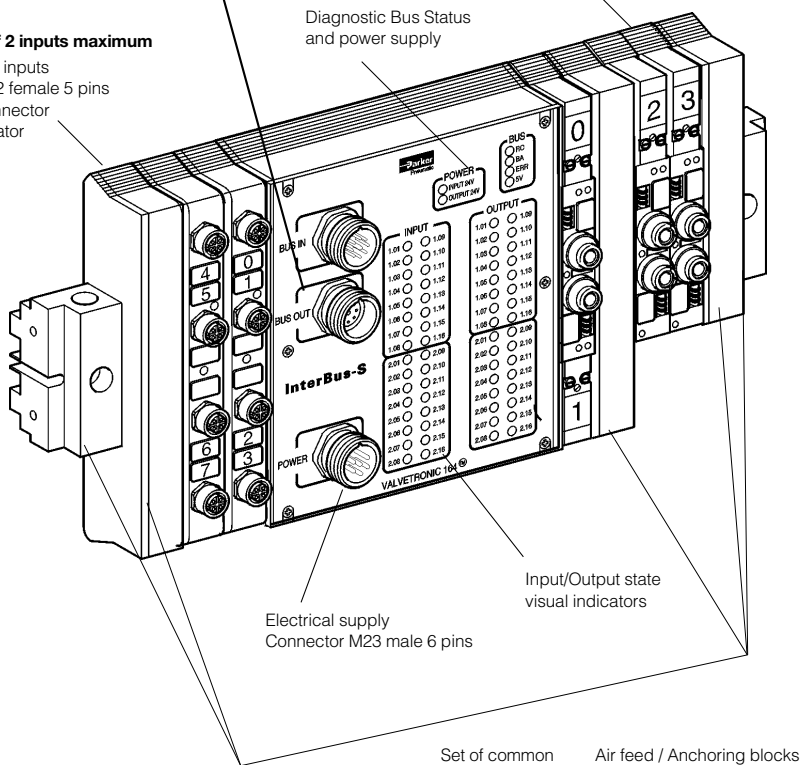

* We recommend to use connecting leads which conform to Interbus S such as Phoenix contact or equivalent.

- Total compatibility with ASI Bus
- Islands from 4 to 16 valves output
- Modularity of 4 outputs
- Protection level IP 65
- One single connection ASI
- One single connection Valve supply 24 V DC

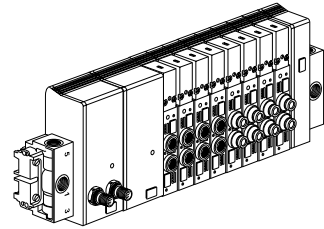

Operating information

ASI Bus Module characteristics

Protection level	IP 65
ASI operating voltage	26,9 to 31,6 V
Solenoid voltage	24 V DC ±10%
Operating voltage	0 to 55 °C
Vibrations	IEC 68-2-6 1g
Shock	IEC 68-2-27 15 g 11 ms
EMC Protection	IEC 801-2 level 3 IEC 801-3 level 3 IEC 801-4 level 3
Working temperature	0 °C to 55 °C
Identification code	8.F
Mounting	DIN rail

ASI Network characteristics

Maximum length	100 m
Maximum length with duplicator	200 m
Node capacity	4 inputs and 4 outputs
Total capacity	124 Inputs and 124 output
Number of nodes	1 to 31
Response time	5 ms maxi
Nodes supply	Through the Bus
Total available current	2 A or 5 A

Main data for ASI Bus Modules - Outputs version

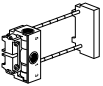
Description	Valves configuration	Connection	Weight kg	Order code
Head module*	Monostable valves	M12 ASI and valves supply	0,460	P2S-BA1BA40
Head* and transfer module	Monostable then bistable valves	M12 ASI and valves supply	0,560	P2S-BA3BA40
Head module*	Bistables valves	M12 ASI and valves supply	0,510	P2S-BA2BA40
Head* and transfer module	Bistable then monostable valves	M12 ASI and valves supply	0,610	P2S-BA3BA40
Transfer module	Monostable valves	-	0,410	P2S-BA5BA40
	Bistable valves	-	0,460	P2S-BA6BA40
Air supply module	DIN rail mounting	Single air supply G1/4	0,175	PVL-B1719
		Dual air supply G1/4	0,245	PVL-B1729
		Surface mounting		
 PVL-B1719		Single air supply G1/8	0,200	PVL-B1818
		Dual air supply G1/8	0,260	PVL-B1828
Connecting lead to the ASI module addressing terminal (type P2S-BA...)			0,15	P8L-MH02B1

* Head module = with ASI, and supply 24V DC connection

- Total compatibility with ASI Bus
- Islands from 4 to 16 valves output and 4 or 16 inputs
- Protection level IP 65
- Connection M12 or Vampire plug
- ASI visualisation and 24 V supply diagnostic by LED
- Inputs visualisation by LED

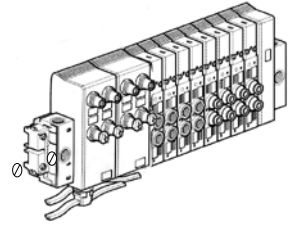

Operating information

ASI Bus Module Characteristics

Protection level	IP 65
ASI operating voltage	26,9 to 31,6 V
Solenoid voltage	24 VDC ±10%
Isolation voltage	1500 V
Vibrations	IEC 68-2-6 1g
Shock	IEC 68-2-27 15 g 11 ms
EMC Protection	IEC 801-2 level 3 IEC 801-3 level 3 IEC 801-4 level 3
Bus diagnostic	2 LED, red and green
Solenoid voltage visualisation	By LED
Short circuit protection	Diagnostic by LED
Working temperature	0 °C to 55 °C
Storage temperature	-40 °C to 70 °C
Solenoid voltage	ASI Vampire plug or M12

Identification code	7.F
Bus connection	ASI Vampire plug or M12 Connector
Available current on inputs	200 mA
Compatibility with sensors or photo-cells	2 or 3 wires technology
Inputs	PNP type

ASI Network characteristics

Maximum length	100 m
Maximum length with duplicator	200 m
Node capacity	4 inputs and 4 outputs
Total capacity	124 Inputs and 124 output
Number of nodes	1 to 31
Response time	5 ms maxi
Nodes supply	Through the Bus
Total available current	2 A or 5 A

Main data for ASI Bus Modules - Inputs and Outputs version

Description	Valves	Connection configuration	Weight kg	Order code
Head module*	Monostable valves	M12 ASI and valves supply	0,460	PVL-BA1BA44
		Vampire ASI and valves supply	0,460	PVL-BA1BA44V
Head module*	Monostable then bistable valves	M12 ASI and valves supply	0,560	PVL-BA3BA44
		Vampire ASI and valves supply	0,560	PVL-BA3BA44V
Transfer module	Monostable or bistable valves		0,400	PVL-BA5BA44
Air supply module	DIN rail mounting	Single air supply G1/4	0,175	PVL-B1719
		Dual air supply G1/4	0,245	PVL-B1729
Air supply module	Surface mounting	Single air supply G1/8	0,200	PVL-B1818
		Dual air supply G1/8	0,260	PVL-B1828
Spare Vampire cover dip Sold by lot of 5				P8B-AVMP2
Connecting lead to the ASI module addressing terminal (type PVL-BA...)				P8B-AJACK

* Head module = with ASI, and supply 24V DC connection

Connection

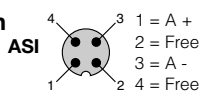

Valves supply

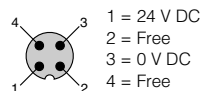

Inputs

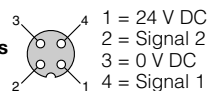

- High flow, compact, light weight
- Push-in or threaded pneumatic outlets
- High performance 15 mm solenoid DIN 43 650 C
- DIN rail or surface mounting
- Electrical head connection by Cable gland, Sub D 25 or Industrial Cylindrical Connection

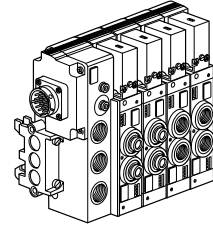

Operating information

Protection level	IP 65	Solenoid voltage	12 to 48 V DC 24 to 115 V AC (other voltages available as option)
Working Pressure	2 to 10 bar (3 to 10 bar for Monostable)	Surge consumption	1,2 W 1,6 VA Hold 1,2 W 3,5 VA Inrush
Working temperature	-15 °C to 60 °C	Orientation	Any plane
Storage temperature	-40 °C to 70 °C	Surge suppression	Diode for DC version Varistor for AC version
Fluids	Air or gas, 50 µm filtered, lubricated or not	Inverting commutation time	15 to 112 ms, according types
Mechanical life with dry air at 6 bar, 20 °C, 1 Hz:	30 million cycles		
Duty factor	100 %		
Maximum operating frequency	10 Hz bistable		

Additional information

Modules for the DC version are protected against overvoltage up to 300 V. Protections on inductive loads connected to the same source are necessary.

Modules for the AC version fitted with a DC solenoid are compatible with PLC control card NPN protected.

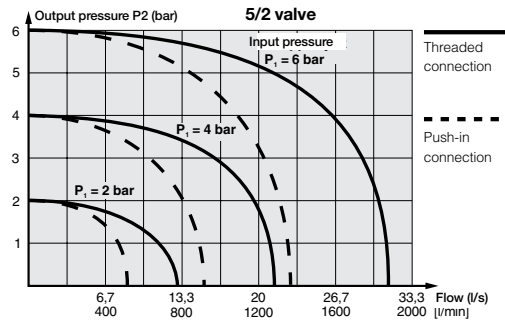

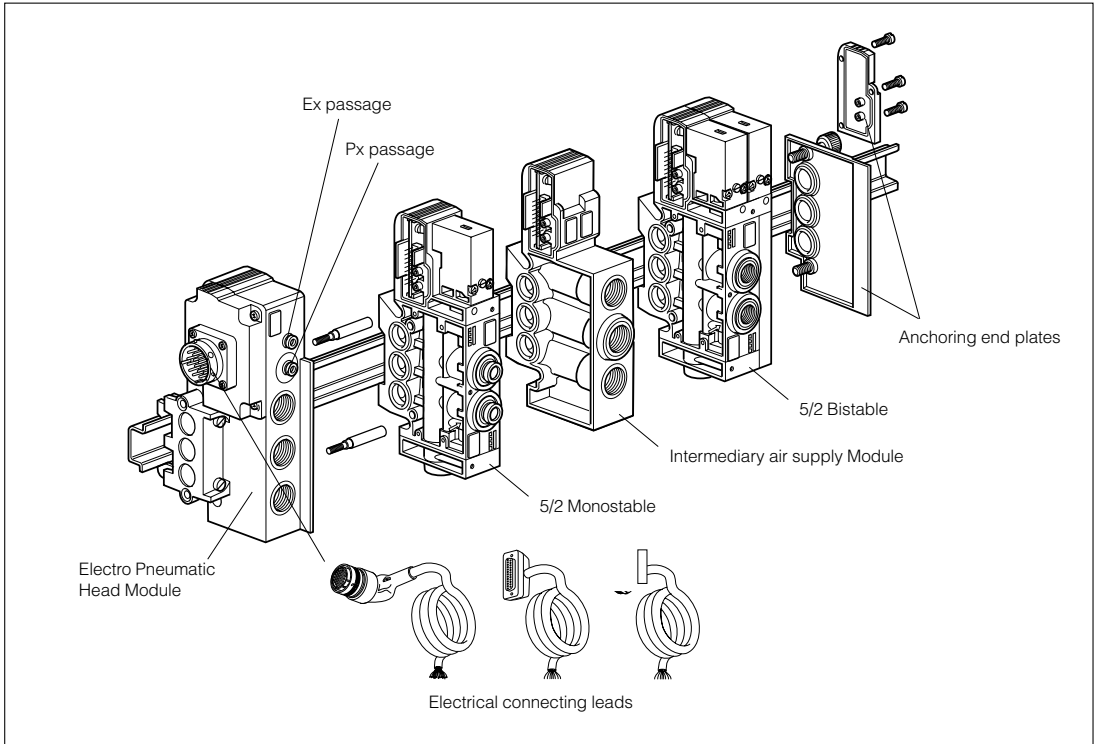

Flow characteristics

	Type 2 x 3/2 G1/8 threaded	Type 2 x 3/2 Push in Ø8 mm	Type 5/2 G1/4 threaded	Type 5/2 Push in Ø8 mm
Qn	9,5 l/s (570 l/min)	9 l/s (540 l/min)	18,33 l/s (1100 l/min)	14 l/s (840 l/min)
Qmax	15,8 l/s (950 l/min)	15 l/s (900 l/min)	30,83 l/s (1850 l/min)	23,3 l/s (1400 l/min)
Cv	0,58	0,55	1,11	0,86
Kv	8,3	7,8	16	12,2
	Type 5/3 closed centre G1/4 threaded	Type 5/3 closed centre Push in Ø8 mm	Type 5/3 vented centre G1/4 threaded	Type 5/3 vented centre Push in Ø8 mm
Qn	13 l/s (780 l/min)	11,6 l/s (700 l/min)	18,33 l/s (1100 l/min)	14 l/s (840 l/min)
Qmax	21,66 l/s (1300 l/min)	19,5 l/s (1170 l/min)	30,83 l/s (1850 l/min)	23,3 l/s (1400 l/min)
Cv	0,79	0,71	1,11	0,86
Kv	11,3	10,2	16	12,2
	Type 5/3 pressurised centre G1/4 threaded	Type 5/3 pressurised centre Push in Ø8 mm		
Qn	11 l/s (660 l/min)	10,5 l/s (630 l/min)		
Qmax	18,33 l/s (1100 l/min)	17,5 l/s (1050 l/min)		
Cv	0,67	0,64		
Kv	9,6	9,2		

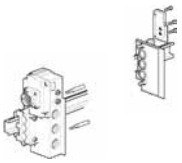

G

Main data for Head and tail Electro-pneumatic modules

	Description	Auxiliary Pressure Px	Electrical Connection	Pneumatic Connection	Order code
	Head modules	Without Px*	HE10 with cable gland	G3/8	PVL-C1713H20A
			Sub D 25	G3/8	PVL-C1713D25A
			Cylindrical connection 19 pins	G3/8	PVL-C1713C19A
		With Px *	HE10 with cable gland	G3/8	PVL-C2713H20A
			Sub D 25	G3/8	PVL-C2713D25A
			Cylindrical connection 19 pins	G3/8	PVL-C2713C19A
	Tail air feed Module	-	-	G3/8	PVU-LC213 **
	Intermediary air supply module	-	-	G3/8	PVU-LC213E ***
	Pressure isolating discs	-	-	G1/4	PVL-C1902 Sold by lot of 10





Ex = to collect the exhausts of the solenoids

* Px = auxiliary air supply for solenoids, separately from the main valves air supply

** To be mounted at the end of the island valves for dual air supply (without electrical connections)

*** For dual air supply ou different supplies, with no defined location in the island valves (with connections fitted)

Main data for PVL-C

Symbol	Actuator	Return Pilot	Solenoid connection	Pneumtical kg	Weight	Voltage	Order code
	Electric double 3/2 NC (2)	Internal air	With	Ø8 G1/4	0,240 0,240	24 VDC 24 VDC	PVL-C10560852B PVL-C10561952B
			Without	Ø8 G1/4 G1/4 G1/4	0,150 0,150 0,150 0,150	DC AC DC AC	PVL-C105608W2 PVL-C105608W1 PVL-C105619W2 PVL-C105619W1
		Spring	With	Ø8 G1/4	0,170 0,170	24 VDC 24 VDC	PVL-C10160852B PVL-C10161952B
			Without	Ø8 Ø8 G1/4 G1/4	0,125 0,125 0,125 0,125	DC AC DC AC	PVL-C101608W2 PVL-C101608W1 PVL-C101619W2 PVL-C101619W1
	Electric 5/2 (2)	Internal air	With	Ø8 G1/4	0,170 0,170	24 VDC 24 VDC	PVL-C10360852B PVL-C10361952B
			Without	Ø8 G1/4	0,125 0,125	DC DC	PVL-C103608W2 PVL-C103619W2
	Electric 5/2 (2)	Internal air	With	Ø8 G1/4	0,170 0,170	24 VDC 24 VDC	PVL-C10360852B PVL-C10361952B
			Without	Ø8 G1/4	0,125 0,125	DC DC	PVL-C103608W2 PVL-C103619W2
		Electric	With	Ø8 G1/4	0,240 0,240	24 VDC 24 VDC	PVL-C10260802B PVL-C10261902B
			Without	Ø8 Ø8 G1/4 G1/4	0,150 0,150 0,150 0,150	DC AC DC AC	PVL-C102608W2 PVL-C102608W1 PVL-C102619W2 PVL-C102619W1
	Electric 5/3 Closed Centre position (1)	Self centring	With	Ø8 G1/4	0,240 0,240	24 VDC 24 VDC	PVL-C10760802B PVL-C10761902B
			Without	Ø8 Ø8 G1/4 G1/4	0,150 0,150 0,150 0,150	DC AC DC AC	PVL-C107608W2 PVL-C107608W1 PVL-C107619W2 PVL-C107619W1
			With	Ø8 G1/4	0,240 0,240	24 VDC 24 VDC	PVL-C10860802B PVL-C10861902B
		Self centring	Without	Ø8 Ø8 G1/4 G1/4	0,150 0,150 0,150 0,150	DC AC DC AC	PVL-C108608W2 PVL-C108608W1 PVL-C108619W2 PVL-C108619W1
			With	Ø8 G1/4	0,240 0,240	24 VDC 24 VDC	PVL-C10960802B PVL-C10961902B
			Without	Ø8 Ø8 G1/4 G1/4	0,150 0,150 0,150 0,150	DC AC DC AC	PVL-C109608W2 PVL-C109608W1 PVL-C109619W2 PVL-C109619W1

(1) With override non locking flush (version with solenoid fitted)

(2) With override locking flush (version with solenoid fitted)

- One common Electrical Head Connection for both sizes
- Two separated air feeds 1/4 and 1/8 for dual air supply
- Simple connection of 1/8 and 1/4 sizes (wire free connecting system)
- Up to 21 Pilot Solenoids (Sub D 25 version)
- Up to 32 Pilot Solenoids (Cylindrical 35 version)

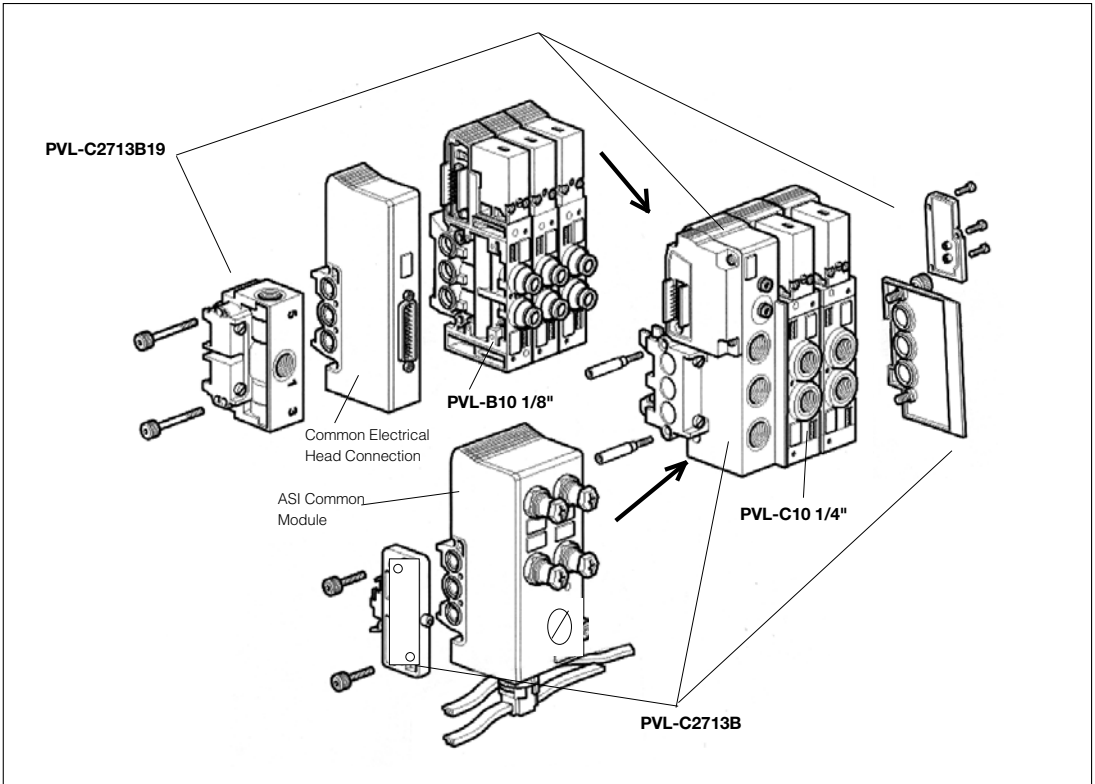

Main data for Combination Kits PVL-B10/PVL-C10

Type of combination module		Connection	Weight kg	Order code
Combination PVL-B10/PVL-C10	Without Px version*	G 1/4 and G 3/8	0,450	PVL-C1713B19
	With Px version(Ø4 mm) *	G 1/4 and G 3/8	0,460	PVL-C2713B19
Combination bus ASI/PVL-C10	Without Px version*	G 3/8	0,380	PVL-C1713B
	With Px version(Ø4 mm) *	G 3/8	0,390	PVL-C2713B

* Px = auxiliary air supply for solenoids, separately from the main valves air supply.

- Total compatibility with ASI Bus
- Islands from 4 to 16 valves output
- Modularity of 4 Outputs
- Protection level IP 65
- One single connection ASI
- One single connection Valve supply 24 V DC

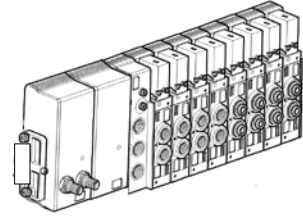

Operating information

ASI Bus Module characteristics

Protection level	IP 65
ASI operating voltage	26,9 to 31,6 V
Solenoid voltage	24 V DC $\pm 10\%$
Operating voltage	0 to 55 °C
Vibrations	IEC 68-2-6 1g
Shock	IEC 68-2-27 15 g 11 ms
EMC Protection	IEC 801-2 level 3 IEC 801-3 level 3 IEC 801-4 level 3
Working temperature	0 °C to 55 °C
Identification code	8.F
Mounting	DIN rail

ASI Network characteristics

Maximum length	100 m
Maximum length with duplicator	200 m
Node capacity	4 inputs and 4 outputs
Total capacity	124 Inputs and 124 output
Number of nodes	1 to 31
Response time	5 ms maxi
Nodes supply	From the Bus
Total available current	2 A or 5 A

Main data for ASI Bus Modules - Outputs version

Description	Connection	Weight kg	Order code	
Head module	M12 ASI and valves supply	0,460	P2S-BA1BA40	
Intermediary air feed module	-	0,410	P2S-BA5BA40	
Associating module on ASI Bus with	Without Px version*	G 3/8	0,305	PVL-C1713B
air supply	With Px version ($\varnothing 4$ mm)*	G 3/8	0,310	PVL-C2713B
Connecting lead to the ASI module addressing terminal	-	0,150	P8L-MH02B1	

* Px = auxiliary air supply for solenoids, separately from the main valves air supply.

- Total compatibility with ASI Bus
- Islands from 4 to 16 valves output and 4 to 16 inputs
- Protection level IP 65
- Connection M12 or Vampire plug
- ASI indication and 24 V supply diagnostic by LED
- Inputs indication by LED

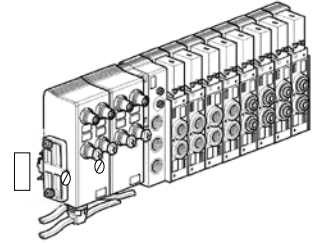

Operating information

ASI Bus Module characteristics

Protection level	IP 65
ASI operating voltage	26,9 to 31,6 V
Solenoid voltage	24 V DC ±10%
Isolation voltage	1500 V
Vibrations	IEC 68-2-6 1g
Shock	IEC 68-2-27 15 g 11 ms
EMC Protection	IEC 801-2 level 3 IEC 801-3 level 3 IEC 801-4 level 3
Bus diagnostic	2 LED, red and green
Solenoid voltage indication	By LED
Short circuit protection	Diagnostic by LED
Working temperature	0 °C to 55 °C
Storage temperature	-40 °C to 70 °C
Solenoid voltage	ASI Vampire plug or M12

Identification code	7.F
Bus connection	ASI Vampire plug or M12 Connector
Available current on inputs	200 mA
Compatibility with sensors or photo-cells	2 or 3 wires technology
Inputs	PNP type

ASI Network characteristics

Maximum length	100 m
Maximum length with duplicator	200 m
Node capacity	4 inputs and 4 outputs
Total capacity	124 Inputs and 124 output
Number of nodes	1 to 31
Response time	5 ms maxi
Nodes supply	Through the Bus
Total available current	2 A or 5 A

Main data for ASI Bus Modules - Inputs and Outputs version

Description	Connection	Weight kg	Order code
Head module	M12 ASI and valves air supply	0,460	PVL-BA1BA44
	Vampire ASI and valves air supply	0,460	PVL-BA1BA44V
Intermediary air feed module	-	0,400	PVL-BA5BA44
Associating module on ASI Bus with air supply	Without Px version*	G 3/8	PVL-C1713B
	With Px version (Ø4 mm) *	G 3/8	PVL-C2713B
Connecting lead to the ASI module addressing terminal	-	0,150	P8B-AJACK
Spare Vampire cover clip	-	0,150	P8B-AVMP2

Sold by lot of 5

* Px = auxiliary air supply for solenoids, separately from the main valves air supply.

Connection

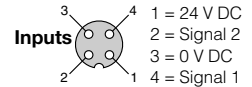
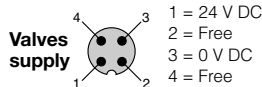
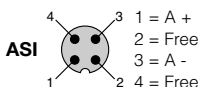

- Interbus S - Profibus DP - DeviceNet
- Up to 16 outputs
- Simple connections to PVL-B (1/8") and/or PVL-C (1/4")
- Protection level IP 65
- Bus diagnostic visualisation by LED

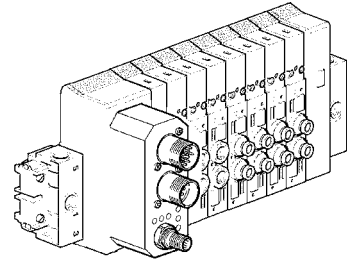

Operating information

Protection level	IP 65
Diagnostic Bus	3 to 4 LED
Diagnostic voltage	2 LED
Vibrations	IEC 68-2-6 1g
Shocks	IEC 68-2-7 15 g 11 ms
EMC Protection	EN55011, level B EN61000-4-2, level B EN61000-4-3, level A EN61000-4-4, level B EN61000-4-6, level A
Working temperature	0 °C to 55 °C
Storage temperature	-40 °C to +70 °C
Bus supply voltage	20,4 to 30 V DC
Solenoid supply voltage	21,6 to 26,4 V DC

Additional information

Electrical power supply connection on head module

Connector M12 male 5 pins
(common to all Field Bus)

Bus connection on head module Interbus S

Connector M23 male 9 pins (Bus IN)
Connector M23 female 9 pins (Bus Out)

Profibus DP

Connector M12 male 5 pins (Bus IN)
Connector M12 female 5 pins (Bus Out)



DeviceNet

Connector M12 male 5 pins (Bus)

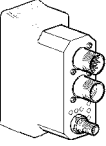
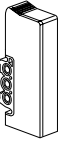
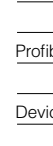
Main data for 16 outputs Device bus Modules (Interbus S - Profibus DP - DeviceNet)

Description	Connection	Weight kg	Order code
 Interbus S module	-	0,560	PVL-B1BS1600A
 Profibus DP module	-	0,490	PVL-B1BP1600A
 DeviceNet module	-	0,490	PVL-B1BD1600A

Mounting accessories for 16 outputs Device bus Modules

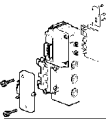
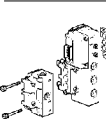
	PVL-B10 supply module	Single air supply G1/4	0,175	PVL-B1719
		Dual air supply G1/4	0,245	PVL-B1729
	Kit for bistable PVL-B mounting (or transfert mono-bistable)		0,240	PVL-B1930
	PVL-C air supply module	G 3/8 (without Px version)	0,380	PVL-C1713B
		G 3/8 (with Px version)	0,390	PVL-C2713B
	Kit for PVL-B and PVL-C mixing including PVL-B and PVL-C air supply	G 1/4 and G 3/8 (without Px on PVL-C)	0,450	PVL-C1713B19
		G 1/4 and G 3/8 (with Px on PVL-C)	0,460	PVL-C2713B19

Note : for bus connectors and installation diskett, use the same as for interface 2000

**16 outputs Device bus module
with PVL-B monostable valves**

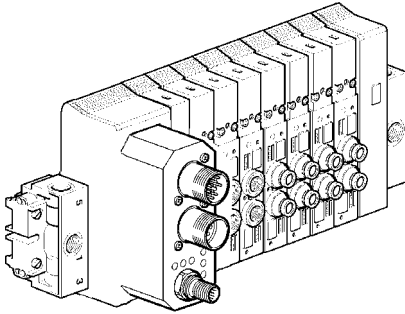

**16 outputs Device bus module
with PVL-B monostable and bistable valves**

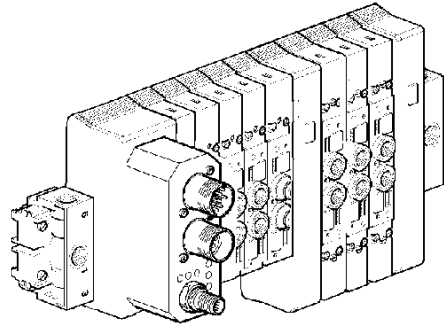

**16 outputs Device bus module
with PVL-C monostable or bistable valves**

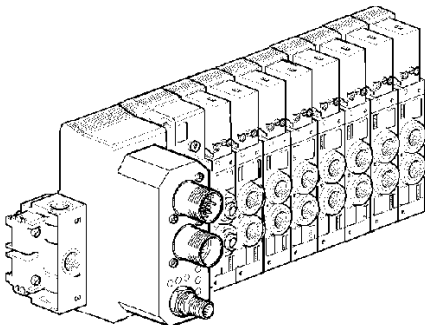

**16 outputs Device bus module
with PVL-B and PVL-C valves**

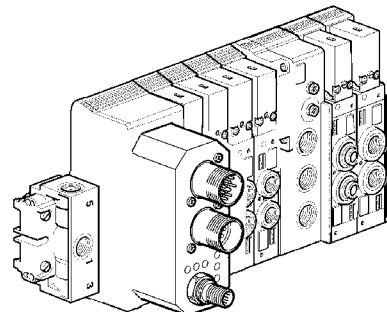

G

- High performance and flow
- 8 mm Pin spacing
- UL Listed (according types)
- IP 65 Encapsulated coil (connected)
- Full compliance with European Directives 73/23/EEC "Low Voltage"
89/336/EEC "Electro-Magnetic Compability"

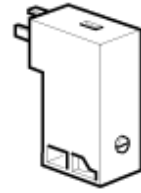

Operating information

	NC, Standard flow	NO, Standard flow	NC, High flow
Working pressure	0 to 10 bar	0 to 10 bar	0 to 10 bar
Working temperature	-15 °C to +60 °C	-15 °C to +50 °C	-15 °C to +50 °C
Orifice diameter	1,0 mm	1,1 mm	1,4 mm
Flow Qmax	33 NI/min	33 NI/min	50 NI/min
Power, Hold	DC1,2 W / AC1,6 VA	DC1,8 W / AC 2,4 VA	DC1,8 W / AC 2,4 VA
Power, Inrush	1,2 W / AC 3,5 VA	1,8 W / AC 5,5 VA	1,8 W / AC 5,5 VA
Voltage range	+ 10 %, -15 %	+ 10 %, -15 %	+ 10 %, -15 %

Note! Solenoids are supplied without screws.

Solenoid 15 mm NC Standard flow

(electrical interface same side as pneumatic interface)

	Voltage	Weight	Order code	Weight	Order code	Weight	Order code
		kg	Without manual override	kg	With manual override Non locking flush	kg	With manual override Locking flush
<p>120 VAC 60Hz</p>	12 VDC	0,038	P2E-KS32B0	0,038	P2E-KS32B1	0,038	P2E-KS32B2
	24 VDC	0,038	P2E-KS32C0	0,038	P2E-KS32C1	0,038	P2E-KS32C2
	48 VDC	0,038	P2E-KS32D0	0,038	P2E-KS32D1	0,038	P2E-KS32D2
	24 VAC 50Hz	0,038	P2E-KS31C0	0,038	P2E-KS31C1	0,038	P2E-KS31C2
	48 VAC 50/60Hz	0,038	P2E-KS34D0	0,038	P2E-KS34D1	0,038	P2E-KS34D2
	115 VAC 50Hz/	0,038	P2E-KS31F0	0,038	P2E-KS31F1	0,038	P2E-KS31F2
	Voltage		Weight	Order code	Weight	Order code	
			kg	With manual override Extended non locking	kg	With manual override Extended locking	
	24 VDC		0,038	P2E-KS32C3	0,038	P2E-KS32C4	
	24 VAC 50Hz		0,038	P2E-KS31C3	0,038	P2E-KS31C4	

Solenoid 15 mm NO Standard flow

(electrical interface same side as pneumatic interface)

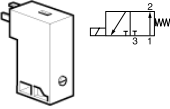

Voltage	Weight kg	Order code Without manual override	Weight kg	Order code Override Non locking flush	Weight kg	Order code Override Locking flush
24 VDC	0,038	P2E-KS12C0	0,038	P2E-KS12C1	0,038	P2E-KS12C2
24 VAC 50Hz	0,038	P2E-KS11C0	0,038	P2E-KS11C1	0,038	P2E-KS11C2

Voltage	Weight kg	Order code Override extended non locking	Weight kg	Order code Override extended locking
24 VDC	0,038	P2E-KS12C3	0,038	P2E-KS12C4
24 VAC 50Hz	0,038	P2E-KS11C3	0,038	P2E-KS11C4

Solenoid 15 mm NC High flow

(electrical interface same side as pneumatic interface)

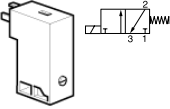

Voltage	Weight kg	Order code Without manual override	Weight kg	Order code Override flush Non locking	Weight kg	Order code Override flush Locking
24 VDC	0,038	P2E-HS32C0	0,038	P2E-HS32C1	0,038	P2E-HS32C2
24 VAC 50Hz	0,038	P2E-HS31C0	0,038	P2E-HS31C1	0,038	P2E-HS31C2
48 VDC	0,038	P2E-HS32D0	0,038	P2E-HS32D1	0,038	P2E-HS32D2
115 V 50Hz / 120 V 60Hz	0,038	P2E-HS31F0	0,038	P2E-HS31F1	0,038	P2E-HS31F2

Voltage	Weight kg	Order code Override extended non locking	Weight kg	Order code Override extended locking
24 VDC	0,038	P2E-HS32C3	0,038	P2E-HS32C4
24 VAC 50Hz	0,038	P2E-HS31C3	0,038	P2E-HS31C4
48 VDC	0,038	P2E-HS32D3	0,038	P2E-HS32D4
115 V 50Hz / 120 V 60Hz	0,038	P2E-HS31F3	0,038	P2E-HS31F4

Main data for spare set of Solenoids Mounting screws

Kit	Type	Material	Ø mm	Length mm	Weight kg	Order code
	Metric	Steel, passivated	M3	26	0,02	P2E-KP026PM3 *
	Self tapping	Steel, passivated	Ø 3 mm	25	0,02	P2E-KP025PS3 *

*Sold by lot of 10

Correspondence table between screws and Valves Series

Valvetronic Series	Description	Mounting screw length	Order code Mounting screw kit
P2S-HW	Valvetronic Solstar	25 mm	P2E-KP025PS3
P2S-EW	Interface 2000	26 mm	P2E-KP026PM3
PVL-B10	Valvetronic 1/8"	26mm	P2E-KP026PM3
PVL-C10	Valvetronic 1/4"	26 mm	P2E-KP026PM3

- Leads and connector (plugged in)
- Protection level IP 65
- Suitable for use across the Valvetronic Modular program
- HE 10 for budget cable gland version
- Sub D 25 for compact version
- Cylindrical 19 or 35 pins for heavy duty industrial

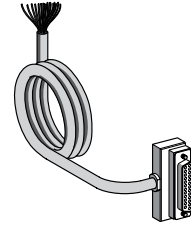

General characteristics

Working temperature	-15 C° to 60 °C
Working current;	
AWG20	5 A
AWG24	2,5 A
AWG28	1 A

Main data for Connecting leads for Head module with cover gland (HE10)

Type	Connection to valve island	Connection to the control system	Lenght m	Weight kg	Order code
	HE10/HE14 female	20 coloured wires AWG 24	5,0	0,510	P8L-MH20A5
			9,9	1,010	P8L-MH20A9
		HE10 20 pins for direct	1,5	0,160	P8L-MH20A1BH20A
		plug-in connection on PLC AWG24	3,0	0,310	P8L-MH20A3BH20A
			5,0	0,510	P8L-MH20A5BH20A
			9,9	1,010	P8L-MH20A9BH20A

Main data for Connecting leads for Head module with Sub D 25

Type	Connection to valve island	Connection to the control system	Lenght m	Weight kg	Order code
	Leads for head module with Sub D 25 female	20 coloured wires AWG 24	5,0	0,540	P8L-MD25A5B
			9,9	1,040	P8L-MD25A9B
			15,0	1,540	P8L-MD25ACB
		25 wires roles flat ribbon AWG 28	5,0	0,540	P8L-MD25A5
			9,9	0,540	P8L-MD25A9
		HE10 20 pins for direct	1,5	0,160	P8L-MD25A1BH20A
		plug-in connection on PLC	3,0	0,310	P8L-MD25A3BH20A
			5,0	0,510	P8L-MD25A5BH20A
		9,9	1,010	P8L-MD25A9BH20A	

Main data for Connecting leads for Head module with Cylindrical Heavy duty connector

Type	Connection to valve island	Connection to the control system	Lenght m	Weight kg	Order code
	Cylindric connector	19 pins max. Ø cable = 16 mm	To be wired	0,060	P8C-MC19A
		35 pins max. Ø cable = 22 mm	To be wired	0,090	P8C-MC35A
	Leads with cylindric	19 coloured wires AWG 20 (16 outputs)	5,0		P8L-MC19A5
		max. Ø cable = 12 mm	9,9		P8L-MC19A9
	Connection	35 coloured wires AWG 20 (32 outputs)	5,0		P8L-MC35A5
		max. Ø cable = 15 mm	9,9		P8L-MC35A9

Wiring connection for cable gland and Sub D 25 with AWG 24 wire

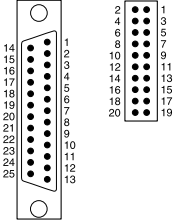

Colour	Input or Output N°	Sub D 25 Pin Nr	HE10 Pin Nr
Green	0	13	1
Tranparent	1	25	2
Dark blue	2	12	3
Light blue	3	24	4
Pink	4	11	5
Purple	5	23	6
Dark green/Black	6	10	7
Yellow	7	22	8
Light green/Black	8	9	9
Yellow/black	9	21	10
Blue/Black	10	8	11
White/Black	11	20	12
Khaki	12	7	13

Colour	Input or Output Nr	Sub D 25 Pin Nr	HE10 Pin Nr
Orange	13	19	14
White	14	6	15
Grey	15	18	16
Red/Black	Free	5	17
Red	24 V	17	17
Brown	0 V	4	18
Black	0 V	16	18
	16	3	-
	17	15	-
	18	2	-
	19	14	-
*	20	1	-

* Red wire for flat ribbon cable

Wiring connection for Sub D 25 with rolled flat ribbon AWG 28 wires

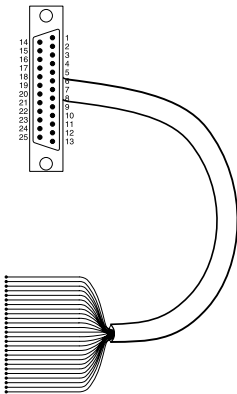

Colour	Nr of Ribbon wires after red wire	Sub D Pin Nr	Input/Output Nr
Grey	24	13	0
Grey	23	25	1
Grey	22	12	2
Grey	21	24	3
Grey	20	11	4
Grey	19	23	5
Grey	18	10	6
Grey	17	22	7
Grey	16	9	8
Grey	15	21	9
Grey	14	8	10
Grey	13	20	11
Grey	12	7	12

Colour	Nr of Ribbon wires after red wire	Sub D Pin Nr	Input/Output Nr
Grey	11	19	13
Grey	10	6	14
Grey	9	18	15
Grey	8	5	Free
Grey	7	17	24 V
Grey	6	4	0 V Inputs
Grey	5	16	0V Valves
Grey	4	3	16
Grey	3	15	17
Grey	2	2	18
Grey	1	14	19
Red	0 (Red wire)	1	20

Wiring connection for cylindrical 19 or 35 pins with AWG 20 wires

I/O Nr	Colour	Connector 19 Pin Nr	Connector 35 Pin Nr	I/O Nr	Colour	Connector 19 Pin Nr	Connector 35 Pin Nr	I/O Nr	Colour	Connector 19 Pin Nr	Connector 35 Pin Nr		
0	Pink-Brown	A	A	9	Violet	K	K	18	White-Black	-	V		
1	White-Green	B	B	10	Blue	L	L	19	Brown-Blue	-	W		
2	White-Yellow	C	C	11	Pink	M	M	20	Brown-Red	-	X		
3	White-Grey	D	D	12	Grey	N	N	21	Brown-Black	-	Y		
4	White-Pink	E	E	13	Yellow	P	P	22	Grey-Green	-	Z		
5	Brown-Green	F	F	14	White	R	R	23	Pink-Green	-	a		
6	Red-Blue	G	G	15	Green	S	S	24	Green-Blue	-	b		
7	Grey-Pink	H	H	16	White-Blue	-	T	25	Green-Red	-	c		
8	Yellow-Brown	J	J	17	White-Red	-	U	26	Green-Black	-	d		
									27	Yellow-Grey	-	e	
									28	Yellow-Pink	-	f	
									29	Yellow-Blue	-	g	
									30	Yellow-Red	-	h	
									31	Yellow-Black	-	i	
										0 V valves	Black	T	j
										0 V inputs	Brown	U	k
										24 V inputs	Red	V	m

Dimensions, Valvetronic Solstar

Configuration Solstar with intermediary air feed module

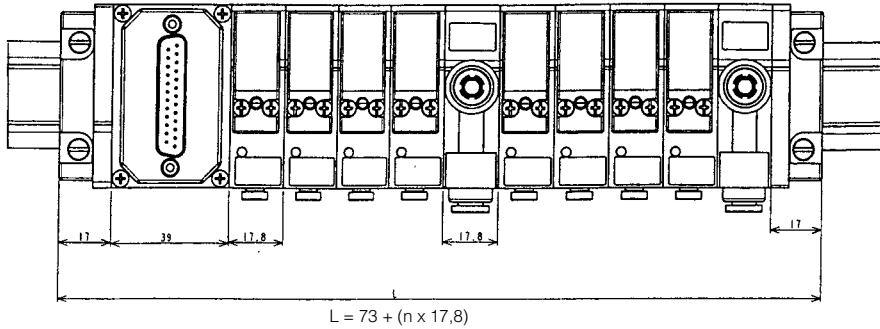

G

n = number of valves

P2S-HA246
 Intermediary air feed module

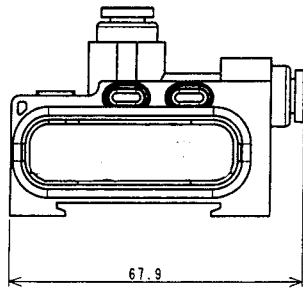

P2S-KW••
 Basic module with Solenoid valve

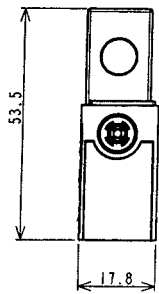
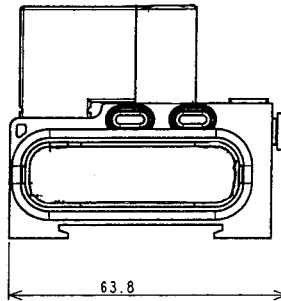
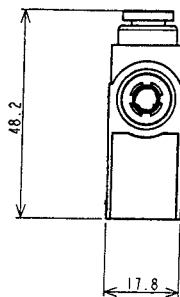

Head modules : **P2S-HA146C13A**
 SubD25

P2S-KA146H20A
 Cable gland

P2S-KA146d25A
 Cylindrical

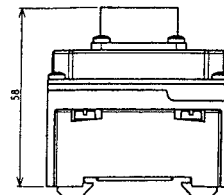
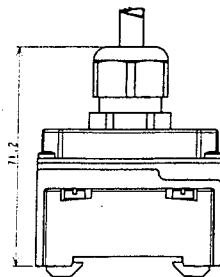
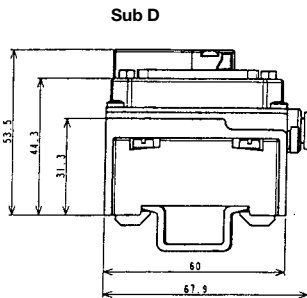

Dimensions, Valvetronic Interface 2000

With Cable gland or SubD25 Connection Island

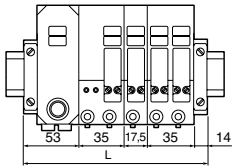

$L = 67 + (m \times 17,5) + (n \times 35)$
 m = number of 3/2 valves
 n = number of 4/2 valves

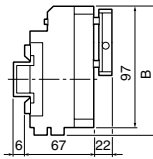
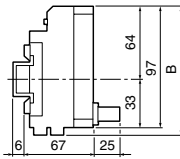

Fitting Ø6
 Fitting Ø8

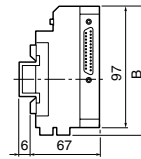

B=105 mm
 B=109 mm

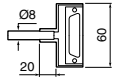

With Industrial Cylindrical Island

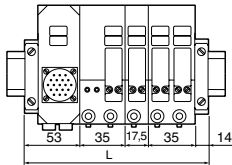

$L = 67 + (m \times 17,5) + (n \times 35)$
 m = number of 3/2 valves
 n = number of 4/2 valves

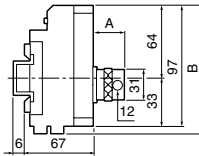

Fitting Ø6 B=105 mm
 Fitting Ø8 B=109 mm

Connector 19 pins A=90 mm
 Cable A=60 mm

Intermediary air supply

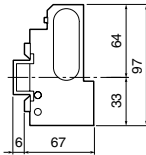

With bus : DeviceNet, Profibus DP, Interbus S, FIPIO, ASI

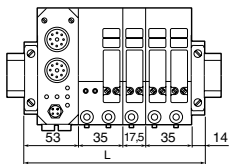

$L = 67 + (m \times 17,5) + (n \times 35)$
 m = number of 3/2 valves
 n = number of 4/2 valves

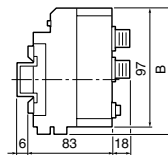

Fitting Ø6 B=105 mm
 Fitting Ø8 B=109 mm

ASI connecting module

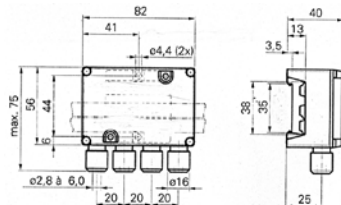

Dimensions, Valvetronic PVL-B10

Uniform configuration $L = 120 + (n \times 18)^*$
 Mixed configuration $L = 142 + (n \times 18)^*$

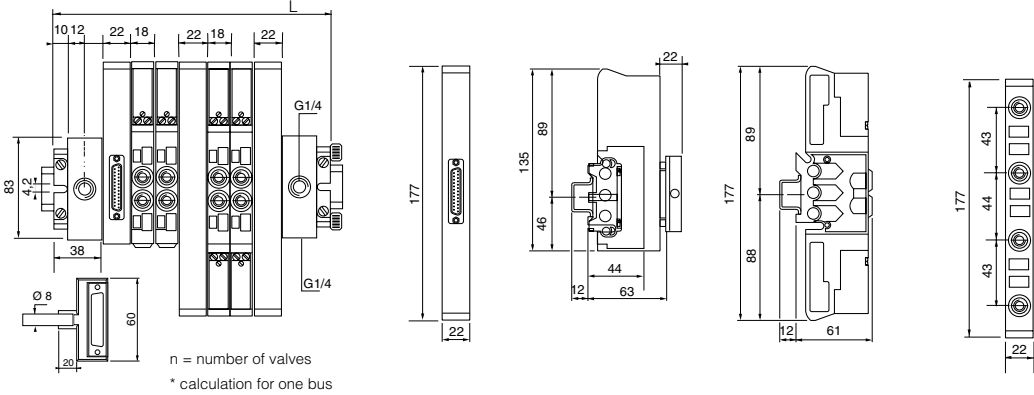

ASI Bus

Uniform configuration $L = 146 + (n \times 18)^*$
 Mixed configuration $L = 168 + (n \times 18)^*$

- | | | |
|-------------------|---------|----------------------|
| Connector 19 pins | a = 90 | b = 31 |
| Connector 35 pins | a = 115 | b = 41 |
| Cable 19 pins | a = 60 | b = 31 |
| Cable 35 pins | a = 70 | b = 41 |
| | | $\varnothing c = 12$ |

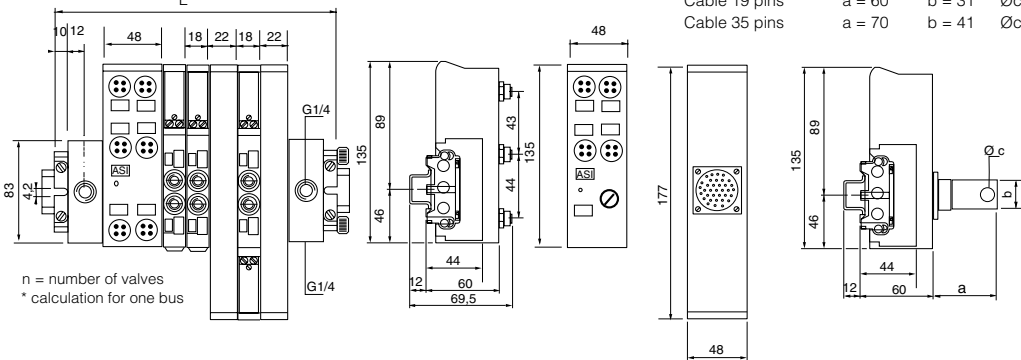

DeviceNet, Profibus DP, Interbus S, FIPIO

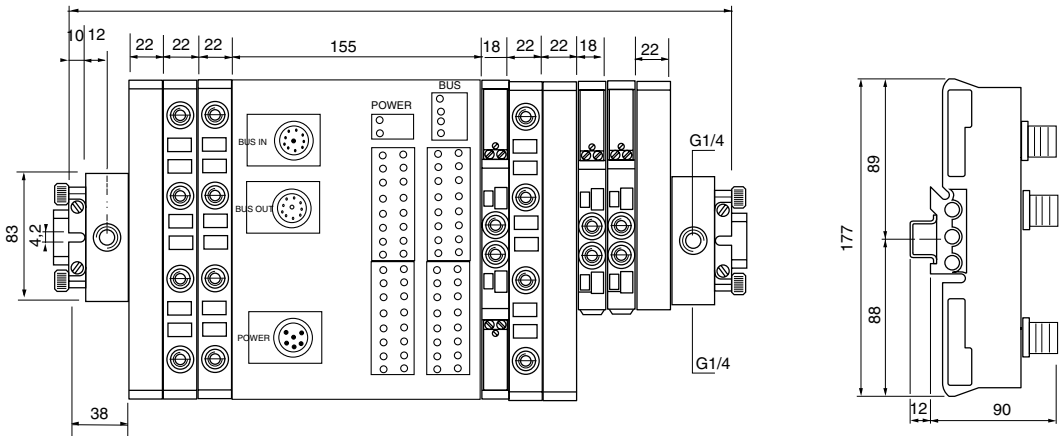

Dimensions, Valvetronic PVL-C10

Head modules : SubD25 connector

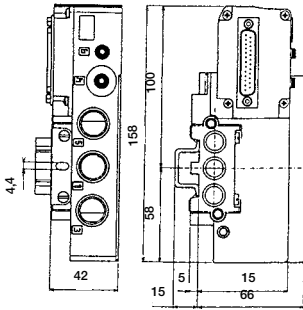

Cylindrical connector

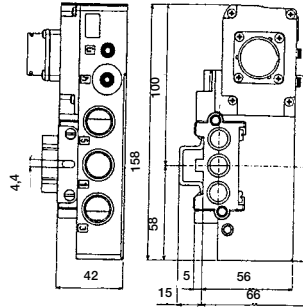

Cable gland

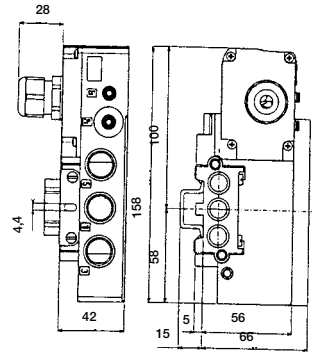

Intermediary air supply module

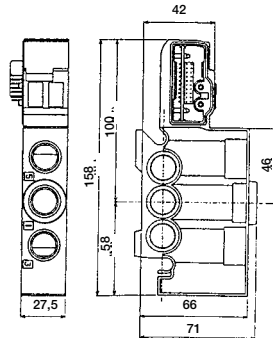

Transfer Module from PVL-B10/PVL-C10 and Head
 ASI bus / Air feed module PVL-C10

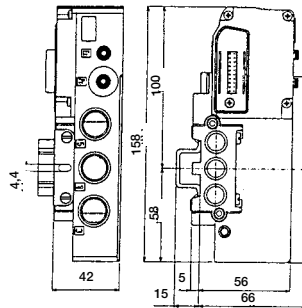

Valve 5/2 monostable

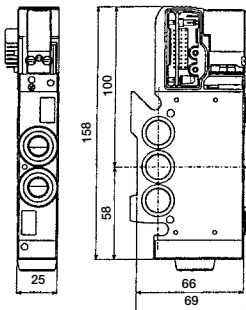

Valve 5/2 bistable - 2x3/2 - 5/3

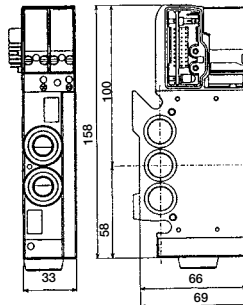

Dimensions, Valvetronic PVL-C10

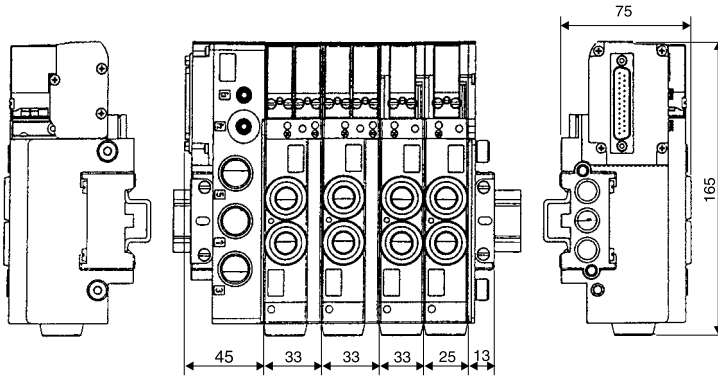

Association PVL-B10 G1/8 and PVL-C10 G1/4

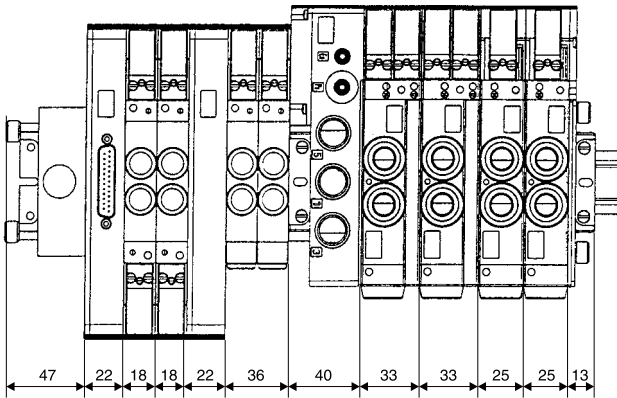

Association ASI and PVL-C10

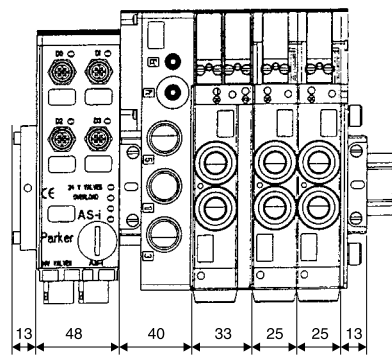

Association ASI and PVL-B10 and PVL-C10

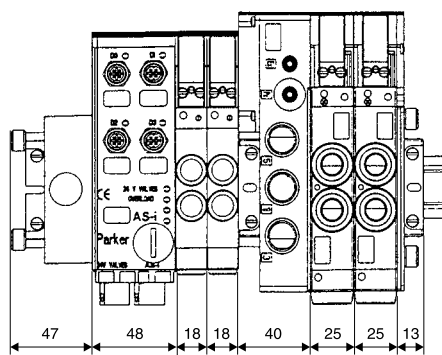

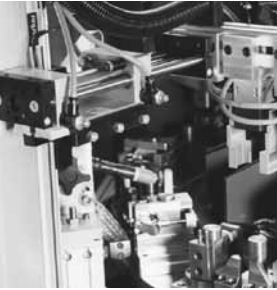

PS1 Modular Interface Valves

High speed poppet valve solenoid type with individual electrical connections. Light weight plastic bodies with DIN rail manifold. For cabinet installation

- Push-in connection
- High Performance 15 mm Solenoid
- Built-in terminal block
- Pneumatic output indicator
- DIN rail mounting

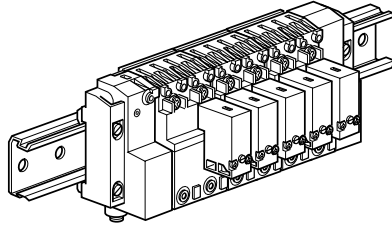

Technical characteristics

		3/2	4/2
Fluid :		Air or inert gas, filtered 40 µ, dry or lubricated	
Working pressure ;		3 to 8 bar	
3/2 and 4/2 Low pressure module		1 to 8 bar	---
Flow rate :		120 Nl/min	
Nominal Qn		200 Nl/min	
Maximum Qmax			
Changeover time :			
Actuation		10 ms	15 ms
Return		15 ms	20 ms
Operating temperature :		- 15 °C to + 60 °C	
Storage temperature :		- 40 °C to + 70 °C	
Vibrations resistance :		2 g at 2 to 150 Hz according to IEC68-2-6	
Impact resistance :		15 g 11 ms according to IEC68-2-27	

Head and tail sets - intermediate supply modules

For 3/2 and 4/2 interface modules

	Description	Characteristics	Pneumatic connection	Weight (g)	Order code
	Set for single air supply connection	1 electrical common terminal 1 main air supply port 1 exhaust port	Push-in Ø 6 mm	100	PS1-E101
			G1/8	100	PS1-E1018
	Set for double air supply connection	1 electrical common terminal 2 main air supply ports 2 exhaust ports	Push-in Ø 6 mm	125	PS1-E102
			G1/8	125	PS1-E1028
	Intermediate air supply module	1 air supply port 1 exhaust port <i>(see description below)</i>	G1/8	45	PS1-E1038

Incorporating an intermediate air supply module into a group of electro-pneumatic modules gives the following options :

Air supply connection

- Additional G1/8 port to supplement the air supply to the manifold
- Blank the common air supply, enabling different pressures to be supplied to groups of modules within the manifold.

Exhaust connection





- Additional exhaust flow through the G1/8 port
- Blank the common exhaust, enabling separation of exhaust from module groups

The intermediate air supply module is supplied with 4 interchangeable connectors to enable the above supply options to be achieved.

Electro-pneumatic modules

Modules without solenoid valve

Visual indication of pneumatic output status : Closed = Red Open = Yellow

Symbol function	Description	Pneumatic connection	Weight (g)	Order code
	3/2 normally closed (NC)	Push-in Ø 4 mm	52	PS1-E111
		M5	55	PS1-E115
		Push-in Ø 6 mm	55	PS1-E116
	3/2 normally open (NO)	Push-in Ø 4 mm	52	PS1-E121
		M5	55	PS1-E125
		Push-in Ø 6 mm	55	PS1-E126
	4/2 single solenoid / spring return	Push-in Ø 4 mm	120	PS1-E191
		M5	120	PS1-E195
		Push-in Ø 6 mm	125	PS1-E196
	4/2 double solenoid	Push-in Ø 4 mm	120	PS1-E181
		M5	120	PS1-E185
		Push-in Ø 6 mm	125	PS1-E186

Low pressure Electro-Pneumatic modules 3/2 (1 to 8 bar)

Modules without solenoid valve

Visual indication of pneumatic output status : Closed = Red Open = Yellow

Symbol	Description	Pneumatic connection	Weight (g)	Order code
	3/2 normally closed (NC)	Push-in Ø 4 mm	52	PS1-E311
		M5	52	PS1-E315
		Push-in Ø 6 mm	52	PS1-E316

Solenoids 15 mm - 8 mm pin spacing - 1,2 W / 1,6 VA

Manual override type	Voltage	Weight (g)	Without	Non locking flush	Locking flush
			Order code	Order code	Order code
	12 VDC	38	P2E-KS32B0	P2E-KS32B1	P2E-KS32B2
	24 VDC	38	P2E-KS32C0	P2E-KS32C1	P2E-KS32C2
	48 VDC	38	P2E-KS32D0	P2E-KS32D1	P2E-KS32D2
	24 VAC 50 Hz	38	P2E-KS31C0	P2E-KS31C1	P2E-KS31C2
	48 VAC 50/60 Hz	38	P2E-KS34D0	P2E-KS34D1	P2E-KS34D2
	115 VAC 50 Hz	38	P2E-KS31F0	P2E-KS31F1	P2E-KS31F2
	220 VAC 50 Hz	38	P2E-KS31J0	P2E-KS31J1	P2E-KS31J2

Suppressor and LED indicators

For 8 mm solenoid pin spacing - For mounting between the solenoid valve and the cable plug

Symbol	Description	Pneumatic connection	Weight (g)	Order code
	LED indicator	24 VAC/DC	3	P8V-CR26C
		48 VAC/DC	3	P8V-CR26D
		115 VAC 50 Hz - 120 VAC 60 Hz	3	P8V-CR24F
		230 VAC 50 Hz - 240 VAC 60 Hz	3	P8V-CR24J

Maintenance avertissement - Solenoid pin spacing







The electro-pneumatic interface modules have been re-designed to accept both 8 mm and 9,4 mm solenoid pin spacing. If you are purchasing a solenoid or a suppressor & LED indicator for maintenance on an electro-pneumatic interface module purchased before June 2004, above solenoid P2E-KS3xxx and P8V-CRxxx (8 mm pin spacing) will not be compatible. Please, contact your Parker customer service.

Electro-pneumatic modules

Modules with solenoid valve

Visual indication of pneumatic output status : Closed = Red Open = Yellow

Symbol	Description	Manual override	Pneumatic connection	Weight (g)	Order code
	3/2 normally closed (NC)	Spring return	Push-in Ø 4 mm	90	PS1-
	3/2 normally open (NO)	Spring return	Push-in Ø 4 mm	90	PS1-E22102B
	4/2 single solenoid / spring return	Spring return	Push-in Ø 4 mm	160	PS1-E28102B
	4/2 double solenoid	-	Push-in Ø 4 mm	200	PS1-

Accessories : Pressure switch

With Ø4 push in connection (pneumatic input)
With electrical terminals 1,5 mm² (electric output)

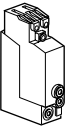
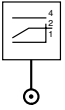
Type	Symbol	Electrical characteristics	Pneumatic characteristics	Override	Weight (g)	Order code
		Pressure switch 1 CO contact 5 A/250 V	Fixed operating threshold < 1,3 bar	Manual override	50	PS1-P1081
			Adjustable operating threshold 2 to 5 bar	Manual override	50	PS1-P1091

Technical characteristics : Pressure switch

- Effective detection for preventing hazardous risks linked with equipments operating at to low pressure
- Manual override
- Easy clip on DIN rail mounting
- Fixed or adjustable threshold versions
- Recessed Electrical Terminals

Electrical durability

	24 VAC	48 VAC	115 VAC	24 VDC	48 VDC	115 VDC
1 million	25 VA	56 VA	115 VA	24 W	37 W	50 W
2 million	-	-	-	14 W	25 W	40 W
5 million	10 VA	14 VA	19 VA	-	-	-

Working pressure	Max 10 bar
Working temperature	-15 °C to +60 °C
Minimum actuating pressure, non adjustable	≤1,3 bar
Minimum actuating pressure, adjustable	2 to 5 bar
Operating frequency	Max 10 Hz
Nominal isolation voltage	660 V AC or DC
Nominal thermal current	10 A
Operating voltage	250 V
Pending current	5 A
Protection level	IP 40
According Power switches (inductive lead)	

Dimensions, PS1 valve Series

Electropneumatic interface modules 3/2 NC or NO

3/2 modules equipped with solenoid
 Head and tail set for single air supply connection

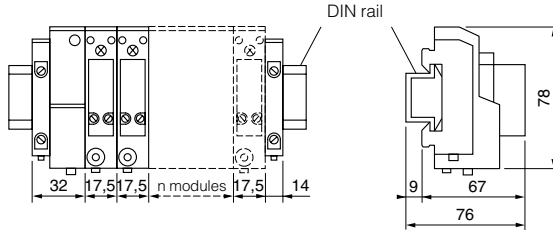

Total length (mm)
 $L = 46 + (n \times 17,5)$
 n = number of modules

3/2 modules equipped with solenoid, suppressor and LED indicator
 Head and tail set for double air supply connection

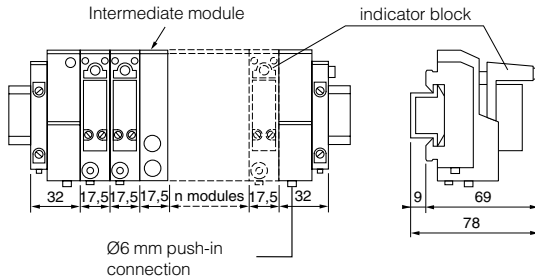

Total length (mm)
 $L = 64 + (n \times 17,5)$
 n = number of modules

Electropneumatic interface modules 4/2 single or double solenoid

4/2 modules equipped with solenoid, suppressor and LED indicator
 Head and tail set for double air supply connection

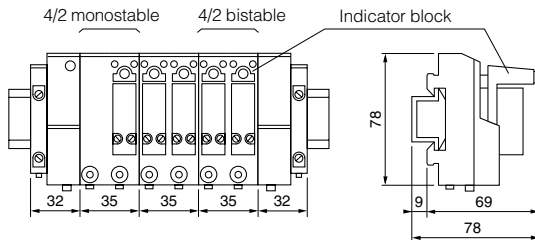

Total length (mm)
 $L = 64 + (n \times 35)$
 n = number of modules



H



PVL-B & PVL-C Inline Valves

Stackable, Stand-alone and Valvetronic

PVL-B size
18 mm width



PVL-C size
25 mm width

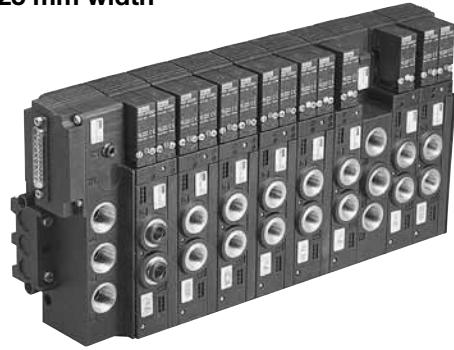

PVL -B12 / -C12

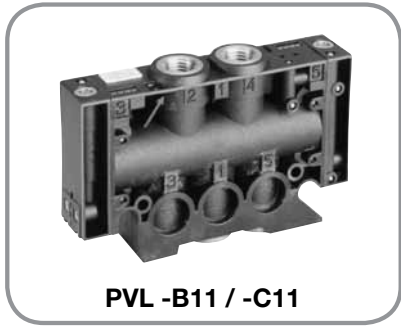

PVL -B11 / -C11

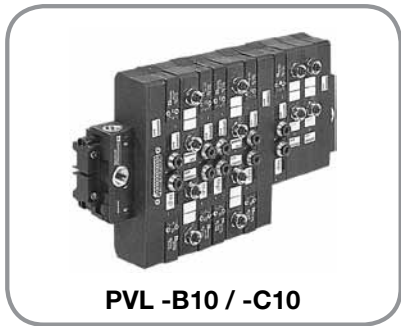

PVL -B10 / -C10

Stackable - Traditional wiring Series

The PVL Series stacking system permits assembly of several valves into one stack. Supply is connected at either a single or a dual head/tail set. Two commons exhaust galleries are provided. Connections to outlet ports 2 and 4 on each valve can be accomplished by threaded pipe or instant tube fittings. Electrical connection is made to each solenoid utilizing a 15 mm - 3 pin - 8 mm spacing connector plug. Each stack assembly can handle any combination of the following valve types :

- Single or double solenoid
- Single or double Remote air Pilot

Both PVL-B & PVL-C valve sizes can be combined in one stack using a transition kit.

Stand- alone Series

Very useful to control isolated cylinders, these stand-alone valve Series are compact and easy to mount on the machines close to the actuator with XXXX electrical or remote pneumatic pilot. Available with solenoid pilots traditional wiring or remote air pilot, these Series can also be stacked and mixed into a stacking valve island Series.

Stackable - Valvetronic Series

Including an integrated electrical connection, the Valvetronic Series allowed a multi-wiring connection. The construction of the stack determines the relationship of each connector pin and the device it is to control. The address of each solenoid valve and each feedback or output connection is based on its physical position in the stack. Electrical Inputs and Outputs can also be added into the Valvetronic device both PVL6B and PVL-C valve sizes can be combined in one stack using a transition kit.

Stacking high flow valves with air pilot or solenoid actuation. Lightweight plastic bodies feature push-in or threaded connections. Stacking valves feature modular inlet and exhaust facility.

- High flow, compact size
- Push-in or threaded connection
- DIN rail or block mounting
- Light weight construction

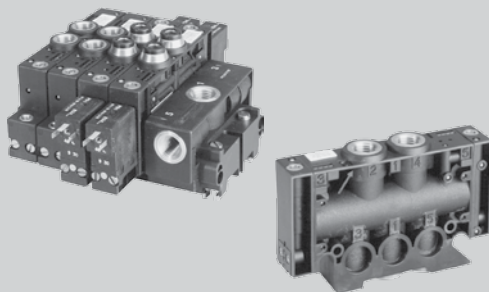

Head and tail sets and intermediate supply modules

Symbol	Type of mounting	Description	Valve size	Port size	Weight (g)	Order code
	On DIN rail	Single air supply head and tail set	PVL-B	G1/4	175	PVL-B1719
			PVL-C	G3/8	195	PVL-C1713
		Dual air supply head and tail set	PVL-B	G1/4	245	PVL-B1729
			PVL-C	G3/8	285	PVL-C1723
	Surface	Single air supply head and tail set	PVL-B	G1/8	175	PVL-B1818
			PVL-C	G1/4	195	PVL-C1819
		Dual air supply head and tail set	PVL-B	G1/8	200	PVL-B1828
			PVL-C	G1/4	225	PVL-C1829
	On DIN rail	Intermediate supply module	PVL-B	G1/8	260	PVU-LBB118
			PVL-C	G1/4	280	PVU-LBB119
	On DIN rail	Kit for stacking PVL-B & PVL-C	PVL-C/B	G1/4-G1/8	640	PVU-LCB119
		Including :				
		- 1 transfert / take-off module				
		- 1 PVL-C head module				
		- 1 PVL-B end plate				







Spare mounting and assembly kits

Symbol	Description	Valve size	Port size	Weight (g)	Order code
	Kit for sealing the inlet/exhaust common gallery including : PVL-C	PVL-B		35	PVL-B1901
	- 3 common blanking plugs - 2 drilled and threaded rods - 2 screws for extended tie rod			65	PVL-C1901
	Pack of 10 common blanking	PVL-B		35	PVL-B1902
		PVL-C		65	PVL-C1902
	Pack of 10 stacking rods	PVL-B		35	PPR-V21
		PVL-C		65	PPR-V22
	Pack of 20 rail clip assembly	PVL-B / PVL-C		-	PPR-L09
	Pack of 30 O-ring seals for common inlet/exhaust ports	PVL-B		-	PPR-V23
		PVL-C		-	PPR-V24

PVL-B & -C valve module for electric low power or air actuator

Valve module without actuator



For use with air-pilot connector or 1,2 W / 1,6 VA solenoid valve

Symbol	Description	Valve size	Connection	Weight (g)	Order code
	5/2 single acting / Spring return	PVL-B	Push-in Ø 6 mm	125	PVL-B121606
			G 1/8	125	PVL-B121618
		PVL-C	Push-in Ø 8 mm	240	PVL-C121608
			G 1/4	240	PVL-C121619
			G 3/8	240	PVL-C121613
			G 1/2	240	PVL-C121614
	5/2 single acting / Air spring return	PVL-B	Push-in Ø 6 mm	125	PVL-B123606
			G 1/8	125	PVL-B123618
		PVL-C	Push-in Ø 8 mm	240	PVL-C123608
			G 1/4	240	PVL-C123619
			G 3/8	240	PVL-C123613
			G 1/2	240	PVL-C123614
	5/2 double acting	PVL-B	Push-in Ø 6 mm	120	PVL-B122606
			G 1/8	120	PVL-B122618
		PVL-C	Push-in Ø 8 mm	230	PVL-C122608
			G 1/4	230	PVL-C122619
			G 3/8	230	PVL-C122613
			G 1/2	230	PVL-C122614
	5/3 APB (All Ports Blocked)	PVL-B	Push-in Ø 6 mm	130	PVL-B127606
			G 1/8	130	PVL-B127618
		PVL-C	Push-in Ø 8 mm	250	PVL-C127608
			G 1/4	250	PVL-C127619
			G 3/8	250	PVL-C127613
			G 1/2	250	PVL-C127614
	5/3 Vented centre	PVL-B	Push-in Ø 6 mm	130	PVL-B128606
			G 1/8	130	PVL-B128618
		PVL-C	Push-in Ø 8 mm	250	PVL-C128608
			G 1/4	250	PVL-C128619
			G 3/8	250	PVL-C128613
			G 1/2	250	PVL-C128614
	Double 3/2 Normally Closed (NC)	PVL-B	Push-in Ø 6 mm	130	PVL-B125606
			G 1/8	130	PVL-B125618

PVL-C valve module for electric high power or air actuator

Valve module without actuator

For use with air-pilot connector or 6 W / 8,5 VA solenoid valve

Symbol	Description	Valve size	Connection	Weight (g)	Order code
	5/2 single acting / Spring return	PVL-C	Push-in Ø 8 mm	250	PVL-C121408
			G 1/4	250	PVL-C121419
	5/2 single acting / Air spring return	PVL-C	Push-in Ø 8 mm	250	PVL-C123408
			G 1/4	250	PVL-C123419
	5/2 double acting	PVL-C	Push-in Ø 8 mm	240	PVL-C122408
			G 1/4	240	PVL-C122419

Each valve module is supplied with two tie rods for use in the "stacking" system.











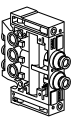

The above valve operator can be either :

- Pneumatic, by adding one or two air pilot connectors including a Ø4 mm push-in fitting or a threaded M5 port ;
- Electric, by adding one or two 1,2 W / 1,6 VA solenoids (PVL-B or C) or 6 W / 8,5 VA (PVL-C).

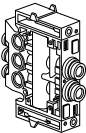
PVL-B & -C valve module for electric low power or air actuator

Valve module without actuator







For use with air-pilot connector or 1,2 W / 1,6 VA solenoid valve

Symbol	Description	Valve size	Connection	Weight (g)	Order code
 	5/2 single acting / Spring return	PVL-B	Push-in Ø 6 mm	125	PVL-B111606
			G 1/8	125	PVL-B111618
	PVL-C	5/2 single acting / Spring return	Push-in Ø 8 mm	240	PVL-C111608
			G 1/4	240	PVL-C111619
		5/2 single acting / Air spring return	G 3/8	240	PVL-C111613
 	5/2 single acting / Air spring return	PVL-B	Push-in Ø 6 mm	125	PVL-B113606
			G 1/8	125	PVL-B113618
	PVL-C	5/2 single acting / Air spring return	Push-in Ø 8 mm	240	PVL-C113608
			G 1/4	240	PVL-C113619
		5/2 double acting	G 3/8	240	PVL-C113613
 	5/2 double acting	PVL-B	Push-in Ø 6 mm	120	PVL-B112606
			G 1/8	120	PVL-B112618
	PVL-C	5/2 double acting	Push-in Ø 8 mm	230	PVL-C112608
			G 1/4	230	PVL-C112619
		5/3 APB (All Ports Blocked)	G 3/8	230	PVL-C112613
 	5/3 APB (All Ports Blocked)	PVL-B	Push-in Ø 6 mm	130	PVL-B117606
			G 1/8	130	PVL-B117618
	PVL-C	5/3 APB (All Ports Blocked)	Push-in Ø 8 mm	250	PVL-C117608
			G 1/4	250	PVL-C117619
		5/3 Vented centre	G 3/8	250	PVL-C117613
 	5/3 Vented centre	PVL-B	Push-in Ø 6 mm	130	PVL-B118606
			G 1/8	130	PVL-B118618
	PVL-C	5/3 Vented centre	Push-in Ø 8 mm	250	PVL-C118608
			G 1/4	250	PVL-C118619
		Double 3/2 Normally Closed (NC)	G 3/8	250	PVL-C118613
 	Double 3/2 Normally Closed (NC)	PVL-B	Push-in Ø 6 mm	130	PVL-B115606
			G 1/8	130	PVL-B115618

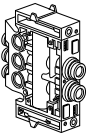
PVL-C valve module for electric high power or air actuator

Valve module without actuator

For use with air-pilot connector or 6 W / 8,5 VA solenoid valve

Symbol	Description	Valve size	Connection	Weight (g)	Order code
 	5/2 single acting / Spring return	PVL-C	Push-in Ø 8 mm	250	PVL-C111408
			G 1/4	250	PVL-C111419
 	5/2 single acting / Air spring return	PVL-C	Push-in Ø 8 mm	250	PVL-C113408
			G 1/4	250	PVL-C113419
 	5/2 double acting	PVL-C	Push-in Ø 8 mm	240	PVL-C112408
			G 1/4	240	PVL-C112419

Each valve module is supplied with two tie rods for use in the "stacking" system.

The above valve operator can be either :

- Pneumatic, by adding one or two air pilot connectors including a Ø4 mm push-in fitting or a threaded M5 port ;
- Electric, by adding one or two 1,2 W / 1,6 VA solenoids (PVL-B or C) or 6 W / 8,5 VA (PVL-C).

Modular piloting system

PVL-B & PVL-C valve module for air-pilot connector or 1,2 W / 1,6 VA solenoid valve

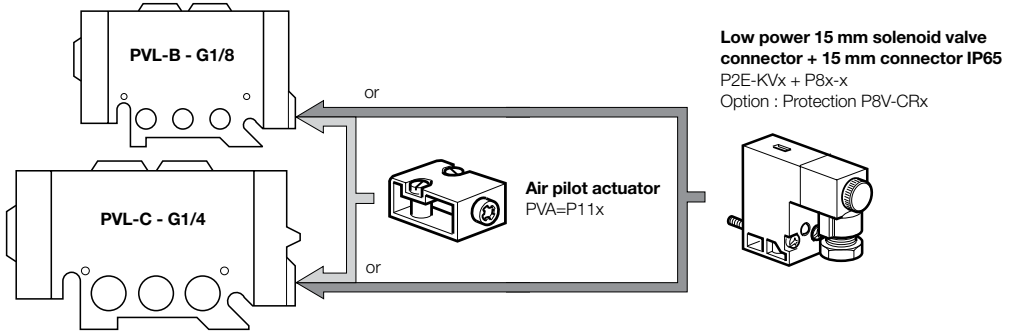

Air-pilot actuator for PVL-B and PVL-C valve

	Description	Pneumatic connection	Weight (g)	Order code
	Air-pilot actuator for PVL-B & PVL-C 15mm solenoid body	Push-in Ø 4 mm	7	PVA-P111
		Threaded M5	2	PVA-P115

Solenoids 15mm 1,2 W / 1,6 VA
(8mm pin spacing)

Description	Voltage	Weight (g)	Manual override	
			Spring return Order code	Indexing Order code
	12 VDC	38	P2E-KV32B1	P2E-KV32B2
	24 VDC	38	P2E-KV32C1	P2E-KV32C2
	48 VDC	38	P2E-KV32D1	P2E-KV32D2
	24 V 50/60Hz	38	P2E-KV31C1	P2E-KV31C2
	48 V 50/60Hz	38	P2E-KV34D1	P2E-KV34D2
	115 V 50Hz, 120 V 60Hz	38	P2E-KV31F1	P2E-KV31F2
	230 V 50Hz, 240 V 60Hz	38	P2E-KV31J1	P2E-KV31J2
Pack of 20 seals	All solenoids	5	-	PPR-V20

Cable plugs 15 mm - IP65
(8mm pin spacing)

Description	Electrical protection	Cable length	Weight (g)	Order code
	No protection	No cable	16	P8C-C
	For inaccessible or recess position	LED + Protection 24 VDC	No cable	16
	No protection	No cable	11	P8C-D
		2 m cable	97	P8L-C2
		5 m cable	228	P8L-C5
	LED + Protection 24 VDC	No cable	11	P8C-D26C
		2 m cable	97	P8L-C226C
		5 m cable	229	P8L-C526C

Modular piloting system

PVL-C valve module for air-pilot connector or 6 W / 8,5 VA solenoid valve

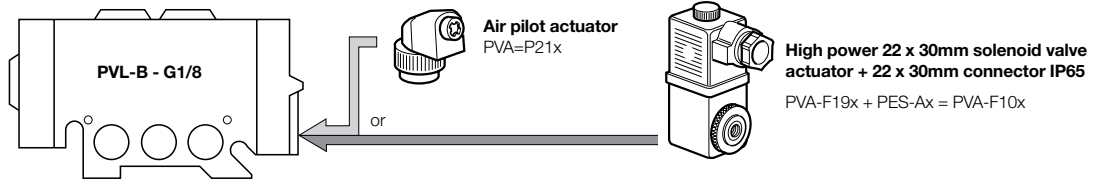



Air-pilot actuator

	Description	Pneumatic connection	Weight (g)	Order code
	Air-pilot actuator for PVL-C 22 x 30 solenoid body	Push-in Ø 4 mm - Elbow	4	PVA-P121
		Push-in Ø 4 mm - Swivel	7	PVA-P122
		Threaded M5	4	PVA-P125
		Pack of 50 O-ring seals	7	PPR-V25

Solenoids 22 X 30 6 W / 8,5 VA Without manual override

	Description	Voltage	Weight (g)	Order code
	Solenoid valve 22 x 30 mm Without cable connector	12 VDC	90	PVA-F192J
		24 VDC	90	PVA-F192B
		48 VDC	90	PVA-F192E
		24 V 50/60Hz	90	PVA-F191B
		48 V 50/60Hz	90	PVA-F191E
		115 V 50Hz, 120 V 60Hz	90	PVA-F191F
		230 V 50Hz, 240 V 60Hz	90	PVA-F191M

Electrical connector 22 x 30 mm

	Description	Electrical protection	Weight (g)	Order code
	Connector to be wired	No protection	25	PES-A10
		LED + Protection 24 V AC/DC	26	PES-A2020B
		LED + Protection 230 V AC	26	PES-A2001M
	Connector with 2 m cable (earth terminal opposite cable)	No protection	150	PES-A12
		LED + Protection 24 V AC/DC	151	PES-A2220B

Solenoids 22 x 30 - 6 W / 8,5 VA - Equipped with cable connector (Without manual override)

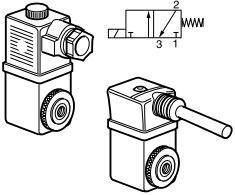
	Description	Voltage	Cable length		
			Without cable Order code	2 meters Order code	5 meters Order code
	Solenoid valve 22 x 30 mm With cable connector	24 VDC	PVA-F102B	PVA-F102B0	PVA-F102B1
		48 VDC	PVA-F102E	PVA-F102E0	PVA-F102E1
		24 V 50/60Hz	PVA-F101B	PVA-F101B0	PVA-F101B1
		48 V 50/60Hz	PVA-F101E	PVA-F101E0	PVA-F101E1
		115 V 50Hz, 120 V 60Hz	PVA-F101F	PVA-F101F0	PVA-F101F1
		230 V 50Hz, 240 V 60Hz	PVA-F101M	PVA-F101M0	PVA-F101M1
		255 V 50Hz	PVA-F101U	PVA-F101U0	PVA-F101U1

*** Version available for use in explosive atmospheres :**

- conforming to certification LCIE 866115 X.
- electrical equipment conforming to harmonised European standards
- marking code EEx II T4 (Consult Technical Sales Office).

EN 500 14 dated March 1977 (NFC23 514 dated May 1982)
EN 500 19 dated March 1977 (NFC23 519 dated May 1982)

- High flow, compact, light weight
- Push-in or threaded pneumatic connections
- High performance 15 mm solenoid DIN 43 650 C
- 2 x 3/2 - 5/2 - 5/3 functions
- Electrical head connection by Sub-D25 or Industrial Cylindrical Connection
- Surface or DIN rail 35 mm mounting

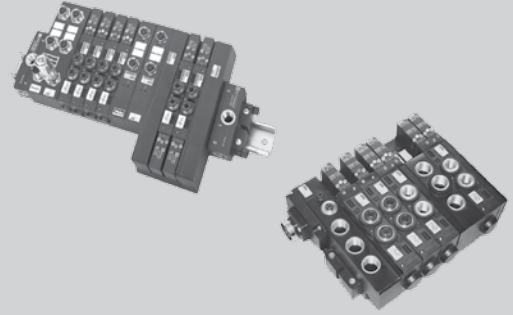

PVL-B10 configurations : Up to 16 valves or 32 I/O maximum

Configuration with single solenoid only

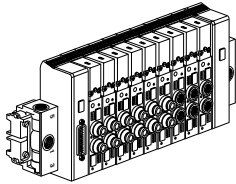

With Sub-D25 or cylindrical 19 pins connector
16 valves or 16 I/O

Configuration with single then double solenoid

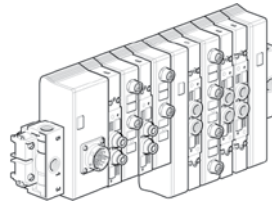

With Sub-D25 or cylindrical 19 pins connector
16 valves or 16 I/O

Configuration with double solenoid only

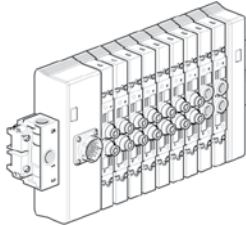

With SubD25 connector
10 valves or 20 I/O

With cylindrical 35 pins connector
16 valves or 32 I/O

Configuration with double then single solenoid

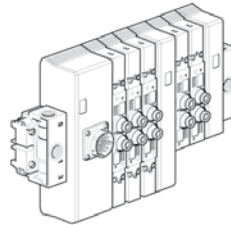

With Sub-D25 connector
16 valves or 21 I/O

With cylindrical 35 pins connector
16 valves or 32 I/O

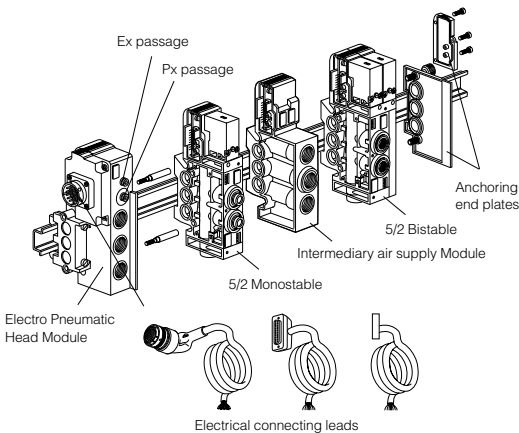

PVL-C10 configurations : Up to 16 valves

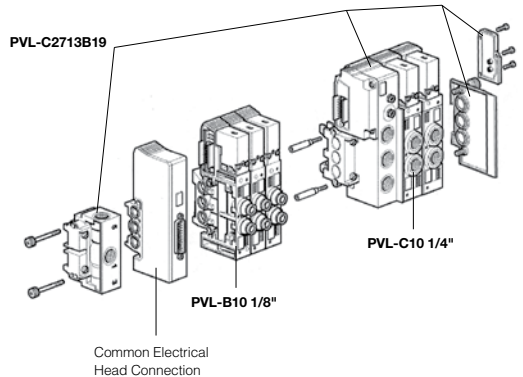

PVL-B10 / PVL-C10 association

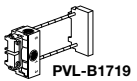
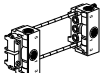
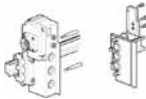
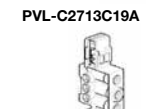

Pneumatic head and tail sets

	Description	External pilot	Mounting	Pneu.Connect.	Valve size	Weight (g)	Order code
	Single air supply	Without PX*	On DIN rail	G1/4	PVL-B10	175	PVL-B1719
			surface	G1/8	PVL-B10	200	PVL-B1818
	Dual air supply	Without PX*	On DIN rail	G1/4	PVL-B10	245	PVL-B1729
			surface	G1/8	PVL-B10	260	PVL-B1828
	HE10 with cable gland	Without PX*		G3/8	PVL-C10	300	PVL-C1713H20A
		With PX*		G3/8	PVL-C10	400	PVL-C2713H20A
	Sub-D25	Without PX*		G3/8	PVL-C10	300	PVL-C1713D25A
		With PX*		G3/8	PVL-C10	400	PVL-C2713D25A
	19 Pins cylindrical connector	Without PX*		G3/8	PVL-C10	350	PVL-C1713C19A
		With PX*		G3/8	PVL-C10	450	PVL-C2713C19A
	Tail air feed module			G3/8	PVL-C10	200	PVU-LC213**
	Intermediary air supply module			G3/8	PVL-C10	200	PVU-LC213E***
	Combination kit for PVL-B10 / PVL-C10	Without PX*		G1/4 & G3/8	PVL-B10 / C10	450	PVL-C1713B19
		With PX*		G1/4 & G3/8	PVL-B10 / C10	460	PVL-C2713B19



Ex = to collect the exhausts of the solenoids

* Px = auxilliary air supply for solenoids, separately from the main valves air supply

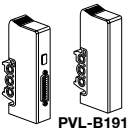
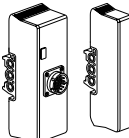

** To be mounted at the end of the valve island for dual air supply (without electrical connections)

*** For dual air supply or different supplies, with no defined location in the valves island (with connections fitted)

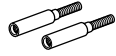

PVL-B10 electric head and tail sets

	Description	Valve configuration	Type of connector	Weight (g)	Order code
	Head and tail sets	Monostable	Sub-D25	220	PVL-B191125
			Cylindrical 19-pins	250	PVL-B191219
		Bistable	Sub-D25	220	PVL-B192125
			Cylindrical 35-pins	250	PVL-B192235
	Head and tail sets	Bistable then monostable	Sub-D25	370	PVL-B194125
			Cylindrical 35-pins	420	PVL-B194235
		Monostable then bistable	Sub-D25	320	PVL-B193125
			Cylindrical 19-pins	350	PVL-B193219
	Transferring module	From bistable to monostable		220	PVL-B1940
		From monostable to bistable		240	PVL-B1930

Spare mounting and assembly kits

	Description	Valve size	Weight (g)	Order code
	Kit for sealing the inlet/exhaust common gallery including : - 3 common blanking plugs - 2 drilled and threaded rods - 2 screws for extended tie rod	PVL-B	35	PVL-B1901
		PVL-C	65	PVL-C1901
		PVL-B	35	PVL-B1902
		PVL-C	65	PVL-C1902
	Pack of 10 stacking rods	PVL-B	35	PPR-V21
		PVL-C	65	PPR-V22
	Pack of 20 rail clip assembly	PVL-B / PVL-C	70	PPR-L09
	Pack of 30 O-ring seals for common inlet/exhaust ports	PVL-B	15	PPR-V23
		PVL-C	15	PPR-V24

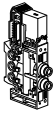
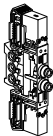
PVL-B10 & PVL-C10 valve module with 24 VDC solenoid pilot equipped

	Symbol	Description	Valve size	Connection	Weight (g)	Order code	
PVL-B10 single solenoid 		Double 3/2 NC (2)	PVL-B10	∅ 6 mm	150	PVL-B10560652B	
				G1/8	150	PVL-B10561852B	
			5/2 single acting Spring return (2)	PVL-B10	∅ 6 mm	125	PVL-B10160652B
					G1/8	125	PVL-B10161852B
				PVL-C10	∅ 8 mm	150	PVL-C10560852B
					G1/4	150	PVL-C10561952B
PVL-B10 double solenoids 		5/2 single acting Internal air return (2)	PVL-B10	∅ 6 mm	125	PVL-B10360652B	
				G1/8	125	PVL-B10361852B	
				PVL-C10	∅ 8 mm	150	PVL-C10360852B
					G1/4	150	PVL-C10361952B
			5/2 double acting (1)	PVL-B10	∅ 6 mm	150	PVL-B10260602B
					G1/8	150	PVL-B10261802B
PVL-C10 single solenoid 		5/3 all ports blocked (1)	PVL-B10	∅ 6 mm	150	PVL-B10760602B	
				G1/8	150	PVL-B10761802B	
				PVL-C10	∅ 8 mm	150	PVL-C10260802B
					G1/4	150	PVL-C10261902B
			5/3 vented center (1)	PVL-B10	∅ 6 mm	150	PVL-B10860602B
					G1/8	150	PVL-B10861802B
PVL-C10 double solenoids 		5/3 pressurized center (1)	PVL-C10	∅ 8 mm	150	PVL-C10860802B	
				G1/4	150	PVL-C10861902B	
				PVL-B10	∅ 6 mm	150	PVL-B10960602B
					G1/8	150	PVL-B10961802B
			PVL-C10	∅ 8 mm	150	PVL-C10960802B	
				G1/4	150	PVL-C10961902B	

(1) With override non locking flush

(2) With override locking flush

PVL-B10 Electrical Input/Output module

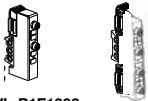
	Description	Type	Connection	Weight (g)	Order code
	Input modules	Monostable	2 Inputs	180	PVL-B1E1302
		Bistable	4 Inputs	240	PVL-B1E2304
PVL-B1E1302 PVL-B1S1302	Output modules	Monostable	2 Outputs	180	PVL-B1S1302
		Bistable	4 Outputs	240	PVL-B1S2304

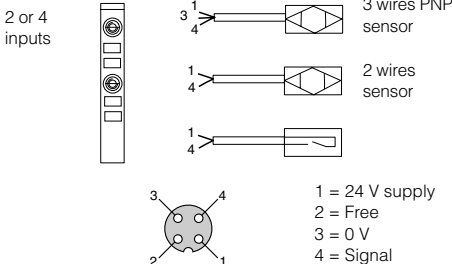

External input module connection

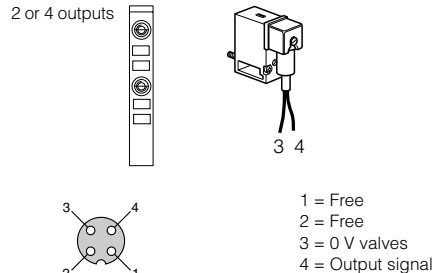

External output module connection

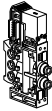
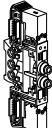

PVL-B10 & PVL-C10 valve module without solenoid pilot

	Symbol	Description	Valve size	Connection	Weight (g)	Electronic circuit board voltage	
						For DC solenoid Order code	For AC solenoid Order code
PVL-B10 single solenoid 		Double 3/2 NC (2)	PVL-B10	∅ 6 mm	150	PVL-B105606W2	PVL-B105606W1
			PVL-C10	G1/8	150	PVL-B105618W2	PVL-B105618W1
		5/2 single solenoid Spring return (2)	PVL-B10	∅ 6 mm	125	PVL-B101606W2	PVL-B101606W1
			PVL-C10	G1/8	125	PVL-B101618W2	PVL-B101618W1
PVL-B10 double solenoids 		5/2 single solenoid Internal air return (2)	PVL-B10	∅ 6 mm	125	PVL-B103606W2	PVL-B103606W1
			PVL-C10	G1/8	125	PVL-B103618W2	PVL-B103618W1
		5/2 double solenoid (1)	PVL-B10	∅ 6 mm	150	PVL-B102606W2	PVL-B102606W1
			PVL-C10	G1/8	150	PVL-B102618W2	PVL-B102618W1
PVL-C10 single solenoid 		5/3 all ports blocked (1)	PVL-B10	∅ 6 mm	150	PVL-B107606W2	PVL-B107606W1
			PVL-C10	G1/8	150	PVL-B107618W2	PVL-B107618W1
		5/3 vented center (1)	PVL-B10	∅ 6 mm	150	PVL-B108606W2	PVL-B108606W1
			PVL-C10	G1/8	150	PVL-B108618W2	PVL-B108618W1
PVL-C10 double solenoids 		5/3 pressurized center (1)	PVL-B10	∅ 6 mm	150	PVL-B109606W2	PVL-B109606W1
			PVL-C10	G1/8	150	PVL-B109618W2	PVL-B109618W1
		5/3 vented center (1)	PVL-B10	∅ 6 mm	150	PVL-B108606W2	PVL-B108606W1
			PVL-C10	G1/8	150	PVL-B108618W2	PVL-B108618W1
			PVL-B10	∅ 6 mm	150	PVL-B109606W2	PVL-B109606W1
			PVL-C10	G1/4	150	PVL-B109619W2	PVL-B109619W1
			PVL-B10	∅ 6 mm	150	PVL-B107606W2	PVL-B107606W1
			PVL-C10	G1/4	150	PVL-B107619W2	PVL-B107619W1
			PVL-B10	∅ 6 mm	150	PVL-B108606W2	PVL-B108606W1
			PVL-C10	G1/4	150	PVL-B108619W2	PVL-B108619W1
			PVL-B10	∅ 6 mm	150	PVL-B109606W2	PVL-B109606W1
			PVL-C10	G1/4	150	PVL-B109619W2	PVL-B109619W1

(1) With override non locking flush
(2) With override locking flush

Solenoids 15 mm 8 mm pin spacing - 1,2 W / 1,6 VA

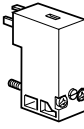
	Voltage	Weight (g)	Manual override type		
			Without Order code	Non locking Flush Order code	Locking Flush Order code
 P2E-KS32C1	12 VDC	38	P2E-KS32B0	P2E-KS32B1	P2E-KS32B2
	24 VDC	38	P2E-KS32C0	P2E-KS32C1	P2E-KS32C2
	48 VDC	38	P2E-KS32D0	P2E-KS32D1	P2E-KS32D2
	24 V 50Hz	38	P2E-KS31C0	P2E-KS31C1	P2E-KS31C2
	48 V 50/60Hz	38	P2E-KS34D0	P2E-KS34D1	P2E-KS34D2
	115 VAC 50Hz	38	P2E-KS31F0	P2E-KS31F1	P2E-KS31F2
	220 VAC 50Hz	38	P2E-KS31J0	P2E-KS31J1	P2E-KS31J2

Maintenance (Solenoid pin spacing)



The electro-pneumatic PVL-B & PVL-C modules have been re-designed to accept both 8 mm and 9,4 mm solenoid pin spacing. If you are purchasing a solenoid for maintenance on an electro-pneumatic interface module purchased before June 2004, above solenoid P2E-KS3xxx (8 mm pin spacing) will not be compatible. Please, contact your Parker customer service.

Spare set of solenoid mounting screws

Type	Material	∅ (mm)	Length (mm)	Weight (g)	Order code
Metric	Steel, passivated	M3	26	20	P2E-KP026PM3*

* Sold by lot of 10 pieces

- Leads and connector (plugged in)
- Protection level IP 65
- Suitable for use across the Valvetronic Modular program
- HE 10 for budget cable gland version
- Sub-D25 for compact version
- Cylindrical 19 or 35 pins for heavy duty industrial

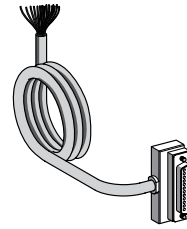

General characteristics

Working temperature	-15 C° to 60 °C
Working current;	
AWG20	5 A
AWG24	2,5 A
AWG28	1 A

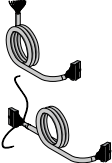

Main data for Connecting leads for Head module with cover gland (HE10)

Type	Connection to valve island	Connection to the control system	Lenght (m)	Weight (g)	Order code
	HE10/HE14	20 coloured wires AWG 24	5,0	510	P8L-MH20A5
	female		9,9	1010	P8L-MH20A9
		HE10 20 pins for direct	1,5	160	P8L-MH20A1BH20A
		plug-in connection on PLC AWG24	3,0	310	P8L-MH20A3BH20A
			5,0	510	P8L-MH20A5BH20A
			9,9	1010	P8L-MH20A9BH20A

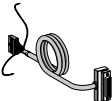
Main data for Connecting leads for Head module with Sub-D25

Type	Connection to valve island	Connection to the control system	Lenght (m)	Weight (g)	Order code
	Leads for head module with Sub-D25	20 coloured wires AWG 24	5,0	540	P8L-MD25A5B
			9,9	1040	P8L-MD25A9B
	Sub-D25 female	25 wires roles flat ribbon AWG 28	15,0	1540	P8L-MD25ACB
			5,0	540	P8L-MD25A5
			9,9	540	P8L-MD25A9
			1,5	160	P8L-MD25A1BH20A
			3,0	310	P8L-MD25A3BH20A
		plug-in connection on PLC	5,0	510	P8L-MD25A5BH20A
			9,9	1010	P8L-MD25A9BH20A

Main data for Connecting leads for Head module with Cylindrical Heavy duty connector

Type	Connection to valve island	Connection to the control system	Lenght (m)	Weight (g)	Order code
	Cylindric connector	19 pins max. Ø cable = 16 mm	To be wired	60	P8C-MC19A
		35 pins max. Ø cable = 22 mm	To be wired	90	P8C-MC35A
	Leads with cylindric	19 coloured wires AWG 20 (16 outputs) max. Ø cable = 12 mm	5,0		P8L-MC19A5
			9,9		P8L-MC19A9
	Connection	35 coloured wires AWG 20 (32 outputs) max. Ø cable = 15 mm	5,0		P8L-MC35A5
			9,9		P8L-MC35A9

Wiring connection for cable gland and Sub-D25 with AWG 24 wire

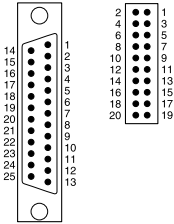

Colour	Input or Output N°	Sub-D25 Pin Nr	HE10 Pin Nr	Colour	Input or Output Nr	Sub-D25 Pin Nr	HE10 Pin Nr
Green	0	13	1	Orange	13	19	14
Tranparent	1	25	2	White	14	6	15
Dark blue	2	12	3	Grey	15	18	16
Light blue	3	24	4	Red/Black	Free	5	17
Pink	4	11	5	Red	24 V	17	17
Purple	5	23	6	Brown	0 V	4	18
Dark green/Black	6	10	7	Black	0 V	16	18
Yellow	7	22	8		16	3	-
Light green/Black	8	9	9		17	15	-
Yellow/black	9	21	10		18	2	-
Blue/Black	10	8	11		19	14	-
White/Black	11	20	12	*	20	1	-
Khaki	12	7	13	* Red wire for flat ribbon cable			

Wiring connection for Sub-D25 with rolled flat ribbon AWG 28 wires

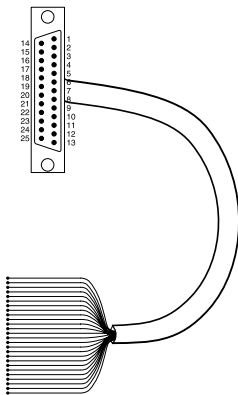

Colour	Nr of Ribbon wires after red wire	Sub-D25 Pin Nr	Input/ Output Nr	Colour	Nr of Ribbon wires after red wire	Sub-D25 Pin Nr	Input/ Output Nr
Grey	24	13	0	Grey	11	19	13
Grey	23	25	1	Grey	10	6	14
Grey	22	12	2	Grey	9	18	15
Grey	21	24	3	Grey	8	5	Free
Grey	20	11	4	Grey	7	17	24 V
Grey	19	23	5	Grey	6	4	0 V Inputs
Grey	18	10	6	Grey	5	16	0V Valves
Grey	17	22	7	Grey	4	3	16
Grey	16	9	8	Grey	3	15	17
Grey	15	21	9	Grey	2	2	18
Grey	14	8	10	Grey	1	14	19
Grey	13	20	11	Red	0 (Red wire)	1	20
Grey	12	7	12				

Wiring connection for cylindrical 19 or 35 pins with AWG 20 wires

I/O Nr	Colour	Connector 19 Pin Nr	Connector 35 Pin Nr	I/O Nr	Colour	Connector 19 Pin Nr	Connector 35 Pin Nr	I/O Nr	Colour	Connector 19 Pin Nr	Connector 35 Pin Nr
0	Pink-Brown	A	A	9	Violet	K	K	18	White-Black	-	V
1	White-Green	B	B	10	Blue	L	L	19	Brown-Blue	-	W
2	White-Yellow	C	C	11	Pink	M	M	20	Brown-Red	-	X
3	White-Grey	D	D	12	Grey	N	N	21	Brown-Black	-	Y
4	White-Pink	E	E	13	Yellow	P	P	22	Grey-Green	-	Z
5	Brown-Green	F	F	14	White	R	R	23	Pink-Green	-	a
6	Red-Blue	G	G	15	Green	S	S	24	Green-Blue	-	b
7	Grey-Pink	H	H	16	White-Blue	-	T	25	Green-Red	-	c
8	Yellow-Brown	J	J	17	White-Red	-	U	26	Green-Black	-	d
								27	Yellow-Grey	-	e
								28	Yellow-Pink	-	f
								29	Yellow-Blue	-	g
								30	Yellow-Red	-	h
								31	Yellow-Black	-	i
									0 V valves Black	T	j
									0 V inputs Brown	U	k
									24 V inputs Red	V	m

Materials :

Body Glass filled polyamide
 Seals Polyurethane
 Fittings Brass

Mounting :

Inline Surface mount on flat surface
 Stacking Mount on 35mm DIN rail or flat surface
 Orientation All positions

Technical characteristics

Description	1/8" Valves PVL-B11 - PVL-B12 - PVL-B10		1/4" Valves PVL-C11 - PVL-C12 - PVL-C10	
	Fluid	Air or inert gas, filtered 40µ, dry or lubricated		
Working pressure	3 to 10 bar	2 to 10 bar	3 to 10 bar	2 to 10 bar
Flow rate	Nominal Qn		1100 NI/mn	
	Maximum Qmax		1800 NI/mn	
— Threaded connector - - - Instant tube fitting PE = Inlet pressure PS = Outlet pressure				
	Valve port size	Instant tube fitting		8mm
	Thread		1/4"	
Head & tail port size	1/4"		3/8"	
Operating temperature	-15°C to +60°C			
Stocking temperature	-40°C to +70°C			
Vibration resistance	2g at 2 to 150 Hz according to IEC68-2-6			
Impact resistance	15g 11ms according to IEC68-2-27			
For air operated valves	Single acting	Double acting	Single acting	Double acting
Pilot pressure (at 6 bar inlet)	3 bar	2 bar	3 bar	2 bar
Depilot pressure (at 6 bar inlet)	1 bar	-	1 bar	-
Response time (Pilot / Return)	15 / 30 ms	12 ms	26 / 60 ms	17 ms
Maximum operating frequency	5 Hz	10 Hz	5 Hz	10 Hz
For 15mm solenoid operated valves	Single acting	Double acting	Single acting	Double acting
Response time (Pilot / Return)	15 / 30 ms	12 ms	26 / 60 ms	17 ms
Maximum operating frequency	5 Hz	10 Hz	5 Hz	10 Hz
Power consumption hold	DC = 1,2 watt / AC = 1,6 VA			
Power consumption inrush	DC = 1,2 watt / AC = 3,5 VA			
Voltage tolerance	+10% / -15% of rated voltage (at 20°C)			
Standard voltage	DC Voltage			
	12 VDC / 24 VDC / 48 VDC			
	AC Voltage			
	24 VAC / 48 VAC / 115 VAC / 230 VAC			
Protection rating	IP65			

Mounting on 35 mm DIN Rail

Valve stacks mount quickly and easily to 35 mm DIN rail with the use of a pneumatic head / tail set. The dual head / tail set provides input and exhaust ports at both ends and is recommended if more than 5 valves are to be operated simultaneously.

Surfacing Mounting

Stacks may be surface mounted by removing the 35 mm DIN mounting hardware on the pneumatic head / tail set.

Removal or Replacement

Modules are removed in reverse of the order shown at right. Before removing a module for service or replacement, loosen the pneumatic tail piece.

Mounting Procedure

1 - Clip on and tighten the pneumatic head piece.



2 - Assemble the two parallel mounting rods using cross rod provided with modules.



3 - Clip on the pneumatic tail piece. Start screws into mounting rod but leave loose for modules insertion.



4 - To mount valves, position upper slot then push-lock lower slot. Mount modules (valves, modules, transition pieces, etc...) and press together.

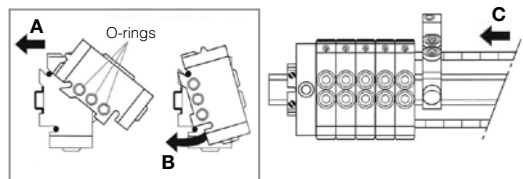

5 - Tighten the assembly.

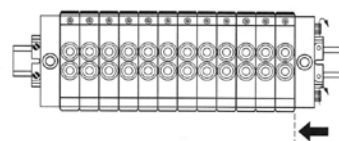

Stand-alone power valves 1/8" without piloting accessories

Monostable PVL-B1116••, PVL-B1136••

Bistable PVL-B1226••

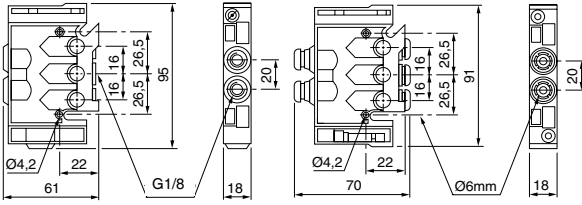

Stacking power valves 1/8" with pneumatic or electrical piloting

Monostable PVL-B1216••, PVL-B1236••

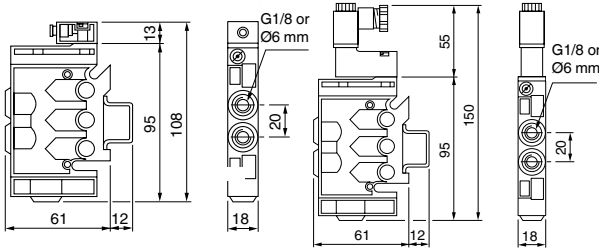

Bistable PVL-B1226••

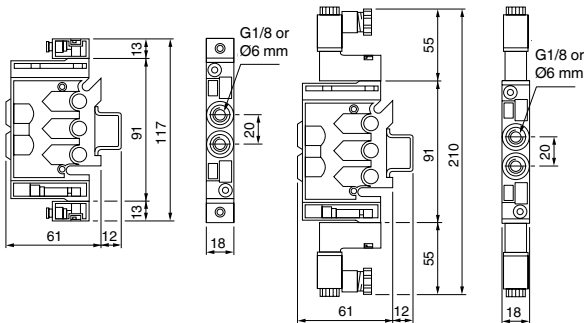

Stand-alone power valves 1/4" without piloting accessories
Monostable PVL-C1116••, PVL-C1136••, PVL-C1114••, PVL-C1134••

Bistable PVL-C1126••, PVL-C1124••

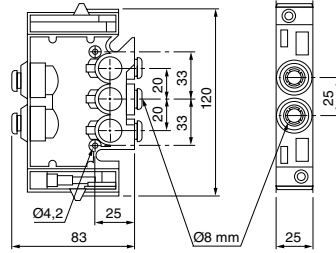
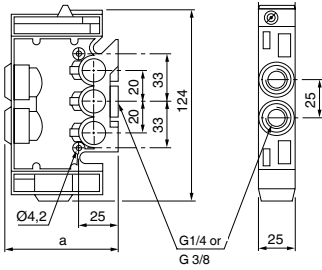

G1/4 G3/8

a 73 88

Stacking power valves 1/4" with pneumatic or electrical control
With 1 W solenoid actuator and suitable pneumatic connector
Monostable PVL-C1216••, PVL-C1236••

Bistable PVL-C1226••

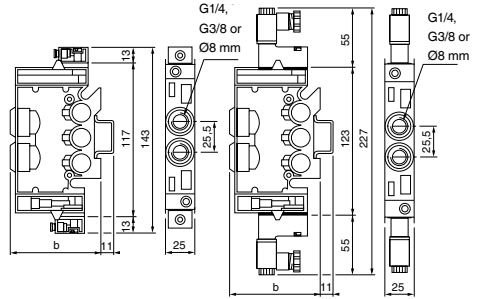
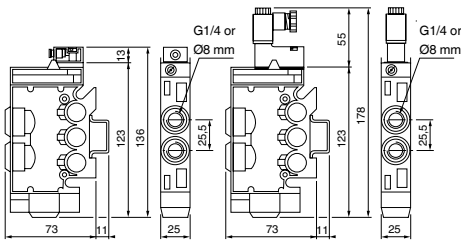

G1/4 G3/8

b 73 77

With 5W solenoid actuator and suitable pneumatic connector
Monostable PVL-C1214••, PVL-C1234••

Bistable PVL-C1224••

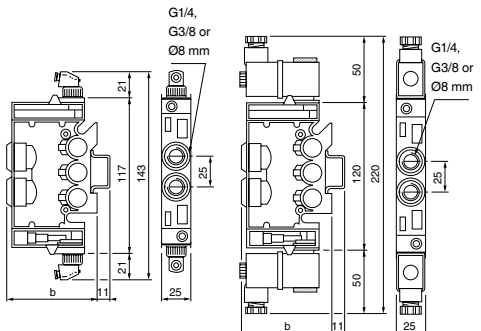
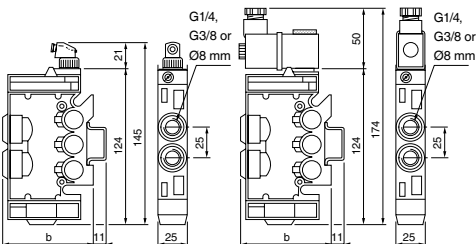

Head and tail sets

Single air supply

PVL-B1719, PVL-C1713, mounting on DIN rail

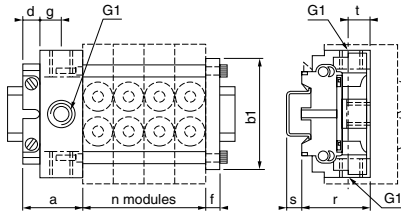

Dual air supply

PVL-B1729, PVL-C1723, mounting on DIN rail

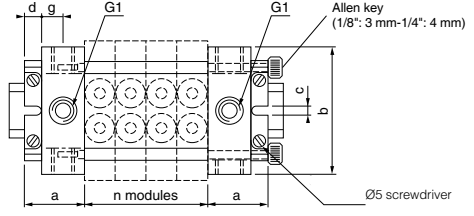

Single air supply

PVL-B1818, PVL-C1819, "stack mounting"

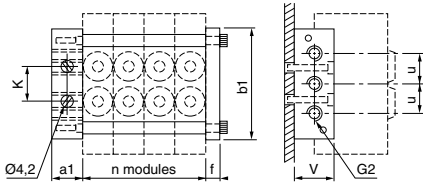

	a	a1	b	b1	c	d	f	g	G1	G2	k	r	s	t	u	v
1/8"	38	16	83	70	4,2	10	8	12	1/4"	1/8"	17,3	44	9	11	16	25
1/4"	38	20	108	100	4,2	10	8	12	3/8"	1/4"	63,5	55	9	13	20	30

"Transfer / take-off" module, intermediate supply module

For combination of sizes 1/4" - 1/8" - PVU-LCB119

PVUL-BB118 - PVU-LCC119

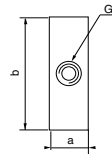
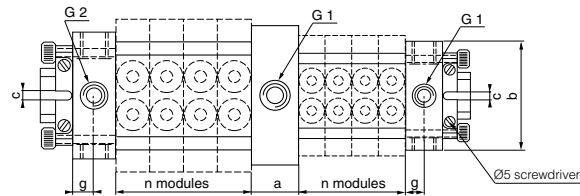

	a	b	G
1/8"	18	75	1/8"
1/4"	25	100	1/4"

Dimensions, Valvetronic PVL-B10

Uniform configuration $L = 120 + (n \times 18)^*$
 Mixed configuration $L = 142 + (n \times 18)^*$

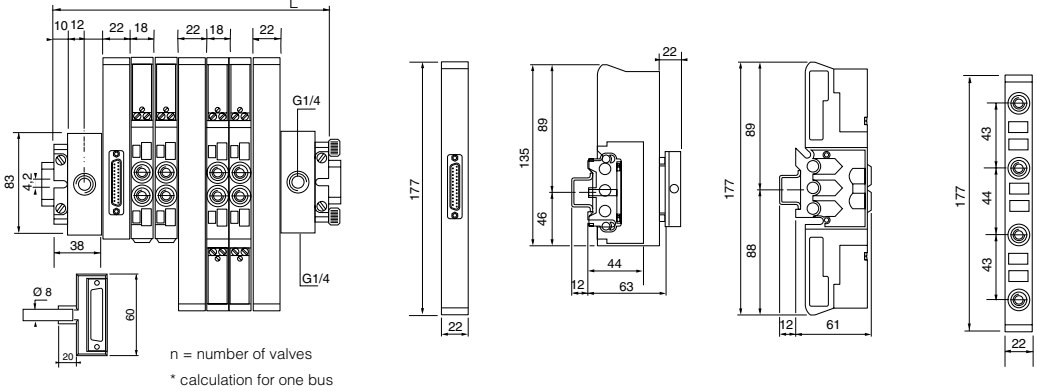

Connector 19 pins	a = 90	b = 31	
Connector 35 pins	a = 115	b = 41	
Cable 19 pins	a = 60	b = 31	Øc = 12
Cable 35 pins	a = 70	b = 41	Øc = 15

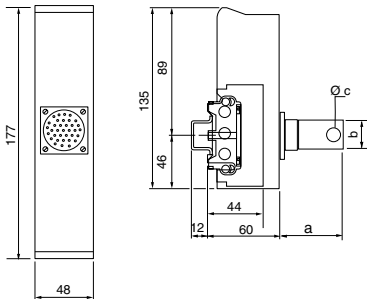

Dimensions, Valvetronic PVL-C10

Head modules : SubD25 connector

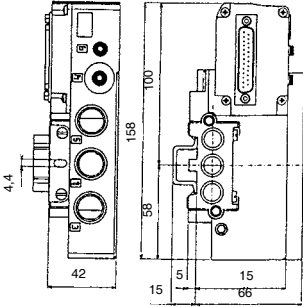

Cylindrical connector

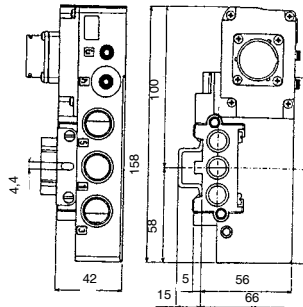

Cable gland

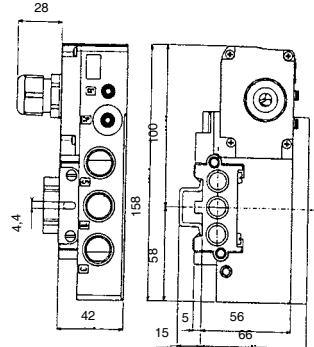

Intermediary air supply module

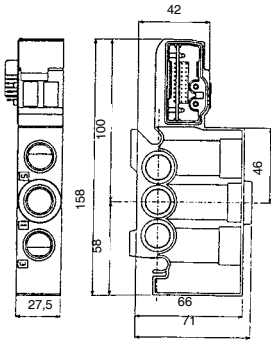

Transfer Module from PVL-B10/PVL-C10 and Head
ASI bus / Air feed module PVL-C10

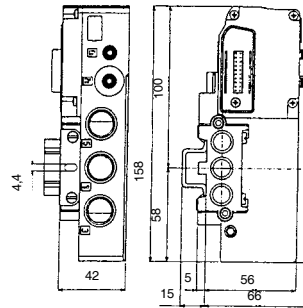

Valve 5/2 monostable

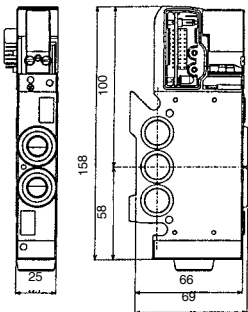

Valve 5/2 bistable - 2x3/2 - 5/3

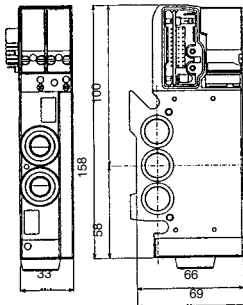

Dimensions, Valvetronic PVL-C10

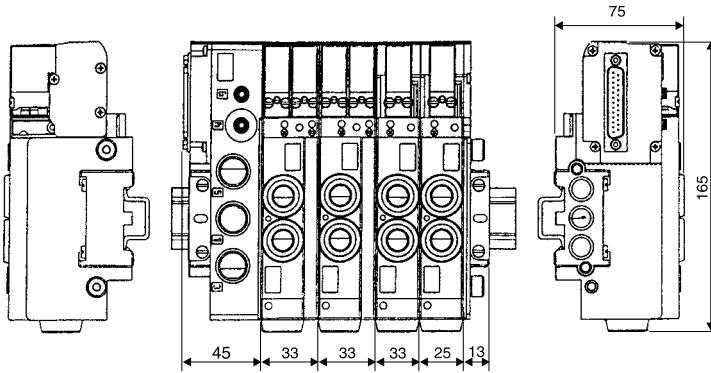

Association PVL-B10 G1/8 and PVL-C10 G1/4

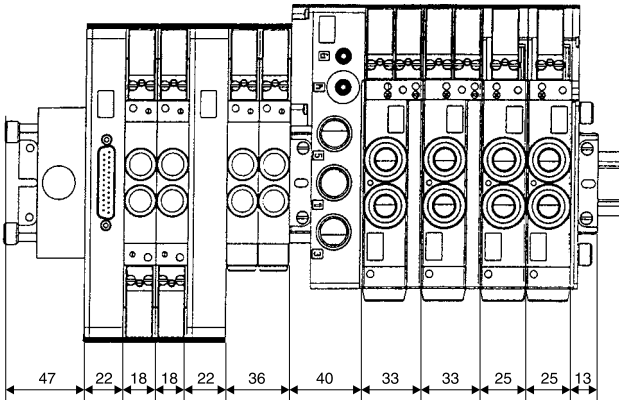





Viking Xtreme Valves

High performance directional
control valves
G1/8, G1/4, G3/8 and G1/2 Body Ported

J

Extreme Environments Demand The Viking Xtreme



The Viking Xtreme valve range is robust, versatile and combines high performance with compact installation dimensions. Large flow capacity, short change-over times and low change-over pressure are important characteristics of this valve range.

The 1/8 & 1/4 sizes are designed to operate with pressures up to 16 bar and the 3/8 & 1/2 sizes up to 12 bar, in ambient temperatures -40°C to +60°C when fitted with suitable solenoid operators.

Viking Xtreme range

- P2LAX, dimension G1/8**
- P2LBX, dimension G1/4**
- P2LCX, dimension G3/8**
- P2LDX, dimension G1/2**

New manually operated valves

The range now includes lever operated versions. They feature a rugged hand lever specifically designed for gloved hands and are available in 5/2 and 5/3 functions

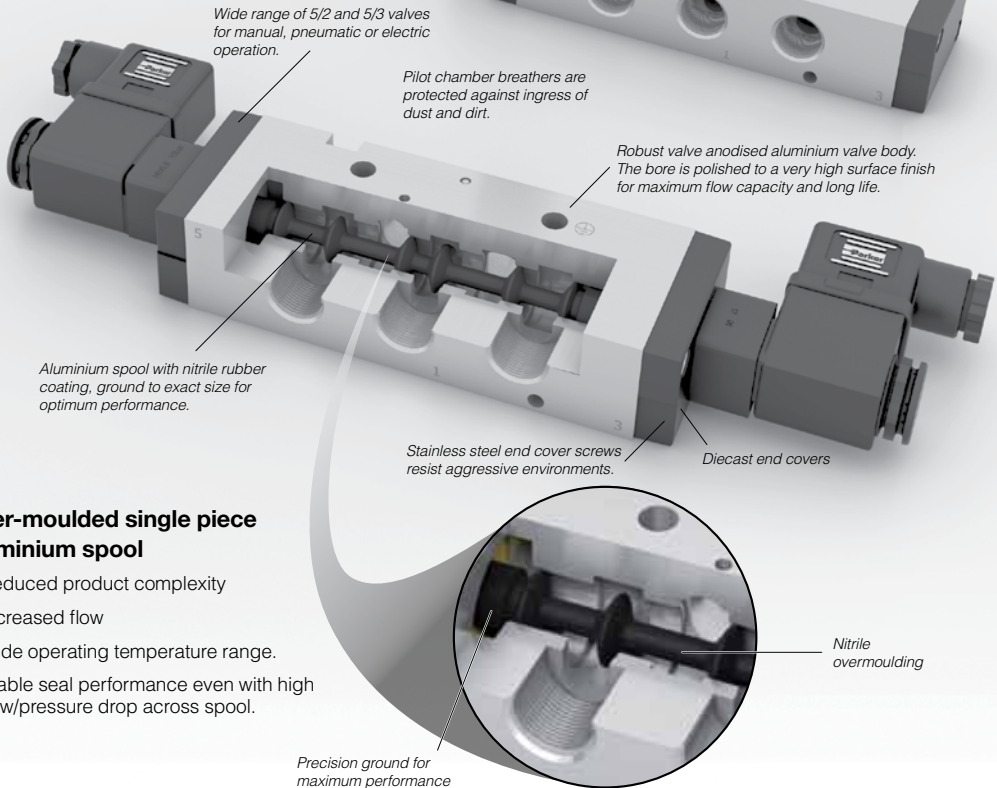

Wide range of 5/2 and 5/3 valves for manual, pneumatic or electric operation.

Pilot chamber breathers are protected against ingress of dust and dirt.

Robust valve anodised aluminium valve body. The bore is polished to a very high surface finish for maximum flow capacity and long life.

Aluminium spool with nitrile rubber coating, ground to exact size for optimum performance.

Stainless steel end cover screws resist aggressive environments.

Diecast end covers

Over-moulded single piece aluminium spool

- Reduced product complexity
- Increased flow
- Wide operating temperature range.
- Stable seal performance even with high flow/pressure drop across spool.

Nitrile overmoulding

Precision ground for maximum performance

Whatever the environment, Push it to the Xtreme



Compact installation dimensions - flexible installation

Compact dimensions direct body porting and integral mounting holes are all features of the Viking Xtreme range. In addition to single valve installation, the Viking valve may be installed on manifolds so that the valves have a common supply and manifolded exhausts.

Mobile applications

The Viking Xtreme valves have a robust body which is machined out of solid aluminium bar and then anodised. Valves have passed aggressive salt spray, and demanding vibration tests and will operate in ambient temperatures of -40°C to $+60^{\circ}\text{C}$. Solenoids are available having wide voltage tolerance for mobile applications.

Maintenance

The Viking Xtreme valve range has been developed from the very successful VGD15 and P2L-A product ranges which have a history of reliable and long service life in demanding and difficult applications. Spares kits are available for the valve and solenoid operators.

Now available in manually operated versions

The range has now been extended to include lever operated versions. The rugged lever actuator has been specifically designed for gloved hands to suit mobile applications in the most arduous of environments. Available in 5/2 and 5/3 functions with either spring return or detented lever and with a choice of mid position function in the 5/3 versions. The lever actuated versions are available across the entire range of port sizes G1/8, G1/4, G3/8 and G1/2.

High reliability

Valves easily comply with the requirements for the component reliability in accordance with EU Machinery Directive standards EN292-2 and EN983.

The Viking Xtreme valves have few moving parts combined with short spool movement, these features combine to give valves having high reliability and long service life. The valves are designed for use with or without supplementary lubrication.

Rust and corrosion resistant designs.

Viking valves are made entirely of anodized aluminium, for good corrosion resistance. The smooth design, with no dirt-collecting pockets, makes the valve suitable for most environments, including applications with stringent hygiene requirements. The valve has stainless steel fixing screws for the end covers, to withstand aggressive environments.

Insensitive to dirty air

Thanks to large flow passage areas and the large flow diameter of 1.0 in the pilot valves, the P2LA and P2LB can be used in normal industrial or mobile environments without any problems of blocking. However the service life of the valve depends on the cleanliness of the air. Please refer to ISO 8573. Valves having ATEX approval
ATEX approved options are available for use in explosive atmospheres. Consult our Technical Sales Department for further information.



Road

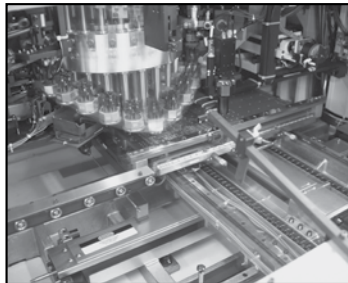

Industrial



Oil & Gas

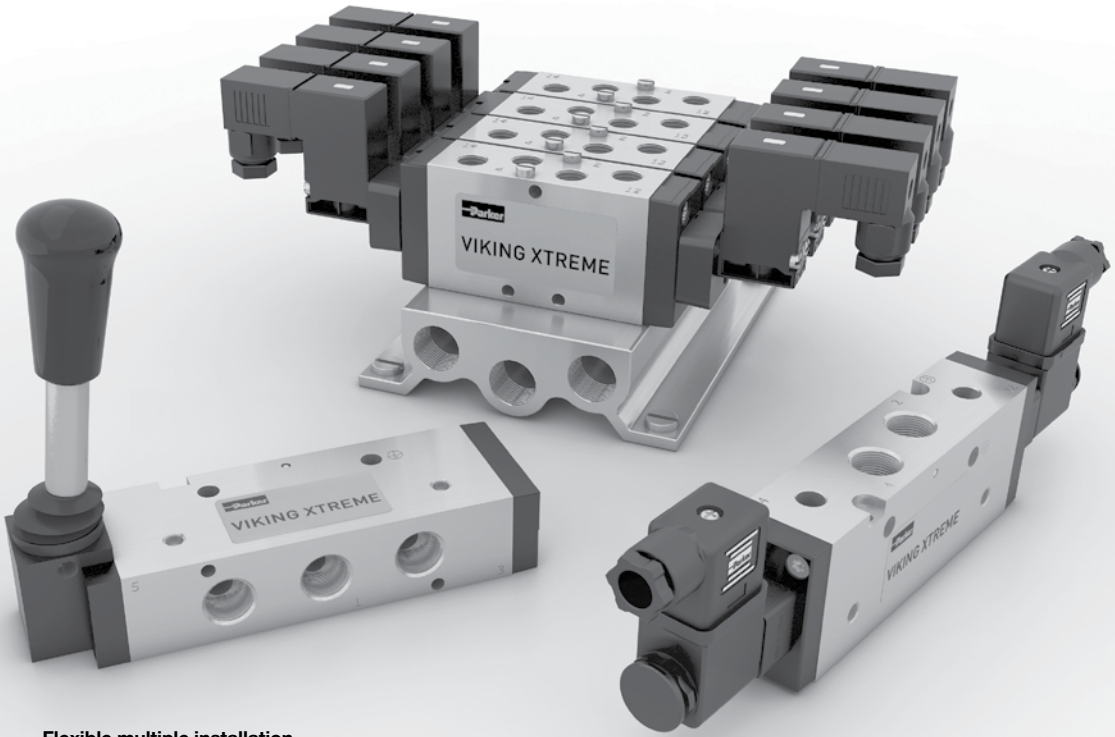

Flexible multiple installation

There is a system of multiple installation plates, intermediate blocks and several variants of connectors for the P2LA. Several variants of connectors are available, which permit connection from above, beneath, straight from the side or in the middle of a valve block. Using the type L manifold, valve blocks may be constructed for supplying several different pressures.

Manifold bar installation

A manifold bar, with common ducts for ports 1, 3 and 5 gives simple, time saving and easily serviced installation. Manifold bars are available in several different sizes, with space for between 2 and 14 valves. They are designed for simple handling and are entirely serviced from the front.

Pressure bar installation

A pressure bar for common primary air supply gives a simple, robust, time saving and easily serviced installation. When pressure bars are used, restrictor-silencers can be installed in the exhaust ports of each valve, for individual adjustment of cylinder/air motor speed. Pressure bars are available in a number of different sizes, with space ranging from 2 to 10 valves.



Rail



Agri-Food



Forestry

J

Working medium, air quality

Working medium: Dry, filtered compressed air to ISO 8573-1 class 3.4.3.

Recommended air quality for valves

For best possible service life and trouble free operation, ISO 8573-1 quality class 3.4.3 should be used. This means 5µm filter (standard filter) dew point +3°C for indoor operation (a lower dew point should be selected for outdoor operation) and oil concentration 1.0 mg oil/m³, which is what a standard compressor with a standard filter gives.

ISO 8573-1 quality classes

Quality class	Pollution		Water max. press. dew point (°C)	Oil max. concentration (mg/m ³)
	particle size (µm)	max. concentration (mg/m ³)		
1	0,1	0,1	-70	0,01
2	1	1	-40	0,1
3	5	5	-20	1,0
4	15	8	+3	5,0
5	40	10	+7	25
6	-	-	+10	-

Typical cylinders speeds which can be achieved with Viking valves and different tube sizes.

In the chart below you can find the suitable valves, tubes etc. for each cylinder size. If you have a tube length over 2 m, choose one tube size larger than in the chart.

Following data is valid:

- Supply pressure : min 7,0 bar
- Regulator pressure setting : 6,0 bar
- Pipe length between air treatment unit and valve : max 1 m
- Pipe length between valve and cylinder : max 2 m

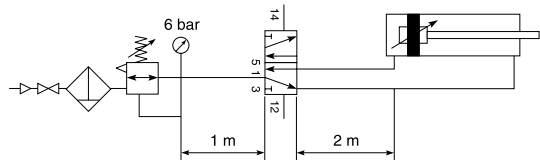

Cylinder bore	<20	20-32	40-50	63	80	100	125	160	200
Cylinder port	M5	G1/8	G1/4	G3/8	G3/8	G1/2	G1/2	G3/4	G3/4
Tubing Ext/Int	4/2.7	6/4	8/6	10/8	10/8	12/9	14/11	18/15	20/18
			6/4	8/6	12/9	14/11			
P2LAX	G1/8	G1/8	G1/8	G1/8	G1/8				
P2LBX	G1/4	G1/4	G1/4	G1/4	G1/4	G1/4			
P2LCX			G3/8	G3/8	G3/8	G3/8	G3/8		
P2LDX				G1/2	G1/2	G1/2	G1/2	G1/2	G1/2

Cylinder speed < 0,5 m/s
 Cylinder speed < 1 m/s

Oversized
 Cylinder speed > 1 m/s

Material specification

P2LAX

Valve

Valve body	Anodised aluminium
End covers	Anodised aluminium
Lever housing	Acetal plastic
Spool	Aluminium + nitrile rubber
Piston	Acetal plastic/ Anodised aluminium
End cover sealings	Nitrile rubber
End cover screws	Stainless steel
Springs	Dacromet® - processed steel, Stainless steel
Lever	Reinforced polyamid plastic
Panel mounting nut	Polycarbonate plastic
Gaiter	Chloroprene rubber
Mounting screws for solenoid	Stainless steel

Accessories

Manifold bar	Anodised aluminium
Pressure bar	Anodised aluminium
Multiple manifolds	Anodised aluminium
End and intermediate blocks	Anodised aluminium

P2LCX

Valve

Valve body	Anodised aluminium
End covers	Anodised aluminium
Spool	Aluminium + nitrile rubber
Piston	Acetal plastic/ Anodised aluminium
End cover sealings	Nitrile rubber
End cover screws	Stainless steel
Springs	Dacromet® - processed steel, Stainless steel
Mounting screws for solenoid	Stainless steel

P2LBX

Valve

Valve body	Anodised aluminium
End covers	Anodised aluminium
Lever housing	Acetal plastic
Spool	Aluminium + nitrile rubber
Piston	Acetal plastic/ Anodised aluminium
End cover sealings	Nitrile rubber
End cover screws	Stainless steel
Springs	Dacromet® - processed steel, Stainless steel
Mounting screws for solenoid	Stainless steel

Accessories

Manifold bar	Anodised aluminium
Pressure bar	Anodised aluminium

P2LDX

Valve

Valve body	Anodised aluminium
End covers	Anodised aluminium
Spool	Aluminium + nitrile rubber
Piston	Acetal plastic/ Anodised aluminium
End cover sealings	Nitrile rubber
End cover screws	Stainless steel
Springs	Dacromet® - processed steel, Stainless steel
Mounting screws for solenoid	Stainless steel

J

Flow characteristics

Flow capacities in accordance with ISO6358
 All pressures = effective pressure
 The curves in the diagram below are typical only

Technical Data P2LAX

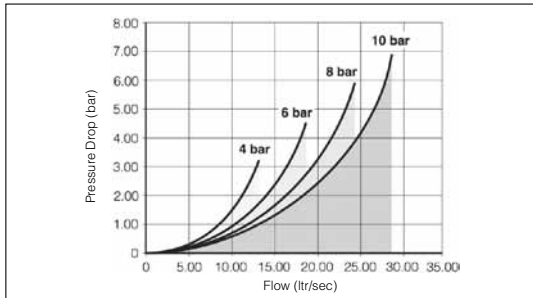

Port size	G1/8
Max operating pressure.	16 bar
Working temperature.	
Air pilot lever solenoid.	-40°C to + 60°C
Standard and food version.	-10°C to + 50°C
Mobile version.	-40°C to + 50°C
Flow (acc. to ISO 6358)	c = 3,0 NI/s x bar b = 0,2 Qn = 11,0 l/s Qmax = 19,0 l/s Cv = 0,65

Technical Data P2LBX

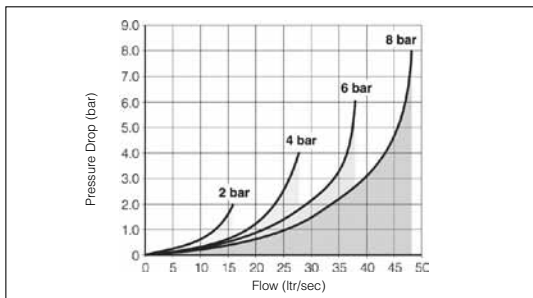

Port size	G1/4
Max operating pressure.	16 bar
Working temperature.	
Air pilot solenoid.	-40°C to + 60°C
Standard and food version.	-10°C to + 50°C
Mobile version.	-40°C to + 50°C
Flow (acc. to ISO 6358)	c = 5,4 NI/s x bar b = 0,2 Qn = 21,5 l/s Qmax = 38,0 l/s Cv = 1,33

Technical Data P2LCX

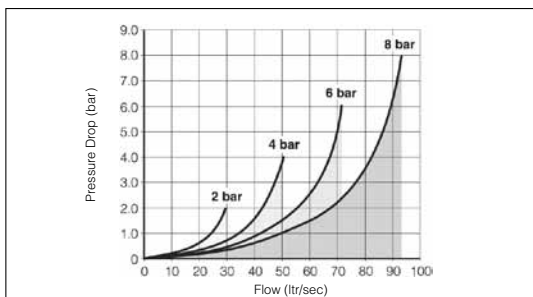

Port size	G3/8
Max operating pressure.	12 bar
Working temperature.	
Air pilot lever solenoid.	-40°C to + 60°C
Air pilot solenoid.	-40°C to + 60°C
Standard and food version.	-10°C to + 50°C
Mobile version.	-40°C to + 50°C
Flow (acc. to ISO 6358)	c = 10,3 NI/s x bar b = 0,22 Qn = 41,0 l/s Qmax = 72,0 l/s Cv = 2,5

Technical Data P2LDX

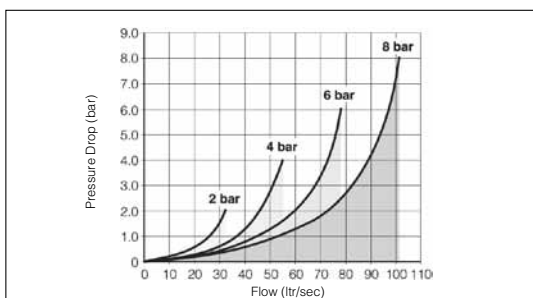

Port size	G1/2
Max operating pressure.	12 bar
Working temperature.	
Air pilot lever solenoid.	-40°C to + 60°C
Air pilot solenoid.	-40°C to + 60°C
Standard and food version.	-10°C to + 50°C
Mobile version.	-40°C to + 50°C
Flow (acc. to ISO 6358)	c = 11,3 NI/s x bar b = 0,3 Qn = 44,3 l/s Qmax = 78 l/s Cv = 2,71

Order chart - Viking Xtreme air pilot & lever valves - Xtreme operating pressure / temperature

<table border="1" style="width: 100%; border-collapse: collapse;"> <tr><td style="text-align: center;">P</td><td style="text-align: center;">2</td><td style="text-align: center;">L</td></tr> </table> <table border="1" style="width: 100%; border-collapse: collapse;"> <tr><td style="width: 20%;"></td><td style="text-align: center;">Valve family</td></tr> <tr><td style="text-align: center;">P2L</td><td>Viking inline valve</td></tr> </table> <table border="1" style="width: 100%; border-collapse: collapse;"> <tr><td style="width: 20%;"></td><td style="text-align: center;">Size</td></tr> <tr><td style="text-align: center;">A</td><td>1/8</td></tr> <tr><td style="text-align: center;">B</td><td>1/4</td></tr> <tr><td style="text-align: center;">C</td><td>3/8</td></tr> <tr><td style="text-align: center;">D</td><td>1/2</td></tr> </table> <table border="1" style="width: 100%; border-collapse: collapse;"> <tr><td style="width: 20%;"></td><td style="text-align: center;">Version</td></tr> <tr><td style="text-align: center;">X</td><td>Xtreme duty spool</td></tr> </table> <p style="font-size: small;">* Xtreme duty spool suitable for max operating pressure 16 bar. (P2LAX + P2LBX) 12 bar (P2LCX + P2LDX) Temperature range -40°C to +60°C</p>	P	2	L		Valve family	P2L	Viking inline valve		Size	A	1/8	B	1/4	C	3/8	D	1/2		Version	X	Xtreme duty spool	<table border="1" style="width: 100%; border-collapse: collapse;"> <tr><td style="text-align: center;">A</td></tr> </table> <table border="1" style="width: 100%; border-collapse: collapse;"> <tr><td style="text-align: center;">X</td></tr> </table> <table border="1" style="width: 100%; border-collapse: collapse;"> <tr><td style="text-align: center;">5</td></tr> </table> <table border="1" style="width: 100%; border-collapse: collapse;"> <tr><td style="text-align: center;">1</td><td style="text-align: center;">1</td></tr> </table> <table border="1" style="width: 100%; border-collapse: collapse;"> <tr><td style="text-align: center;">P</td><td style="text-align: center;">S</td></tr> </table>	A	X	5	1	1	P	S	
P	2	L																												
	Valve family																													
P2L	Viking inline valve																													
	Size																													
A	1/8																													
B	1/4																													
C	3/8																													
D	1/2																													
	Version																													
X	Xtreme duty spool																													
A																														
X																														
5																														
1	1																													
P	S																													
		<table border="1" style="width: 100%; border-collapse: collapse;"> <tr><td style="width: 20%;"></td><td style="text-align: center;">Port thread</td></tr> <tr><td style="text-align: center;">11</td><td>G1/8</td></tr> <tr><td style="text-align: center;">12</td><td>G1/4</td></tr> <tr><td style="text-align: center;">13</td><td>G3/8</td></tr> <tr><td style="text-align: center;">14</td><td>G1/2</td></tr> <tr><td style="text-align: center;">91</td><td>1/8 NPT</td></tr> <tr><td style="text-align: center;">92</td><td>1/4 NPT</td></tr> <tr><td style="text-align: center;">93</td><td>3/8 NPT</td></tr> <tr><td style="text-align: center;">94</td><td>1/2 NPT</td></tr> <tr><td style="text-align: center;">1N</td><td>Namur G1/4</td></tr> <tr><td style="text-align: center;">9N</td><td>Namur 1/4 NPT</td></tr> </table>		Port thread	11	G1/8	12	G1/4	13	G3/8	14	G1/2	91	1/8 NPT	92	1/4 NPT	93	3/8 NPT	94	1/2 NPT	1N	Namur G1/4	9N	Namur 1/4 NPT						
	Port thread																													
11	G1/8																													
12	G1/4																													
13	G3/8																													
14	G1/2																													
91	1/8 NPT																													
92	1/4 NPT																													
93	3/8 NPT																													
94	1/2 NPT																													
1N	Namur G1/4																													
9N	Namur 1/4 NPT																													
		<table border="1" style="width: 100%; border-collapse: collapse;"> <tr><td style="width: 20%;"></td><td style="text-align: center;">Valve type function</td></tr> <tr><td colspan="2" style="text-align: center;">Manual and pneumatic operated</td></tr> <tr><td style="text-align: center;">5</td><td> 5/2 valve</td></tr> <tr><td style="text-align: center;">6</td><td> 5/3 valve closed centre position</td></tr> <tr><td style="text-align: center;">7</td><td> 5/3 valve pressurised centre</td></tr> <tr><td style="text-align: center;">8</td><td> 5/3 valve vented centre</td></tr> </table>		Valve type function	Manual and pneumatic operated		5	5/2 valve	6	5/3 valve closed centre position	7	5/3 valve pressurised centre	8	5/3 valve vented centre																
	Valve type function																													
Manual and pneumatic operated																														
5	5/2 valve																													
6	5/3 valve closed centre position																													
7	5/3 valve pressurised centre																													
8	5/3 valve vented centre																													
		<table border="1" style="width: 100%; border-collapse: collapse;"> <tr><td style="width: 20%;"></td><td style="text-align: center;">Pilot main actuator/return</td></tr> <tr><td style="text-align: center;">P</td><td>Air signal</td></tr> <tr><td style="text-align: center;">S</td><td>Spring (return only)</td></tr> <tr><td style="text-align: center;">V</td><td>Lever, 2 positions, 90° to ports</td></tr> <tr><td style="text-align: center;">1</td><td>Lever, 3 positions self centred, 90° to ports</td></tr> <tr><td style="text-align: center;">2</td><td>Lever, held 3 positions, 90° to ports</td></tr> </table>		Pilot main actuator/return	P	Air signal	S	Spring (return only)	V	Lever, 2 positions, 90° to ports	1	Lever, 3 positions self centred, 90° to ports	2	Lever, held 3 positions, 90° to ports																
	Pilot main actuator/return																													
P	Air signal																													
S	Spring (return only)																													
V	Lever, 2 positions, 90° to ports																													
1	Lever, 3 positions self centred, 90° to ports																													
2	Lever, held 3 positions, 90° to ports																													
		Shaded part numbers are standard																												

J

Pneumatic and lever operated valves - Xtreme operating pressure / temperature

Max operating pressure 16 bar (A & B) 12 bar (C & D). temp range -40°C to +60°C

Symbol	Size	Actuation	Return	Min Operating Pressure (bar)	Changeover time (ms) at 6 bar @20°C actua./return	Weight Kg	Order code
5/2 valves, temperature -40°C to +60°C							
	G1/8	Air signal	Air signal	1,5	5/5	0,14	P2LAX511PP
	G1/4			1,5	6/6	0,30	P2LBX512PP
	G3/8			1,5	8/8	0,45	P2LCX513PP
	G1/2			1,5	9/9	0,45	P2LDX514PP
	G1/8	Air signal	Spring	3,2	8/15	0,15	P2LAX511PS
	G1/4			3,5	10/20	0,32	P2LBX512PS
	G3/8			3,5	10/30	0,45	P2LCX513PS
	G1/2			3,5	10/30	0,45	P2LDX514PS
5/3 valves, temperature -40°C to +60°C							
	G1/8	Air signal	Air signal	3,5	10/20	0,15	P2LAX611PP
	G1/4	Closed centre	Self	3,5	12/22	0,33	P2LBX612PP
	G3/8	position	centring	3,5	15/35	0,50	P2LCX613PP
	G1/2			3,5	15/35	0,50	P2LDX614PP
	G1/8	Air signal	Air signal	3,5	10/20	0,15	P2LAX811PP
	G1/4	Vented centre	Self	3,5	12/22	0,33	P2LBX812PP
	G3/8	position	centring	3,5	15/35	0,50	P2LCX813PP
	G1/2			3,5	15/35	0,50	P2LDX814PP
	G1/8	Air signal	Air signal	3,5	10/20	0,15	P2LAX711PP
	G1/4	Pressurised	Self	3,5	12/22	0,33	P2LBX712PP
	G3/8	centre	centring	3,5	15/35	0,50	P2LCX713PP
	G1/2	position		3,5	15/35	0,50	P2LDX714PP

J

Lever operated directional control valves

Max operating pressure 16 bar (A & B) 12 bar (C & D). temp range -40°C to +60°C

Symbol	Size	Actuation	Return	Changeover angle	Type	Weight Kg	Order code
5/2 valves, standard temperature / Low temperature, lever 90° to ports							
	G1/8	Lever	Lever	28°	Std.	0,18	P2LAX511VV
	G1/4	Lever	Lever	20°	Std.	0,33	P2LBX512VV
	G3/8	Lever	Lever	32°	Std.	0,40	P2LCX513VV
	G1/2	Lever	Lever	32°	Std.	0,60	P2LDX514VV
	G1/8	Lever	Spring	28°	Std.	0,18	P2LAX511VS
	G1/4	Lever	Spring	20°	Std.	0,33	P2LBX512VS
	G3/8	Lever	Spring	32°	Std.	0,40	P2LCX513VS
	G1/2	Lever	Spring	32°	Std.	0,60	P2LDX514VS
5/3 valves, low temperature, lever 90° to ports							
	G1/8	Lever	Lever	±14°	Std.	0,18	P2LAX61122
	G1/4	Closed centre position held in three positions		±12°	Std.	0,33	P2LBX61222
	G3/8		±16°	Std.	0,71	P2LCX61322	
	G1/2		±16°	Std.	0,73	P2LDX61422	
G1/8	Lever		Lever	±14°	Std.	0,18	P2LAX81122
	G1/4	Exhausted centre position held in three positions		±12°	Std.	0,33	P2LBX81222
	G3/8		±16°	Std.	0,71	P2LCX81322	
	G1/2		±16°	Std.	0,73	P2LDX81422	
	G1/8		Lever	Lever	±14°	Std.	0,18
	G1/4	Pressure applied centre position held in three positions		±12°	Std.	0,33	P2LBX71222
	G3/8		±16°	Std.	0,71	P2LCX71322	
	G1/2		±16°	Std.	0,73	P2LDX71422	
	G1/8		Lever	Lever	±14°	Std.	0,18
	G1/4	Closed centre position Self centring		±12°	Std.	0,33	P2LBX61211
	G3/8		±16°	Std.	0,71	P2LCX61311	
	G1/2		±16°	Std.	0,73	P2LDX61411	
	G1/8		Lever	Lever	±14°	Std.	0,18
	G1/4	Exhausted centre position Self centring		±12°	Std.	0,33	P2LBX81211
	G3/8		±16°	Std.	0,71	P2LCX81311	
	G1/2		±16°	Std.	0,73	P2LDX81411	
	G1/8		Lever	Lever	±14°	Std.	0,18
	G1/4	Pressure applied centre position Self centring		±12°	Std.	0,33	P2LBX71211
	G3/8		±16°	Std.	0,71	P2LCX71311	
	G1/2		±16°	Std.	0,73	P2LDX71411	

J

Order chart - Viking Xtreme Normal Operating Pressure / Temperature

P	2	L	A	X	5	1	1	E	S	N	D	D	B	4	9
----------	----------	----------	----------	----------	----------	----------	----------	----------	----------	----------	----------	----------	----------	----------	----------

Valve family	
P2L	Viking inline valve

Size	
A	1/8
B	1/4
C	3/8
D	1/2

Version	
X	Xtreme duty spool

Port thread	
11	G1/8
12	G1/4
13	G3/8
14	G1/2
91	1/8 NPT
92	1/4 NPT
93	3/8 NPT
94	1/2 NPT
1N	Namur G1/4
9N	Namur 1/4 NPT

Solenoïd pilot type	
N	10 bar / -10°C to 50°C
L**	10 bar / -10°C to 50°C

Solenoïd exhaust	
D	Vented
N	Captured/tapped M5
X	15mm solenoïd vented

Valve type function	
Solenoid operated with internal supply to solenoïd	
5	5/2 valve
6	5/3 valve closed centre position
7	5/3 valve pressurised centre
8	5/3 valve vented centre
Solenoid operated with external pilot supply to solenoïds through ports #12 & #14	
N	5/2 valve
P	5/3 valve closed centre position
Q	5/3 valve pressurised centre
R	5/3 valve vented centre

Pilot main actuator / Return	
E	Solenoid operated valve
S	Spring (return only)
P	Press (return only)

Shaded part numbers are standard

Overrides	
A*	None
B*	Flush - non locking
C	Flush - locking
D¹	Extended non-locking
E*	Extended - locking
X	Less 15mm solenoïd

* Only available with enclosure 5
¹ 22mm solenoïd option

Voltage ²			
	AC		DC
	60Hz	50Hz	
40	12		
42	24	22	
45			12
47*			12
48*			24
49			24
53	120	110	
57	240	230	
XX	valve less solenoïd/coil		

² Shaded part numbers are available from stock
 Unshaded part numbers are available on request but will be subject to minimum order quantities
 Otherwise order coil/solenoïd and valve separately.

Solenoïd enclosure / Lead length	
5	15mm, 3 pin Form C/ISO15217 in line
B	with body
N	22mm 3-pin Industrial Form B with coil
X	22mm solenoïd pilot less coil <small>Valve less 15mm solenoïd</small>
L**	Low power 22mm solenoïd (only available with 24V DC)

Solenoid operated directional control valves fitted with 15mm solenoid(s) 24V DC

Solenoid plug/connector to ordered separately.

Internal supply to solenoid valve(s) via port 1. Max operating pressure 10 bar, temp range -10°C to +50°C

Symbol	Size	Actuation	Return	Signal pressure min. (bar) at 6 bar @20°C actua./return	Changeover time (ms) at 6 bar @20°C actua./return	Weight Kg	Order code
5/2 valves, internal air, standard temperature							
	G1/8	Electric signal	Electric signal	1,5/1,5	10/10	0,27	P2LAX511EENXB549
	G1/4			1,5/1,5	22/22	0,42	P2LBX512EENXB549
	G3/8			1,5/1,5	40/40	0,53	P2LCX513EENXB549
	G1/2			1,5/1,5	40/40	0,53	P2LDX514EENXB549
	G1/8	Electric signal	Spring	3,2/-	12/30	0,22	P2LAX511ESNXB549
	G1/4			3,5/-	15/25	0,38	P2LBX512ESNXB549
	G3/8			3,5/-	25/65	0,50	P2LCX513ESNXB549
	G1/2			3,5/-	25/65	0,50	P2LDX514ESNXB549
5/3 valves, internal air, standard temperature							
	G1/8	Electric signal	Electric signal	3,8/-	16/34	0,28	P2LAX611EENXB549
	G1/4	Closed centre	Self	3,8/-	25/30	0,44	P2LBX612EENXB549
	G3/8	position	centring	3,8/-	90/90	0,55	P2LCX613EENXB549
	G1/2			3,8/-	90/90	0,55	P2LDX614EENXB549
	G1/8	Electric signal	Electric signal	3,8/-	16/34	0,28	P2LAX811EENXB549
	G1/4	Vented centre	Self	3,8/-	25/30	0,44	P2LBX812EENXB549
	G3/8	position	centring	3,8/-	90/90	0,55	P2LCX813EENXB549
	G1/2			3,8/-	90/90	0,55	P2LDX814EENXB549
	G1/8	Electric signal	Electric signal	3,8/-	16/34	0,28	P2LAX711EENXB549
	G1/4	Pressurised	Self	3,8/-	25/30	0,44	P2LBX712EENXB549
	G3/8	centre	centring	3,8/-	90/90	0,55	P2LCX713EENXB549
	G1/2	position		3,8/-	90/90	0,55	P2LDX714EENXB549

Solenoid operated directional control valves fitted with adapter to accept 15mm solenoid(s)

Solenoid operator(s) and connector/plug(s) should be ordered separately.







Internal supply to solenoid valve(s) via port 1. Max operating pressure 10 bar, temp range -10°C to +50°C

Symbol	Size	Actuation	Return	Signal pressure min. (bar) at 6 bar @20°C actua./return	Changeover time (ms) at 6 bar @20°C actua./return	Weight Kg	Order code
5/2 valves, internal air, standard temperature							
	G1/8	Electric signal	Electric signal	1,5/1,5	10/10	0,27	P2LAX511EENXXX
	G1/4			1,5/1,5	22/22	0,42	P2LBX512EENXXX
	G3/8			1,5/1,5	40/40	0,45	P2LCX513EENXXX
	G1/2			1,5/1,5	40/40	0,45	P2LDX514EENXXX
	G1/8	Electric signal	Spring	3,2/-	12/30	0,22	P2LAX511ESNXXX
	G1/4			3,5/-	15/25	0,38	P2LBX512ESNXXX
	G3/8			3,5/-	25/65	0,42	P2LCX513ESNXXX
	G1/2			3,5/-	25/65	0,42	P2LDX514ESNXXX
	G1/8	Electric signal	Air signal	1,5/1,5	10/6	0,22	P2LAX511EPNXXX
	G1/4			1,5/1,5	22/10	0,38	P2LBX512EPNXXX
	G3/8			1,5/1,5	22/10	0,76	P2LCX513EPNXXX
	G1/2			1,5/1,5	25/40	0,80	P2LDX514EPNXXX
5/3 valves, internal air, standard temperature							
	G1/8	Electric signal	Electric signal	3,8/-	16/34	0,28	P2LAX611EENXXX
	G1/4	Closed centre	Self	3,8/-	25/30	0,44	P2LBX612EENXXX
	G3/8	position	centring	3,8/-	90/90	0,55	P2LCX613EENXXX
	G1/2			3,8/-	90/90	0,55	P2LDX614EENXXX
	G1/8	Electric signal	Electric signal	3,8/-	16/34	0,28	P2LAX811EENXXX
	G1/4	Vented centre	Self	3,8/-	25/30	0,44	P2LBX812EENXXX
	G3/8	position	centring	3,8/-	90/90	0,55	P2LCX813EENXXX
	G1/2			3,8/-	90/90	0,55	P2LDX814EENXXX
	G1/8	Electric signal	Electric signal	3,8/-	16/34	0,28	P2LAX711EENXXX
	G1/4	Pressurised	Self	3,8/-	25/30	0,44	P2LBX712EENXXX
	G3/8	centre	centring	3,8/-	90/90	0,55	P2LCX713EENXXX
	G1/2	position		3,8/-	90/90	0,55	P2LDX714EENXXX

Solenoid operated directional control valves fitted with adapter to accept 15mm solenoid(s)

Solenoid operator(s) and connector/plug(s) should be ordered separately.





External supply to solenoid valve(s) via ports 12 & 14. Max operating pressure 10 bar, temp range -10°C to +50°C

Symbol	Size	Actuation	Return	Signal pressure min. (bar) at 6 bar @20°C actua./return	Changeover time (ms) at 6 bar @20°C actua./return	Weight Kg	Order code
5/2 valves, external air, standard temperature							
	G1/8	Electric signal	Electric signal	1,5/1,5	10/10	0,19	P2LAXN11EENXXX
	G1/4			1,5/1,5	22/22	0,34	P2LBXN12EENXXX
	G3/8			1,5/1,5	40/40	0,45	P2LCXN13EENXXX
	G1/2			1,5/1,5	40/40	0,45	P2LDXN14EENXXX
	G1/8	Electric signal	Spring	3,2/-	12/30	0,18	P2LAXN11ESNXXX
	G1/4			3,5/-	15/25	0,34	P2LBXN12ESNXXX
	G3/8			3,5/-	25/65	0,42	P2LCXN13ESNXXX
	G1/2			3,5/-	25/65	0,42	P2LDXN14ESNXXX
	G1/8	Electric signal	Air signal	1,5/1,5	10/10	0,19	P2LAXN11EPNXXX
	G1/4			1,5/1,5	22/22	0,34	P2LBXN12EPNXXX
	G3/8			1,5/1,5	40/40	0,45	P2LCXN13EPNXXX
	G1/2			1,5/1,5	40/40	0,45	P2LDXN14EPNXXX
5/3 valves, external air, standard temperature							
	G1/8	Electric signal	Electric signal	3,8/-	16/34	0,20	P2LAXP11EENXXX
	G1/4	Closed centre	Self	3,8/-	25/30	0,36	P2LBXP12EENXXX
	G3/8	position	centring	3,8/-	90/90	0,55	P2LCXP13EENXXX
	G1/2			3,8/-	90/90	0,55	P2LDXP14EENXXX
	G1/8	Electric signal	Electric signal	3,8/-	16/34	0,20	P2LAXR11EENXXX
	G1/4	Vented centre	Self	3,8/-	25/30	0,36	P2LBXR12EENXXX
	G3/8	position	centring	3,8/-	90/90	0,55	P2LCXR13EENXXX
	G1/2			3,8/-	90/90	0,55	P2LDXR14EENXXX
	G1/8	Electric signal	Electric signal	3,8/-	16/34	0,20	P2LAXQ11EENXXX
	G1/4	Pressurised	Self	3,8/-	25/30	0,36	P2LBXQ12EENXXX
	G3/8	centre	centring	3,8/-	90/90	0,55	P2LCXQ13EENXXX
	G1/2	position		3,8/-	90/90	0,55	P2LDXQ14EENXXX

Solenoid operated directional control valves fitted with 22mm solenoid(s) 24V DC







Solenoid plug/connector to be ordered separately.

Internal supply to solenoid valve(s) via port 1. Max operating pressure 10 bar, Temperature range -10°C to +50°C

Symbol	Size	Actuation	Return	Signal pressure min. (bar) at 6 bar @20°C actua./return	Changeover time (ms) at 6 bar @20°C actua./return	Weight Kg	Order code
5/2 valves, internal air, standard temperature							
	G1/8	Electric signal	Electric signal	1,5/1,5	10/10	0,27	P2LAX511EENDDB49
	G1/4			1,5/1,5	22/22	0,42	P2LBX512EENDDB49
	G3/8			1,5/1,5	40/40	0,81	P2LCX513EENDDB49
	G1/2			1,5/1,5	40/40	0,81	P2LDX514EENDDB49
	G1/8	Electric signal	Spring	3,2/-	12/30	0,22	P2LAX511ESNDDB49
	G1/4			3,5/-	15/25	0,38	P2LBX512ESNDDB49
	G3/8			3,5/-	25/65	0,76	P2LCX513ESNDDB49
	G1/2			3,5/-	25/65	0,76	P2LDX514ESNDDB49
5/3 valves, internal air, standard temperature							
	G1/8	Electric signal	Electric signal	3,8/-	16/34	0,28	P2LAX611EENDDB49
	G1/4	Closed centre	Self	3,8/-	25/30	0,44	P2LBX612EENDDB49
	G3/8	position	centring	3,8/-	90/90	1,11	P2LCX613EENDDB49
	G1/2			3,8/-	90/90	1,11	P2LDX614EENDDB49
	G1/8	Electric signal	Electric signal	3,8/-	16/34	0,28	P2LAX811EENDDB49
	G1/4	Vented centre	Self	3,8/-	25/30	0,44	P2LBX812EENDDB49
	G3/8	position	centring	3,8/-	90/90	1,11	P2LCX813EENDDB49
	G1/2			3,8/-	90/90	1,11	P2LDX814EENDDB49
	G1/8	Electric signal	Electric signal	3,8/-	16/34	0,28	P2LAX711EENDDB49
	G1/4	Pressurised	Self	3,8/-	25/30	0,44	P2LBX712EENDDB49
	G3/8	centre	centring	3,8/-	90/90	1,11	P2LCX713EENDDB49
	G1/2	position		3,8/-	90/90	1,11	P2LDX714EENDDB49

Solenoid operated directional control valves (supplied with 22mm solenoid operator less coil)

Internal supply to solenoid valve(s) via port 1.

Symbol	Size	Actuation	Return	Signal pressure min. (bar) at 6 bar @20°C actua./return	Changeover time (ms) at 6 bar @20°C actua./return	Weight Kg	Order code
5/2 valves, internal air, standard temperature							
	G1/8	Electric signal	Electric signal	1,5/1,5	10/10	0,16	P2LAX511EENDDN
	G1/4			1,5/1,5	22/22	0,31	P2LBX512EENDDN
	G3/8			1,5/1,5	40/40	0,41	P2LCX513EENDDN
	G1/2			1,5/1,5	40/40	0,41	P2LDX514EENDDN
	G1/8	Electric signal	Spring	3,2/-	12/30	0,16	P2LAX511ESNDDN
	G1/4			3,5/-	15/25	0,31	P2LBX512ESNDDN
	G3/8			3,5/-	25/65	0,40	P2LCX513ESNDDN
	G1/2			3,5/-	25/65	0,40	P2LDX514ESNDDN
	G1/8	Electric signal	Air signal	1,5/1,5	10/6	0,16	P2LAX511EPNDDN
	G1/4			1,5/1,5	22/10	0,31	P2LBX512EPNDDN
	G3/8			1,5/1,5	25/40	0,40	P2LCX513EPNDDN
	G1/2			1,5/1,5	25/40	0,40	P2LDX514EPNDDN
5/3 valves, internal air, standard temperature							
	G1/8	Electric signal	Electric signal	3,8/-	16/34	0,17	P2LAX611EENDDN
	G1/4	Closed centre	Self	3,8/-	25/30	0,33	P2LBX612EENDDN
	G3/8	position	centring	3,8/-	90/90	1,00	P2LCX613EENDDN
	G1/2			3,8/-	90/90	1,00	P2LDX614EENDDN
	G1/8	Electric signal	Electric signal	3,8/-	16/34	0,17	P2LAX811EENDDN
	G1/4	Vented centre	Self	3,8/-	25/30	0,33	P2LBX812EENDDN
	G3/8	position	centring	3,8/-	90/90	1,00	P2LCX813EENDDN
	G1/2			3,8/-	90/90	1,00	P2LDX814EENDDN
	G1/8	Electric signal	Electric signal	3,8/-	16/34	0,17	P2LAX711EENDDN
	G1/4	Pressurised	Self	3,8/-	25/30	0,33	P2LBX712EENDDN
	G3/8	centre	centring	3,8/-	90/90	1,00	P2LCX713EENDDN
	G1/2	position		3,8/-	90/90	1,00	P2LDX714EENDDN

Solenoid operated directional control valves (supplied with 22mm solenoid less coil)

External supply to solenoid valve(s) via ports 12 and 14. Standard temp. range -10°C to +50°C. Max operating pressure 10 bar

Symbol	Size	Actuation	Return	Signal pressure min. (bar) at 6 bar @20°C actua./return	Changeover time (ms) at 6 bar @20°C actua./return	Weight Kg	Order code
5/2 valves, external air, standard temperature							
	G1/8	Electric signal	Electric signal	1,5/1,5	10/10	0,16	P2LAXN11EENDDN
	G1/4			1,5/1,5	22/22	0,31	P2LBXN12EENDDN
	G3/8			1,5/1,5	40/40	0,70	P2LCXN13EENDDN
	G1/2			1,5/1,5	40/40	0,70	P2LDXN14EENDDN
	G1/8	Electric signal	Spring	3,2/-	12/30	0,16	P2LAXN11ESNDDN
	G1/4			3,5/-	15/25	0,30	P2LBXN12ESNDDN
	G3/8			3,5/-	25/65	0,70	P2LCXN13ESNDDN
	G1/2			3,5/-	25/65	0,70	P2LDXN14ESNDDN
	G1/8	Electric signal	Air signal	1,5/1,5	10/6	0,16	P2LAXN11EPNDDN
	G1/4			1,5/1,5	22/10	0,32	P2LBXN12EPNDDN
	G3/8			1,5/1,5	25/40	0,70	P2LCXN13EPNDDN
	G1/2			1,5/1,5	25/40	0,70	P2LDXN14EPNDDN
5/3 valves, external air, standard temperature							
	G1/8	Electric signal	Electric signal	3,8/-	16/34	0,17	P2LAXP11EENDDN
	G1/4	Closed centre	Self	3,8/-	25/30	0,33	P2LBXP12EENDDN
	G3/8	position	centring	3,8/-	90/90	1,00	P2LCXP13EENDDN
	G1/2			3,8/-	90/90	1,00	P2LDXP14EENDDN
	G1/8	Electric signal	Electric signal	3,8/-	16/34	0,17	P2LAXR11EENDDN
	G1/4	Vented centre	Self	3,8/-	25/30	0,33	P2LBXR12EENDDN
	G3/8	position	centring	3,8/-	90/90	1,00	P2LCXR13EENDDN
	G1/2			3,8/-	90/90	1,00	P2LDXR14EENDDN
	G1/8	Electric signal	Electric signal	3,8/-	16/34	0,17	P2LAXQ11EENDDN
	G1/4	Pressurised	Self	3,8/-	25/30	0,33	P2LBXQ12EENDDN
	G3/8	centre	centring	3,8/-	90/90	1,00	P2LCXQ13EENDDN
	G1/2	position		3,8/-	90/90	1,00	P2LDXQ14EENDDN

Order chart - Viking Xtreme Valves - Xtreme operating pressure / temperature

P	2	L	A	X	5	1	1	E	S	H	D	D	B	4	9
----------	----------	----------	----------	----------	----------	----------	----------	----------	----------	----------	----------	----------	----------	----------	----------

Valve family	
P2L	Viking inline valve

Size	
A	1/8
B	1/4
C	3/8
D	1/2

Version	
X	Xtreme duty spool









Port thread	
11	G1/8
12	G1/4
13	G3/8
14	G1/2
91	1/8 NPT
92	1/4 NPT
93	3/8 NPT
94	1/2 NPT

Solenoid pilot type	
H¹	16 bar / -40°C to 60°C

¹ Solenoid operated 'H' version supplied with B type enclosure 16 bar solenoid

Solenoid exhaust	
D	Vented
N	Capture/tapped M5

Overrides	
D	Extended non-locking

Valve type function			
Solenoid operated with internal supply to solenoid			
5		5/2 valve	
6		5/3 valve closed centre position	
7		5/3 valve pressurised centre	
8		5/3 valve vented centre	
Solenoid operated with external pilot supply to solenoids through ports #12 & #14			
N		5/2 valve	
P		5/3 valve closed centre position	
Q		5/3 valve pressurised centre	
R		5/3 valve vented centre	

Pilot main actuator / Return	
E	Solenoid operated valve
S	Spring (return only)
P	Press (return only)

Shaded part numbers are standard

Solenoid enclosure / Lead length	
A	22mm Solenoid pilot & 30mm coil Form A
B	22mm Solenoid pilot & 22mm coil Industrial Form B
N	22mm Solenoid pilot less coil

Voltage ³			
	AC		DC
	60Hz	50Hz	
40	12		
42	24	22	
45			12
47*			12
48*			24
49			24
53	120	110	
57	240	230	
XX	valve less solenoid/coil		

³ Mobile voltage see page 32 operating parameters





³ Shaded part numbers are available from stock
Unshaded part numbers are available on request but will be subject to minimum order quantities
Otherwise order coil and valve separately.

J

Solenoid operated directional control valves - Xtreme duty -40°C to +60°C**P2LAX/P2LBX - 16 bar, P2LCX/P2LDX - 12 bar**

Complete with 22mm solenoid and 24V DC coil.

Internal supply to solenoid valve(s) via port 1. Connector/cable plugs to be ordered separately.

Symbol	Size	Actuation	Return	Signal pressure min. (bar) at 6 bar @20°C actua./return	Changeover time (ms) at 6 bar @20°C actua./return	Weight Kg	Order code
5/2 valves, internal air, low temperature							
	G1/8	Electric signal	Electric signal	1,5/1,5	15/15	0,27	P2LAX511EEHDB49
	G1/4		Low temp.	1,5/1,5	25/25	0,42	P2LBX512EEHDB49
	G3/8			1,5/1,5	45/45	0,48	P2LCX513EEHDB49
	G1/2						P2LDX514EEHDB49
	G1/8	Electric signal	Spring	3,2/-	15/30	0,22	P2LAX511ESHDB49
	G1/4		Low temp.	3,5/-	20/25	0,38	P2LBX512ESHDB49
	G3/8			3,5/-	30/65	0,46	P2LCX513ESHDB49
	G1/2			3,5/-	30/65	0,46	P2LDX514ESHDB49
5/3 valves, internal air, low temperature							
	G1/8	Electric signal	Electric signal	3,8/-	16/34	0,28	P2LAX611EEHDB49
	G1/4	Closed centre	Self	3,8/-	25/30	0,45	P2LBX612EEHDB49
	G3/8	position	centring	3,8/-	90/90	0,55	P2LCX613EEHDB49
	G1/2		Low temp.	3,8/-	90/90	0,55	P2LDX614EEHDB49
	G1/8	Electric signal	Electric signal	3,8/-	16/34	0,28	P2LAX811EEHDB49
	G1/4	Vented centre	Self	3,8/-	25/30	0,45	P2LBX812EEHDB49
	G3/8	position	centring	3,8/-	90/90	0,55	P2LCX813EEHDB49
	G1/2		Low temp.	3,8/-	90/90	0,55	P2LDX814EEHDB49
	G1/8	Electric signal	Electric signal	3,8/-	16/34	0,28	P2LAX711EEHDB49
	G1/4	Pressurised	Self	3,8/-	25/30	0,45	P2LBX712EEHDB49
	G3/8	centre	centring	3,8/-	90/90	0,55	P2LCX713EEHDB49
	G1/2	position	Low temp.	3,8/-	90/90	0,55	P2LDX714EEHDB49

Solenoid operated directional control valves - Xtreme duty -40°C to +60°C

P2LAX/P2LBX - 16 bar, P2LCX/P2LDX - 12 bar

Valves fitted with 22mm solenoid operator(s) less coil(s). Order coils and plug/connectors separately

Internal supply to solenoid valve(s) via port 1.

Symbol	Size	Actuation	Return	Signal pressure min. (bar) at 6 bar @20°C actua./return	Changeover time (ms) at 6 bar @20°C actua./return	Weight Kg	Order code
5/2 valves, internal air, low temperature							
	G1/8	Electric signal	Electric signal	1,5/1,5	10/10	0,16	P2LAX511EEHDDN
	G1/4			1,5/1,5	22/22	0,31	P2LBX512EEHDDN
	G3/8			1,5/1,5	40/40	0,41	P2LCX513EEHDDN
	G1/2			1,5/1,5	40/40	0,41	P2LDX514EEHDDN
	G1/8	Electric signal	Spring	3,2/-	12/30	0,16	P2LAX511ESHDDN
	G1/4			3,5/-	15/25	0,31	P2LBX512ESHDDN
	G3/8			3,5/-	25/65	0,40	P2LCX513ESHDDN
	G1/2			3,5/-	25/65	0,40	P2LDX514ESHDDN
5/3 valves, internal air, low temperature							
	G1/8	Electric signal	Electric signal	3,8/-	16/34	0,17	P2LAX611EEHDDN
	G1/4	Closed centre	Self	3,8/-	25/30	0,33	P2LBX612EEHDDN
	G3/8	position	centring	3,8/-	90/90	0,42	P2LCX613EEHDDN
	G1/2			3,8/-	90/90	0,42	P2LDX614EEHDDN
	G1/8	Electric signal	Electric signal	3,8/-	16/34	0,17	P2LAX811EEHDDN
	G1/4	Vented centre	Self	3,8/-	25/30	0,33	P2LBX812EEHDDN
	G3/8	position	centring	3,8/-	90/90	0,42	P2LCX813EEHDDN
	G1/2			3,8/-	90/90	0,42	P2LDX814EEHDDN
	G1/8	Electric signal	Electric signal	3,8/-	16/34	0,17	P2LAX711EEHDDN
	G1/4	Pressurised	Self	3,8/-	25/30	0,33	P2LBX712EEHDDN
	G3/8	centre	centring	3,8/-	90/90	0,42	P2LCX713EEHDDN
	G1/2	position		3,8/-	90/90	0,42	P2LDX714EEHDDN

Solenoid operated directional control valves - Xtreme duty -40°C to + 60°C

P2LAX/P2LBX - 16 bar, P2LCX/P2LDX - 12 bar

Valves fitted with 22mm solenoid operator(s) less coil(s). Order coils and plug/connectors separately

External supply to solenoid valve(s) via ports 12 & 14.

Symbol	Size	Actuation	Return	Signal pressure min. (bar) at 6 bar @20°C actua./return	Changeover time (ms) at 6 bar @20°C actua./return	Weight Kg	Order code
5/2 valves, external air to pilot operators							
	G1/8	Electric signal	Electric signal	1,5/1,5	10/10	0,27	P2LAXN11EEHDDN
	G1/4			1,5/1,5	22/22	0,42	P2LBXN12EEHDDN
	G3/8			1,5/1,5	40/40	0,81	P2LCXN13EEHDDN
	G1/2			1,5/1,5	40/40	0,81	P2LDXN14EEHDDN
	G1/8	Electric signal	Spring	3,2/-	12/30	0,22	P2LAXN11ESHDDN
	G1/4			3,5/-	15/25	0,38	P2LBXN12ESHDDN
	G3/8			3,5/-	25/65	0,76	P2LCXN13ESHDDN
	G1/2			3,5/-	25/65	0,76	P2LDXN14ESHDDN
5/3 valves, external air to pilot operators							
	G1/8	Electric signal	Electric signal	3,8/-	16/34	0,28	P2LAXP11EEHDDN
	G1/4	Closed centre	Self	3,8/-	25/30	0,44	P2LBXP12EEHDDN
	G3/8	position	centring	3,8/-	90/90	1,11	P2LCXP13EEHDDN
	G1/2			3,8/-	90/90	1,11	P2LDXP14EEHDDN
	G1/8	Electric signal	Electric signal	3,8/-	16/34	0,28	P2LAXR11EEHDDN
	G1/4	Vented centre	Self	3,8/-	25/30	0,44	P2LBXR12EEHDDN
	G3/8	position	centring	3,8/-	90/90	1,11	P2LCXR13EEHDDN
	G1/2			3,8/-	90/90	1,11	P2LDXR14EEHDDN
	G1/8	Electric signal	Electric signal	3,8/-	16/34	0,28	P2LAXQ11EEHDDN
	G1/4	Pressurised	Self	3,8/-	25/30	0,44	P2LBXQ12EEHDDN
	G3/8	centre	centring	3,8/-	90/90	1,11	P2LCXQ13EEHDDN
	G1/2	position		3,8/-	90/90	1,11	P2LDXQ14EEHDDN

Dimensions

P2LAX... all
5/2 and 5/3 valves

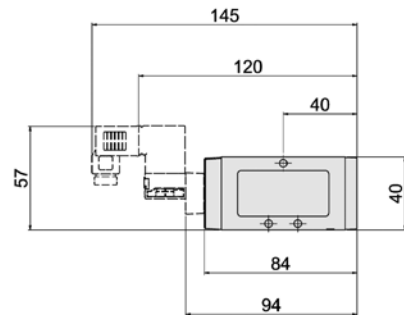
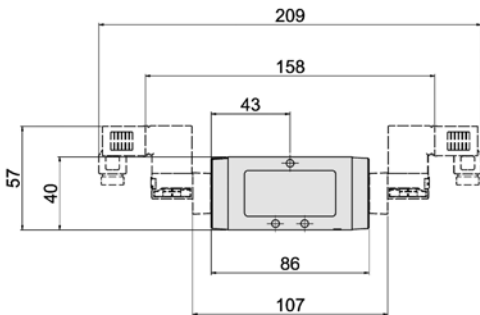
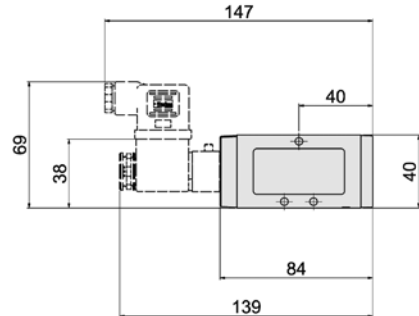
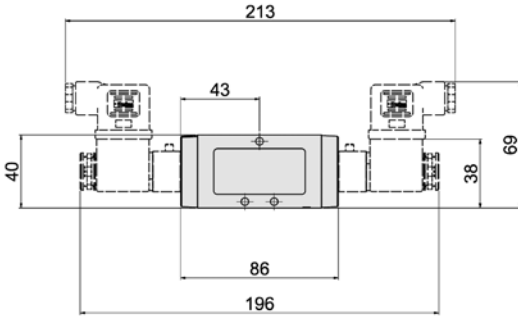
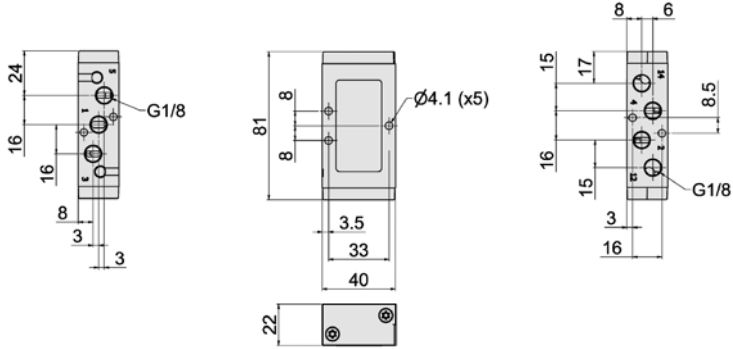

Solenoid valves

Solenoid valves and cable plugs must be ordered separately.
One pilot valve is required for each E in the valve order code.

Dimensions

P2LAX - Lever operated directional control valves

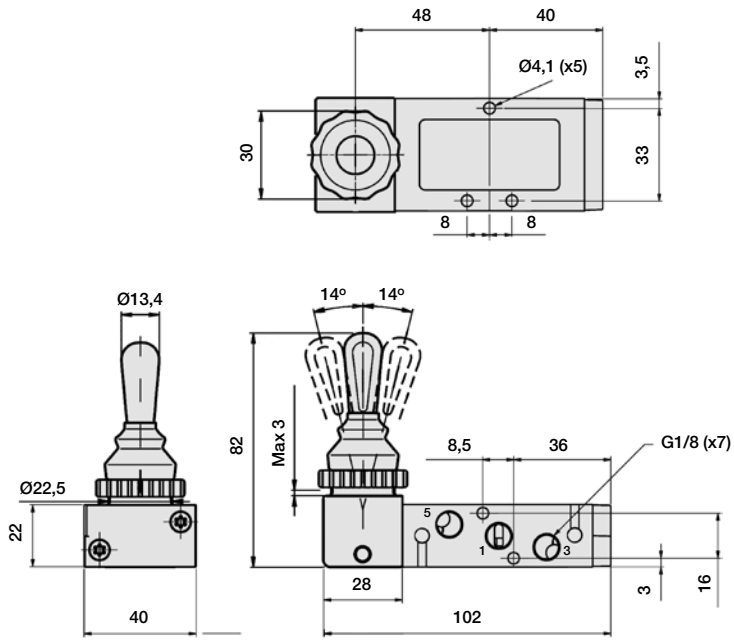

J

Dimensions

P2LBX - 5/2 Lever operated directional control valves

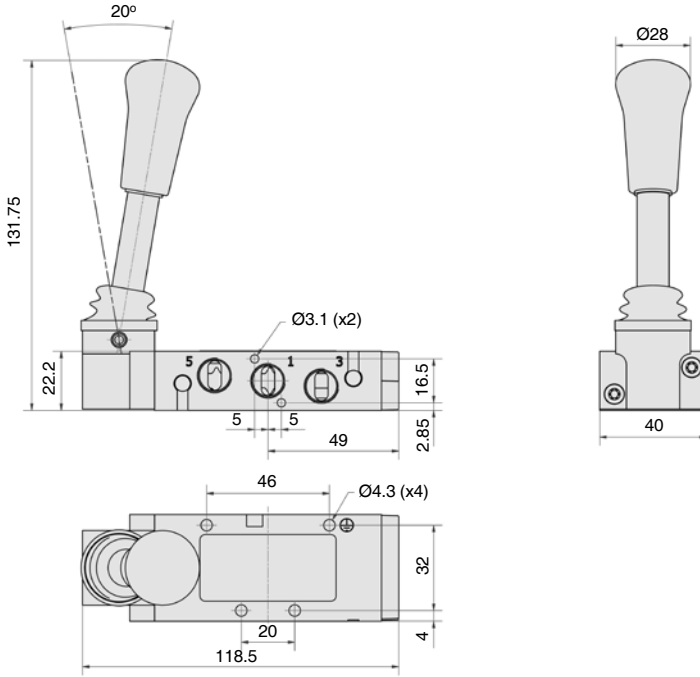

P2LBX - 5/3 Lever operated directional control valves

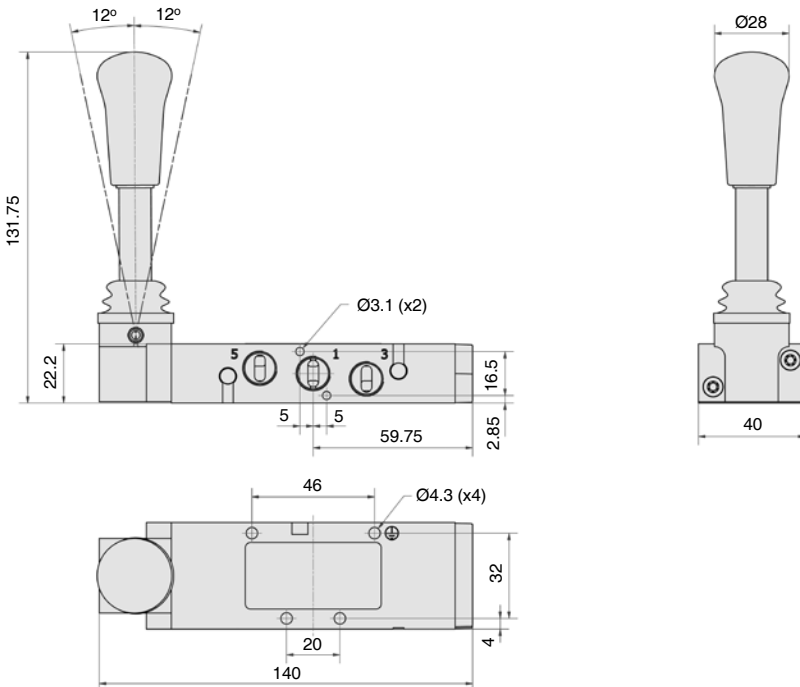

Dimensions

P2LCX - 5/2 Lever operated directional control valves

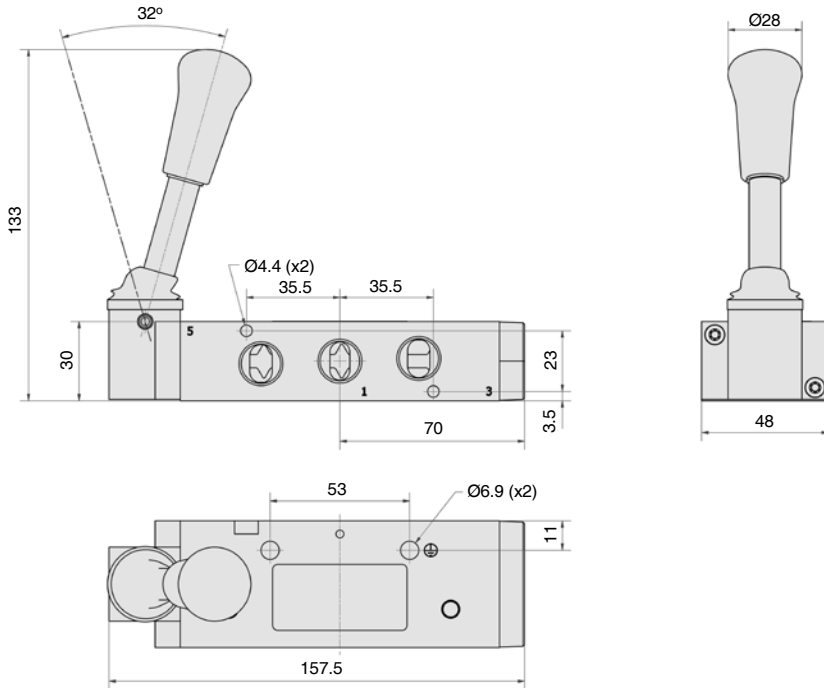

P2LCX - 5/3 Lever operated directional control valves

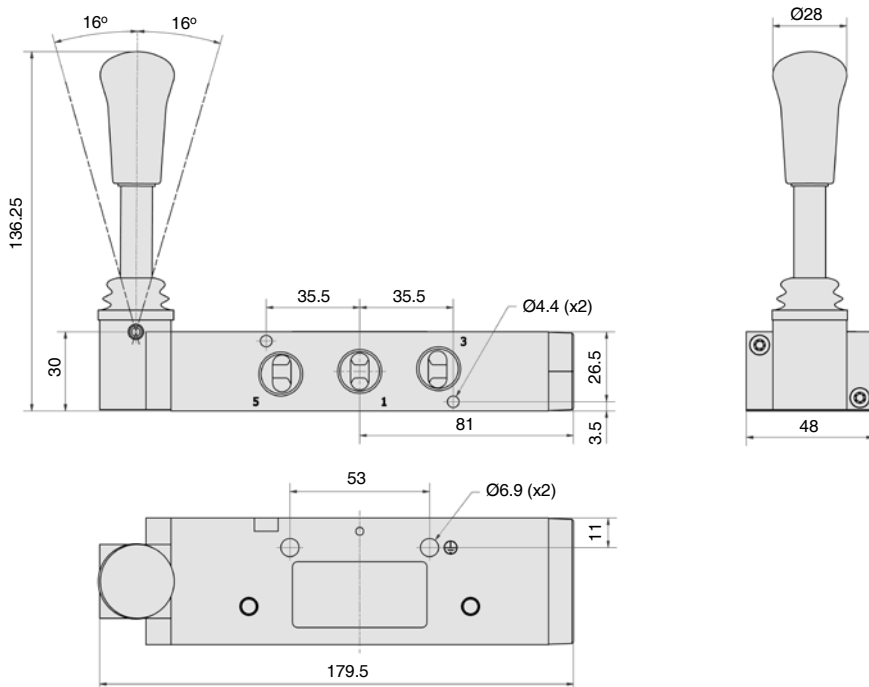

J

Dimensions

P2LDX - 5/2 Lever operated directional control valves

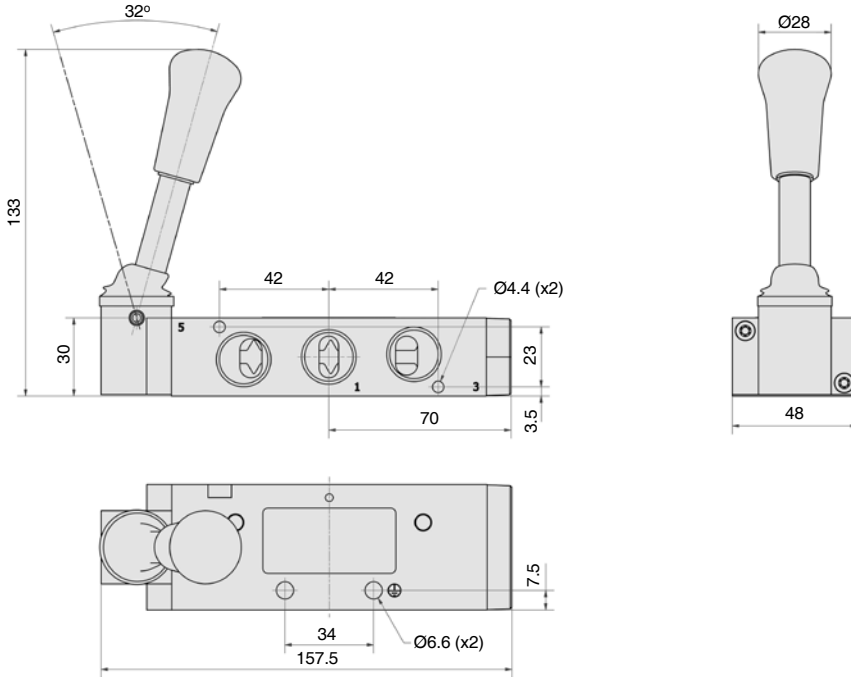

P2LDX - 5/3 Lever operated directional control valves

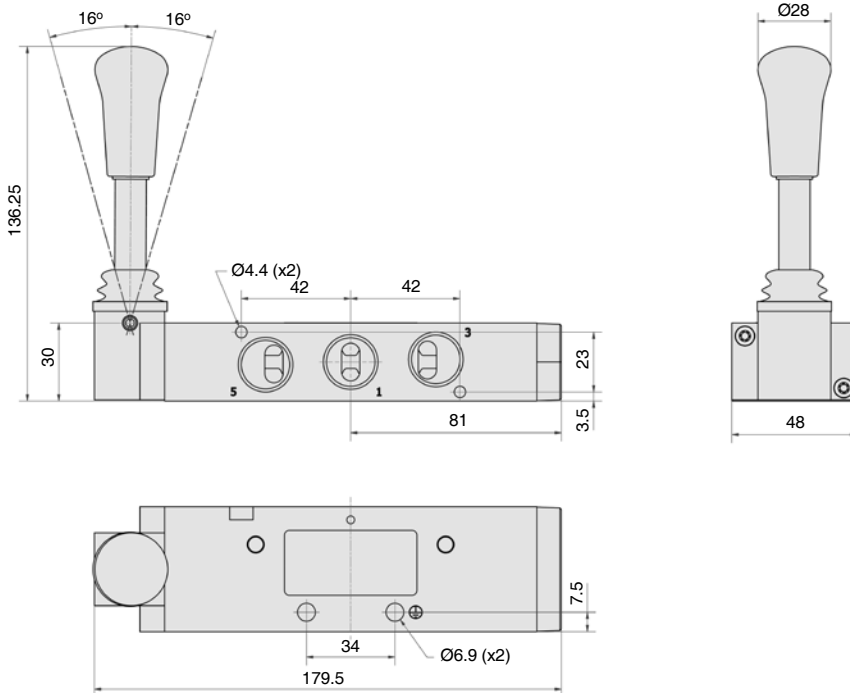

Dimensions

P2LBX... all
 5/2 and 5/3 valves

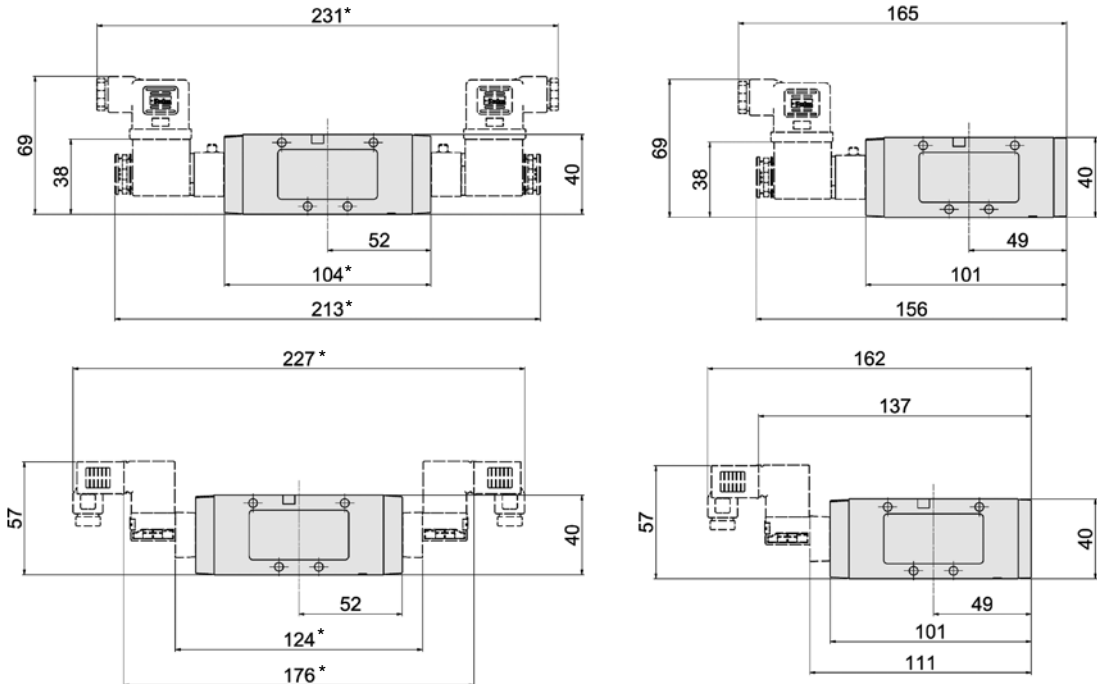
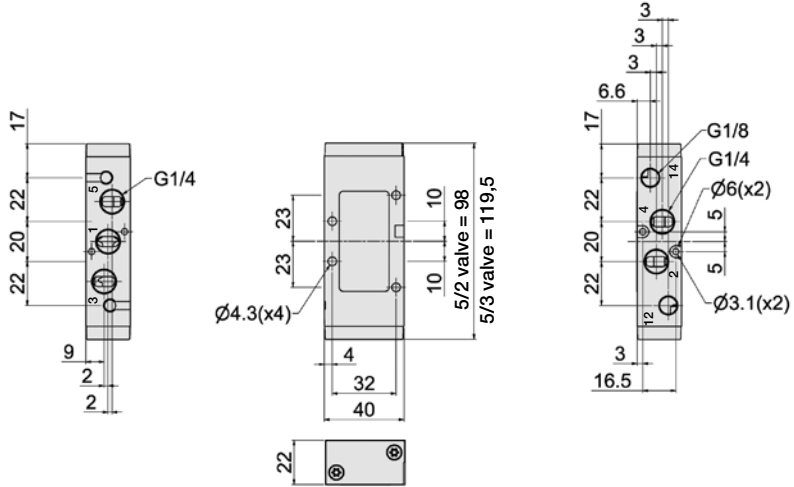

* Note: 5/3 valves - add 21.5mm

Solenoid valves
 Solenoid valves and cable plugs must be ordered separately.
 One pilot valve is required for each E in the valve order code.

J

Dimensions

P2LCX... all
5/2 and 5/3 valves

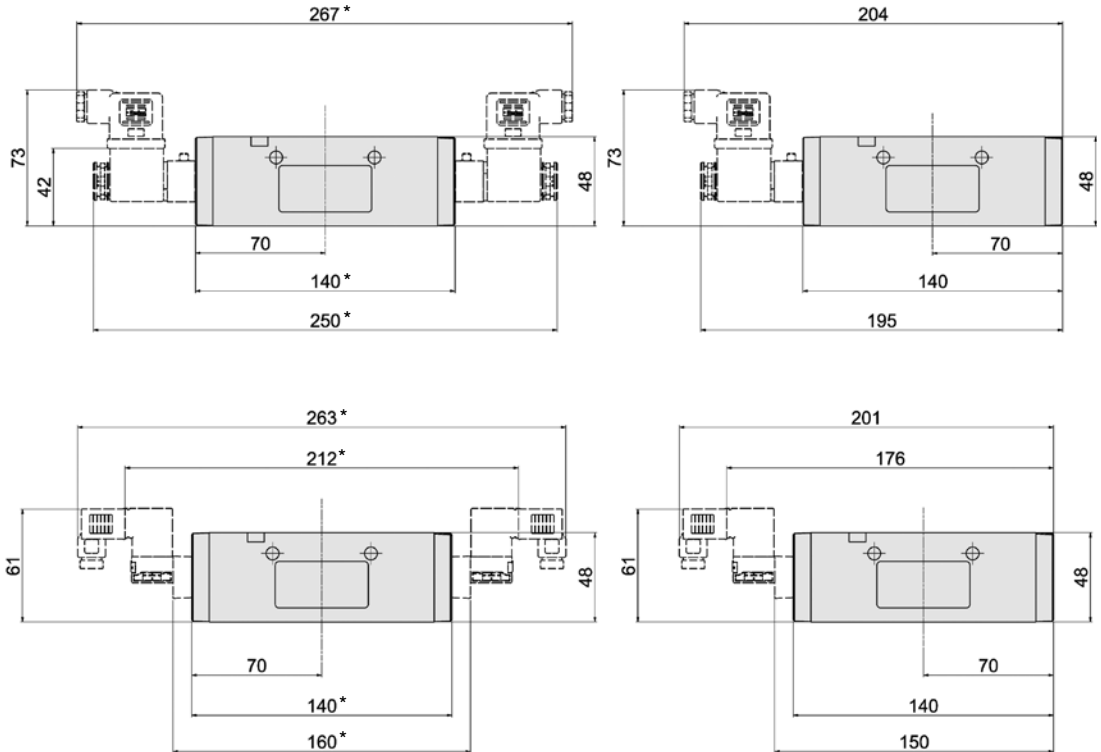
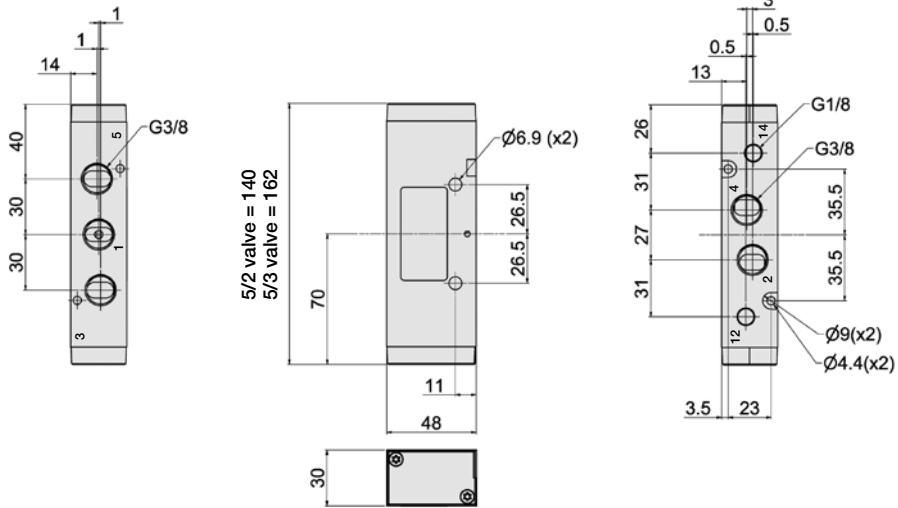

* Note: 5/3 valves - add 22.0mm

Solenoid valves
Solenoid valves and cable plugs must be ordered separately.
One pilot valve is required for each E in the valve order code.

Dimensions

P2LDX... all
 5/2 and 5/3 valves

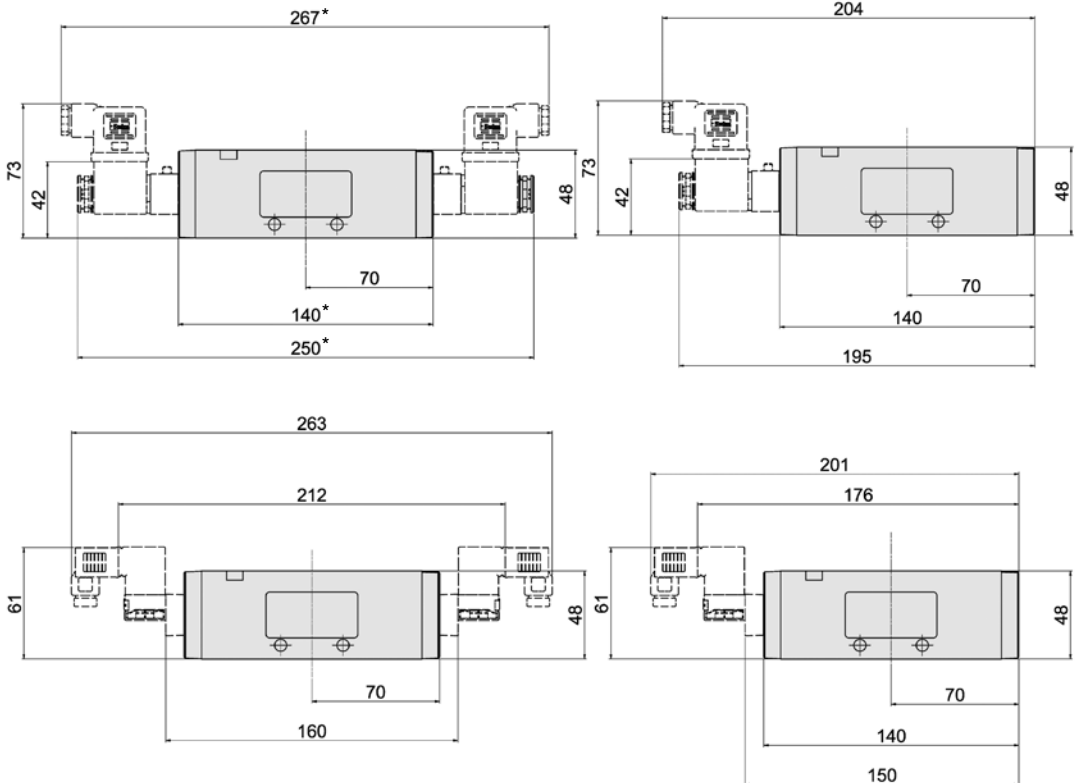
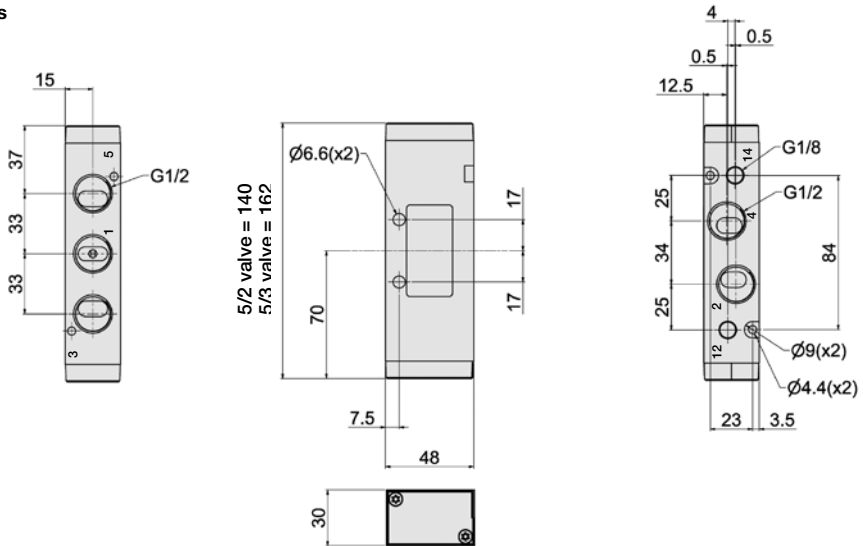

* Note: 5/3 valves - add 22.0mm

Solenoid valves
 Solenoid valves and cable plugs must be ordered separately.
 One pilot valve is required for each E in the valve order code.

J

P2LAX, flexible manifold assembly

A practical system solution with the aid of connection pieces. The manifolds can easily be assembled from the top to form a compact and stable block. The block can then be installed in cabinets or directly on the machine frame as shown in the example in the bottom of this page.

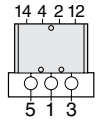

Valve:
with cylinder ports 2 and 4 and signal ports 12 and 14 facing upwards, enabling easily access to connection ports. All ports are G1/8 threaded to simplify choice of connectors.

Manifold:
with common channels for ports 1, 3 and 5.



Connection block S:
straight connection block with a side ports for common air supply and exhaust.

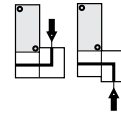

Connection block L:
angled connection block for top or bottom ported.



End cover

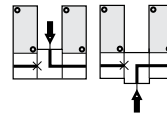
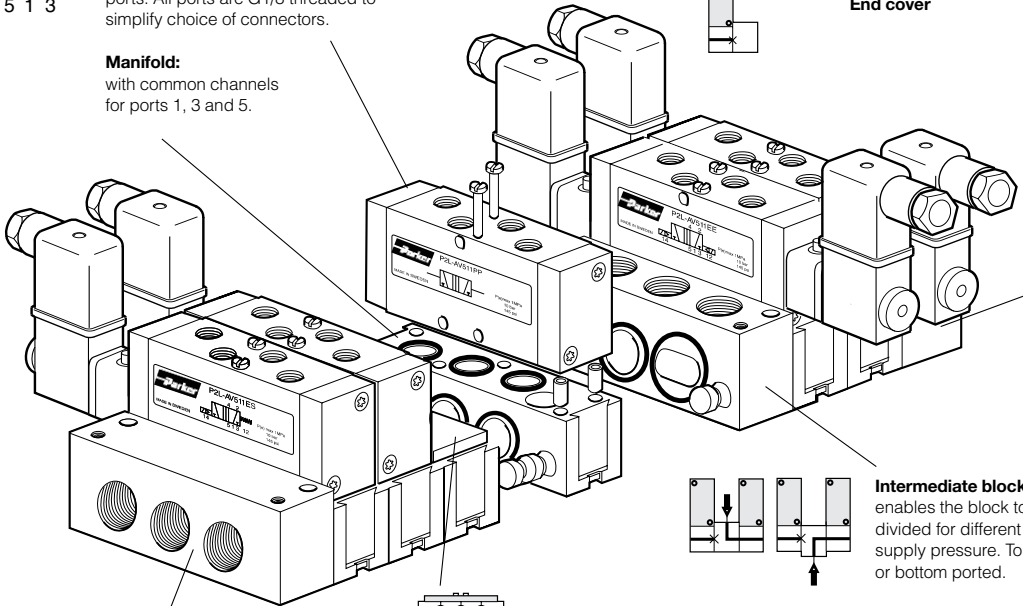

Intermediate block L:
enables the block to be divided for different supply pressure. Top or bottom ported.

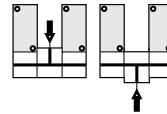

Intermediate block T:
permits the connection of air between two manifolds. Top or bottom ports.



Connection block S:
straight connection block with a side ports for common air supply and exhaust.

Blanking plate:
To incorporate spare positions.

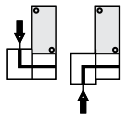



Connection block L:
angled connection block for top or bottom ported.

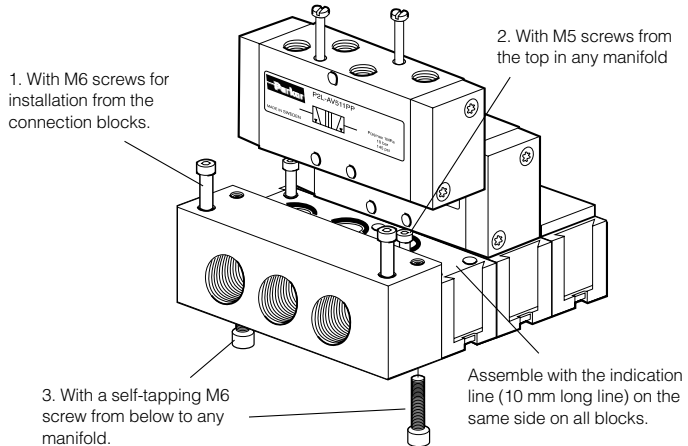

End cover

Various mounting options

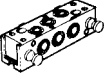
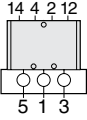
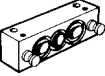
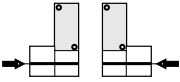
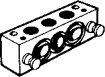
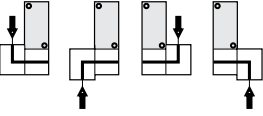
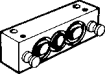
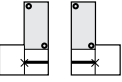
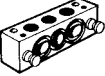
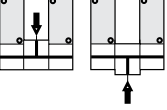
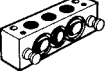
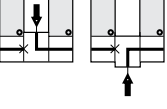

Accessories P2LA	Connection alternatives	Type	Weight kg	Order code
		Multiple manifold including seals, mounting screws, and guiding pins.	0,11	9121658060
		Connection block S including seals, mounting screws, and guiding pins. G1/4	0,15	9121658064
		Connection block L including seals, mounting screws, and guiding pins. G1/4	0,15	9121658061
		End cover including seals, mounting screws, and guiding pins.	0,16	9121658066
		Intermediate block T including seals, mounting screws, and guiding pins. G1/4	0,17	9121658062
		Intermediate block L including seals, mounting screws, and guiding pins. G1/4	0,17	9121658065
		Blanking plate including seals, mounting screws.	0,05	9121658063

J

Dimensions

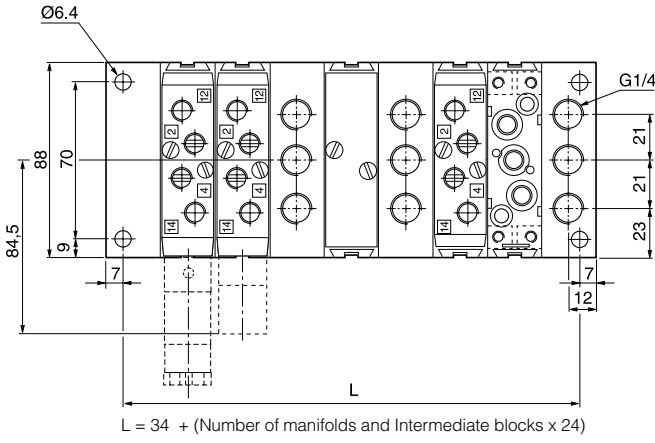

Connection block L and intermediate blocks L and T can be turned so that connection can be made from above or below.

Multiple manifolds must be fitted with the top indication line (a 10 mm long line) facing the same side on all manifolds.

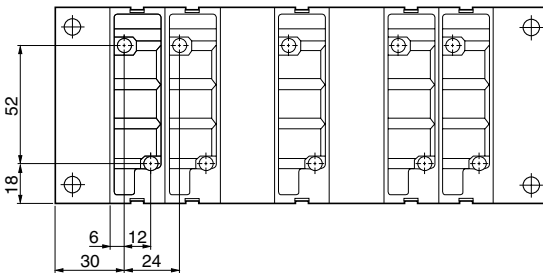
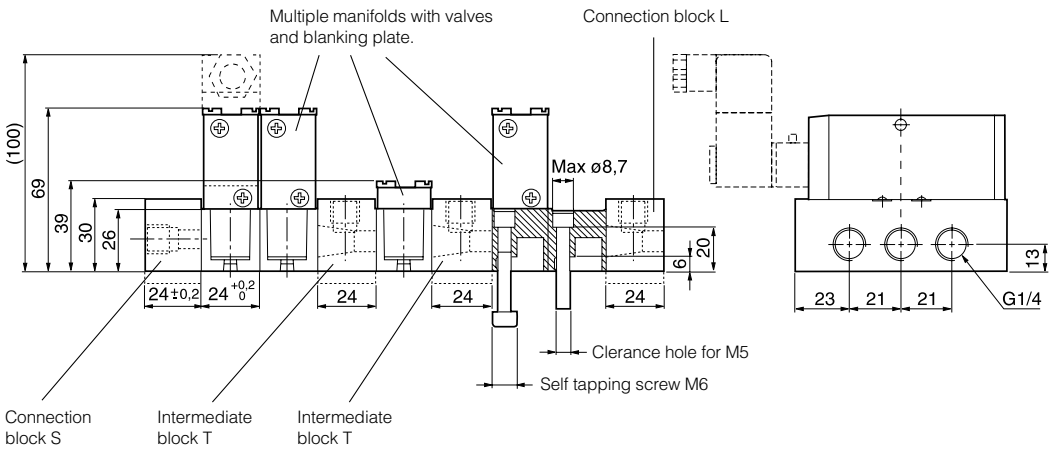

Accessories P2LA	Type	Weight kg	Order code
	Manifold bar, P2LA including seals, mounting screws. G3/8 For 4 valves For 6 valves For 8 valves For 10 valves For 12 valves For 14 valves	0,48 0,63 0,80 0,98 1,10 1,23	9121658075 9121658076 9121658077 9121658078 9121658079 9121658099
	Blanking plate, P2LA for Manifold bar	0,05	9121658063
	Pressure bar, P2LA for common air supply incl. O-rings and mounting screws. G1/4 For 2 valves For 4 valves For 6 valves For 8 valves	0,13 0,20 0,26 0,33	9121658070 9121658071 9121658072 9121658073
	Blanking plate, P2LA for Pressure bar	0,05	9121658074
	Assembly screws, P2LA in stainless steel for valve	0,02	9121658043
	Assembly screws, P2LA in stainless steel for blanking plate	0,01	9121658044
	O-ring kit, P2LA O-rings between valve and manifold bar/Pressure bar	0,01	9121658046

Dimensions

Manifold bar, P2LA

No. of valves	L mm
4	126
6	174
8	222
10	270
12	318
14	366

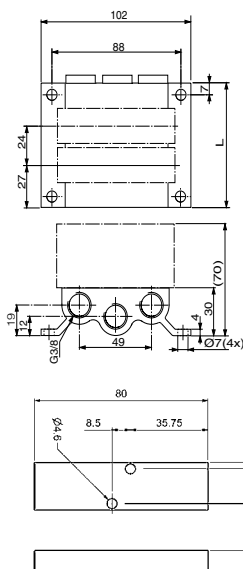

Blanking plate for manifold bar, P2LA

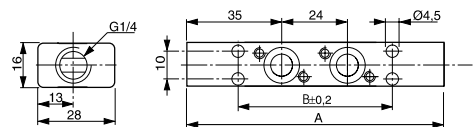

Pressure bar, P2LA

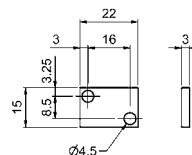

Blanking plate for pressure bar, P2LA

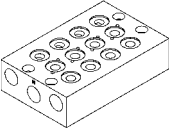
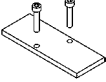
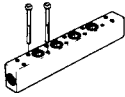

No. of valves	A mm	B mm
2	94	56
4	142	104
6	190	152
8	238	200

Accessories P2LB	Type	Weight kg	Order code
	Manifold bar, P2LB, (not for P2LB with external air supply to solenoid valves) incl. fasteners and O-ring. G3/8 For 2 valves For 4 valves For 6 valves For 8 valves For 10 valves	0,69 1,13 1,56 2,00 2,45	9121594805X 9121594806X 9121594807X 9121594808X 9121594812X
	Blanking plate, P2LBX for Manifold bar	0,10	9121594809X
	Pressure bar, P2LBX for common air supply incl. O-rings and mounting screws. G3/8 For 2 valves For 4 valves For 6 valves For 8 valves For 10 valves	0,38 0,53 0,68 0,83 0,99	9127113301X 9127113302X 9127113303X 9127113304X 9127113305X
	Blanking plate P2LBX for Pressure bar. G1/4	0,02	9127113306X

Dimensions

Manifold bar, P2LB

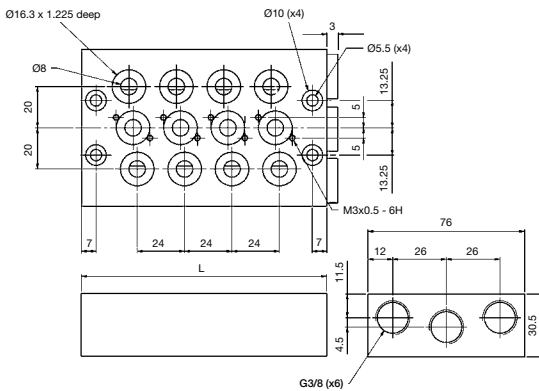

No. of valves	L mm
2	74
4	122
6	170
8	218
10	266

Blanking plate for manifold bar, P2LB

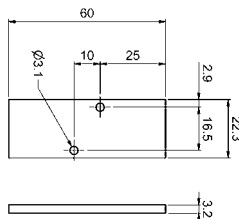

Pressure bar, P2LB

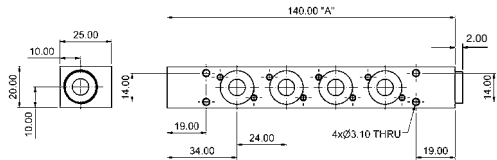

Blanking plate for pressure bar, P2LB

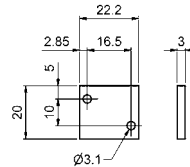

No. of valves	A mm
2	92
4	140
6	188
8	236
10	284

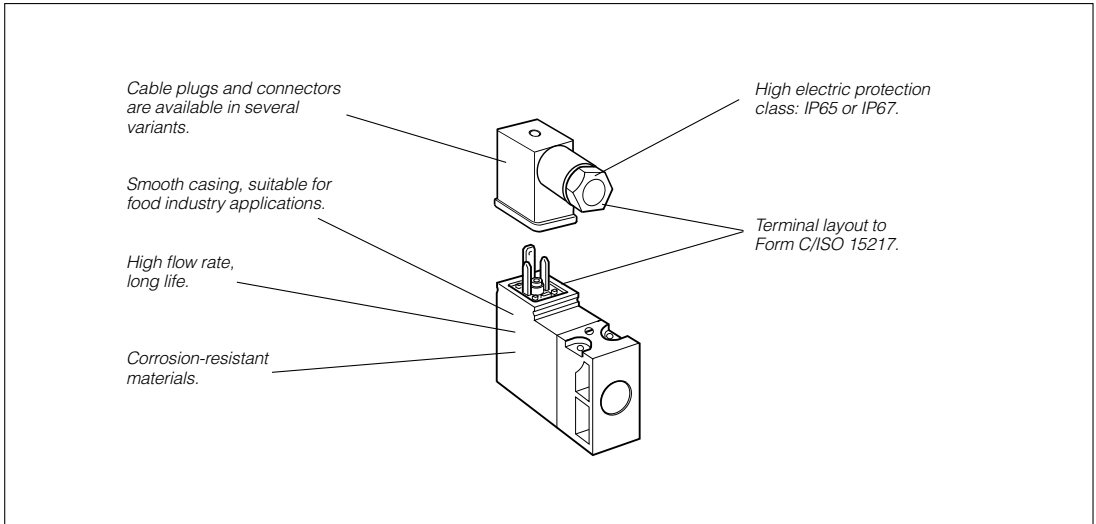

The P2E-•V solenoid operator range

The P2E-•V range of operators are normally closed (NC) 3/2 solenoid valves, with exceedingly compact dimensions in relation to their capacity.

International standard

The port connection pattern complies with a new French CNOMO standard (in process of drafting), with cable plug connections in accordance with Form C/ISO15217.

Compact design

Overall dimensions of the P2E-•V operators are substantially less than those of earlier generations of solenoid operators.

High flow capacity

High flow capacity relative to the electrical operating power as a result of optimised internal flow paths.

Corrosion-resistant design

The valve is made of thermoplastic material and stainless steel, with Viton™ and nitrile rubber seals for excellent corrosion resistance.

Clean lines suitable for food industry applications, P2E-QV

The valve has been designed in conjunction with several machine manufacturers and organisations in the food processing industry, with corrosion-resistant materials and smooth lines being important starting points. The valve and its accessories have been designed so that there are no gaps or crevices in which dirt could collect.

High reliability

Few moving parts result in high reliability, rapid changeover and very long life.

Low power demand

The solenoids have a power demand of 1.2 W at 24 V DC and 1.6 VA at 24 V AC, 115 V AC and 230 V AC.

High protection class

The protection class is IP 67 when connected using the cable plug with a moulded cable. When using the standard cable plug for fitting by the user, the protection class is IP65, the bare valve, with Fast-on connectors, has an encapsulation class of IP 20.

Insensitive to dirty air

The use of generously sized flow paths (1.0 mm diameter) means that the valve can be used in normal industrial environments without problems of blocking.

Manual override as option

The operators can be supplied with or without manual override. The manual override device is available as a screwdriver groove or with a control arm, and is either spring return (blue) or lockable (yellow).

J

Order key, solenoid operators (15mm)

P	2	E	-	Q	V	3	2	C	3
----------	----------	----------	----------	----------	----------	----------	----------	----------	----------

Valve family	
P2E	Solenoid operator

Subfamily	
Solenoid operator, 15 mm wide Electric connection acc. to ISO 15217 Form C EI/supply connection on opposite side	
K	Standard version
M	Mobile version
Q	Food industry version

Type of current	
1	AC 50 Hz
2	DC
4	AC 50/60 Hz
5	Mobile and wide band only

Voltage	
B	12 V
C	24 V
D	48 V
F	115 V*
J	230 V*
W	37,5 V**
T	72 V**
Y	78 V**
V	96 V**
E	110 V**

Overriders	
0	Without
1	Non locking (blue)
2	Locking (yellow)
3	Extended non locking (blue)
4	Extended locking (yellow)

Valvetype/Function	
3	 3/2 valve, normally closed (NC)

* For standard and food type only
** For mobile "M" version only

Technical data

	NC, Standard	NC, Food ¹⁾	NC, Mobile ²⁾
Working pressure	0 to 10 bar	0 to 10 bar	0 to 10 bar
Working temperature	-15 °C to +60 °C	-15 °C to +60 °C	-40 °C to +70 °C
Orifice	1,0 mm	1,0 mm	1,0 mm
Flow Qmax	33 Nl/min	33 Nl/min	22 Nl/min
Power, hold	DC 1,2 W / AC 1,6 VA	DC 1,2 W / AC 1,6 VA	DC 1 W
Power, surge	DC 1,2 W / AC 3,5 VA	DC 1,2 W / AC 3,5 VA	DC 1 W
Connection time	100%	100%	100%
Voltage tolerance	+10%/–15%	+10%/–15%	+25%/–30%
Electric connection:	Form C/ISO15217		
Port pattern:	To future CNOMO standard		
Protection:	IP 65 - IP 67, depending on type of cable plug		
Approval:	Some valves are UL-approved and marked with the following symbol ☉		
Working media:	All neutral media, such as compressed air, water, hydraulic oil and many gases.		
1) Design:	Completely smooth exterior, suitable for food industry.		
2) Mobile standard	According to European standard EN 50 155.		

Transients

Interrupting the current through the solenoid coil produces momentary voltage peaks which, under unfavourable conditions, can amount to several hundred times the rated operating voltage. Normally, these transients do not cause problems, but to achieve the maximum life of relays in the circuit (and particularly of transistors, thyristors and integrated circuits) it is desirable to provide protection by means of voltage-dependent resistors (varistors). All cable plugs with a yellow LED also incorporate such protection.

Service life

With compressed air at 6 bar, 20 °C and complying with the requirements for compressed air quality as set out in ISO8573-1 norm (class 4 for dry and class 5 for filtered air), the valves should have a life of at least 50 million cycles.

Materials

Operator

Body, coil casing	Thermoplastic
Internal metal parts	Steel
Screws	Stainless steel
Bottom plug	Thermoplastic
Sealing materials	FPM (Viton™) and nitrile rubber

Cable head

Sheath	Thermoplastic
Retaining screw	Stainless steel, zinc-plated steel

15mm Solenoid Operators

Electrical connection EN175301-803 C/ISO15217 (Ex DIN 43650C)

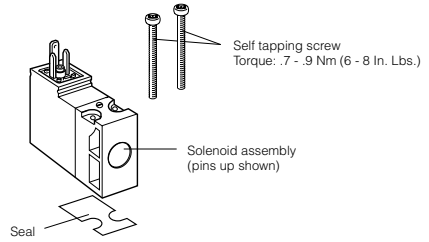

Solenoids 15 mm NC, standard

(Note! Mounting screws included in basic valve)

	Voltage	Weight Kg	Order code Without manual override	Weight Kg	Order code Override, blue, non locking flush	Weight Kg	Order code Override, yellow, locking flush
	12 VDC	0,038	P2E-KV32B0 Ⓢ	0,038	P2E-KV32B1 Ⓢ	0,038	P2E-KV32B2 Ⓢ
	24 VDC	0,038	P2E-KV32C0 Ⓢ	0,038	P2E-KV32C1 Ⓢ	0,038	P2E-KV32C2 Ⓢ
	48 VDC	0,038	P2E-KV32D0 Ⓢ	0,038	P2E-KV32D1 Ⓢ	0,038	P2E-KV32D2 Ⓢ
	24 VAC 50Hz	0,038	P2E-KV31C0 Ⓢ	0,038	P2E-KV31C1 Ⓢ	0,038	P2E-KV31C2 Ⓢ
	48 VAC 50/60Hz	0,038	P2E-KV34D0 Ⓢ	0,038	P2E-KV34D1 Ⓢ	0,038	P2E-KV34D2 Ⓢ
	115 VAC 50Hz/ 120 VAC 60Hz	0,038	P2E-KV31F0 Ⓢ	0,038	P2E-KV31F1 Ⓢ	0,038	P2E-KV31F2 Ⓢ
	230 VAC 50Hz/ 240 VAC 60Hz	0,038	P2E-KV31J0 Ⓢ	0,038	P2E-KV31J1 Ⓢ	0,038	P2E-KV31J2 Ⓢ
	Voltage		Weight Kg	Order code Override extended, blue, non locking flush	Weight Kg	Order code Override extended, yellow, locking flush	
	24 VDC		0,038	P2E-KV32C3 Ⓢ	0,038	P2E-KV32C4 Ⓢ	
	24 VAC 50Hz		0,038	P2E-KV31C3 Ⓢ	0,038	P2E-KV31C4 Ⓢ	

Solenoids 15 mm NC, mobile

(Note! Mounting screws included in basic valve)

	Voltage	Weight Kg	Order code Without manual override	Weight Kg	Order code Override, blue, non locking flush
	12 VDC	0,038	P2E-MV35B0	0,038	P2E-MV35B1
	24 VDC	0,038	P2E-MV35C0	0,038	P2E-MV35C1
	37,5 VDC	0,038	P2E-MV35W0	0,038	P2E-MV35W1
	48 VDC	0,038	P2E-MV35D0	0,038	P2E-MV35D1
	72 VDC	0,038	P2E-MV35T0	0,038	P2E-MV35T1
	78 VDC	0,038	P2E-MV35Y0	0,038	P2E-MV35Y1
	96 VDC	0,038	P2E-MV35V0	0,038	P2E-MV35V1
	110 VDC	0,038	P2E-MV35E0	0,038	P2E-MV35E1

Solenoids 15 mm NC, food industry version

(Note! Mounting screws included in basic valve)

	Voltage	Weight Kg	Order code Without manual override	Weight Kg	Order code Override, blue, non locking flush	Weight Kg	Order code Override, yellow, locking flush
	24 VDC	0,038	P2E-QV32C0 Ⓢ	0,038	P2E-QV32C1 Ⓢ	0,038	P2E-QV32C2 Ⓢ
	48 VDC	0,038	P2E-QV32D0 Ⓢ	0,038	P2E-QV32D1 Ⓢ	0,038	P2E-QV32D2 Ⓢ
	24 VAC 50Hz	0,038	P2E-QV31C0 Ⓢ	0,038	P2E-QV31C1 Ⓢ	0,038	P2E-QV31C2 Ⓢ
	48 VAC 50/60Hz	0,038	P2E-QV34D0 Ⓢ	0,038	P2E-QV34D1 Ⓢ	0,038	P2E-QV34D2 Ⓢ
	115 V 50Hz/ 120 V 60Hz	0,038	P2E-QV31F0 Ⓢ	0,038	P2E-QV31F1 Ⓢ	0,038	P2E-QV31F2 Ⓢ
	230 VAC 50Hz/ 240 VAC 60Hz	0,038	P2E-QV31J0 Ⓢ	0,038	P2E-QV31J1 Ⓢ	0,038	P2E-QV31J2 Ⓢ
		Voltage		Weight Kg	Order code Override extended, blue, non locking flush	Weight Kg	Order code Override extended, yellow, locking flush
	24 VDC		0,038	P2E-QV32C3 Ⓢ	0,038	P2E-QV32C4 Ⓢ	
	24 VAC 50Hz		0,038	P2E-QV31C3 Ⓢ	0,038	P2E-QV31C4 Ⓢ	
	115 VAC 50 Hz		0,038	P2E-QV31F3 Ⓢ	0,038	P2E-QV31F4 Ⓢ	
	230 VAC 50 Hz		0,038	P2E-QV31J3 Ⓢ	0,038	P2E-QV31J4 Ⓢ	

In accordance with the EU Machine Directive, EN 983, solenoid valves with manual override should have spring-return operating arms for safety.

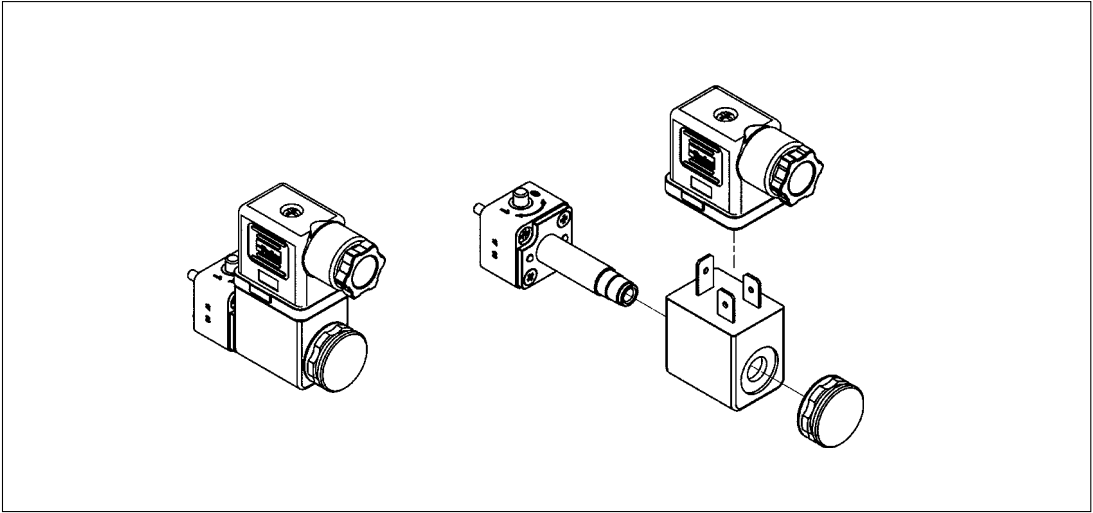

22mm Solenoid pilot options

The P2F P13*4* (NC) 3/2 solenoid pilot operators are designed for piloting pneumatic control valves with compressed air or other inert gases.

The P2F P operator is available for Normal operating pressures up to 10 bar having an outlet orifice 1.3mm and exhaust orifice 1.5 mm. An alternative operator is also available having an outlet orifice of 0.8mm and exhaust orifice of 1.0mm for Xtreme maximum operating pressure of 16 bar and wide band voltage tolerances required for mobile applications.

Corrosion resistant design

The pilot operator body is manufactured in thermoplastic PA 6 material and the core tube brass/stainless steel. The plunger/core is made from stainless steel and the valve seats from FKM.

Solenoid Pilot Exhaust

These operators all exhaust out of the top of the core tube which is tapped M5. The standard solenoid nut fitted to the core tube is the Diffuser nut which allows the exhaust to escape to atmosphere. This nut also minimises ingress of dirt into the valve through this port. The alternative plastic knurled nut can be specified (refer to part number system) if the exhaust air needs to be captured and piped away using the M5 tapped port.

Coils

Coils are wound with enameled copper wire, having temperature index 180°C with class F insulation (155°C) and are encapsulated in Thermoplastic resin. When fitted with suitable connector and correct gasket they give protection to IP65.

Mobile Applications

Viking Xtreme valves are tested to +5g shock and vibration. Solenoid operated valves are designed to operate with wide voltage tolerance bands within the ambient temperature ranges stated in the technical section.

Manual Override options

The pilot operators can be supplied with or without manual override. The standard manual override is the monostable (spring return) extended brass override. Alternatively the bistable (locking) override can be specified as an alternative for the Normal duty 10bar option.

Spares

Solenoid operators are available as spares complete with mounting screws and seals. Coils and connectors should be ordered separately.

Order key, solenoid operators (22mm)

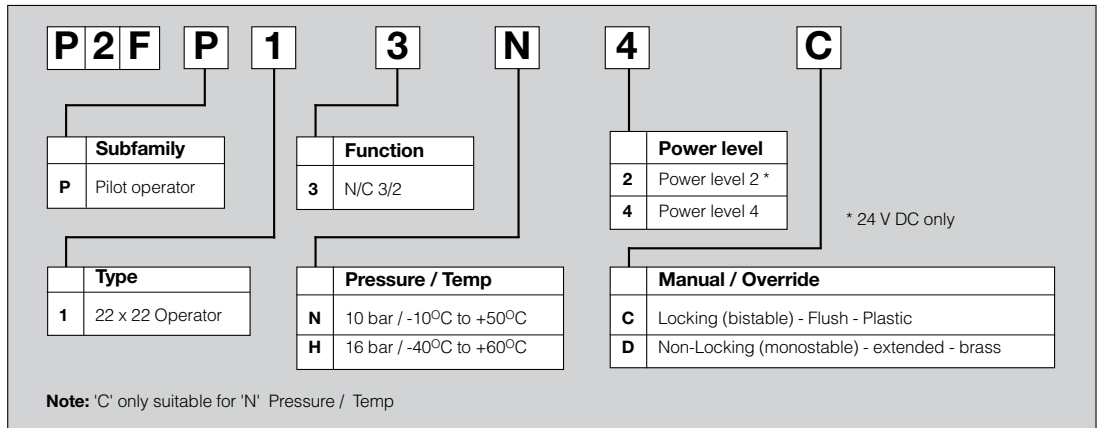

Technical data

	NC Normal	NC Xtreme	NC 22mm Xtreme (Mobile)	NC 30mm Xtreme (Mobile)
Working pressure	0 to 10 bar	0 to 16 bar	0 to 10 bar	0 to 16 bar
Ambient temperature	-10 °C to +50 °C	-40 °C to +60 °C	-40 °C to +60 °C	-40 °C to +60 °C
Orifice	1.3/1.5mm	0.8/1.0mm	0.8/1.0mm	0.8/1.0mm
Flow Qn @ 6 bar input 1 bar press drop. 1-2 l/m	55	20	20	20
Flow Qn @ 6 bar input 1 bar press drop. 2-3 l/m	70	30	30	30
Power (DC)	4.8W (2W Low power)	4.8W	6.0W	6.8W
Power (AC)	8.5VA	8.5VA		
Voltage tolerance (Standard)	+/- 10%	+/- 10%		
Voltage tolerance (Mobile)			-10 to +30%	+/- 30%
Duty cycle	100%	100%	100%	100%
Insulation class	F	F	F	F
Electric connection	Ind Form B	Ind Form B	Ind Form B	Form A
Protection	IP65	IP65	IP65	IP65
Shock & Vibration	-	0 to +5g	0 to +5g	0 to +5g
Approval	CSA/UL	CSA/UL	CSA/UL	CSA/UL
Working media	All neutral media such as compressed air and inert gases.			

Mobile applications

Solenoid operated Viking Xtreme duty valves for Mobile applications are fitted with the P2FP13H4D solenoid pilot operator. It has a 22mm footprint with 0.8/1.0mm orifice and will accept 22mm or 30mm coil options. The choice of coil option will depend on the voltage tolerance, operating ambient temperature range and maximum operating pressure. Use the technical data in the table above before selecting the coil type required, or contact our technical department.

Transients

Interrupting the current through the solenoid coil produces momentary voltage peaks which, under unfavourable conditions, can amount to several hundred times the rated operating voltage. Normally, these transients do not cause problems, but to achieve the maximum life of relays in the circuit (and particularly of transistors, thyristors and integrated circuits) it is desirable to provide protection by means of voltage-dependent resistors (varistors). All connectors/cable plugs with LED's listed on page 34 include this type of circuit protection.

Materials

Pilot Valve

Body:	Polyamide
Armature tube:	Brass (Normal) Stainless Steel 16 bar mobile
Plunger & core:	Corrosion resistant Cr-Ni steel
Seals:	FKM (Viton™)
Screws:	Stainless steel

Coil

Encapsulation material: Thermoplastic

22mm solenoid operator part numbers and spares

Solenoid coils for 22mm solenoid operators

Voltage	Order code Form A	Weight (Kg)	Order code Form B	Weight (Kg)
12V 60Hz			P2FCB440	0.093
24V 50/60Hz			P2FCB442	0.093
12V DC			P2FCB445	0.093
12V DC Mobile	P2FCA447	0.17	P2FCB447	0.093
24v DC Mobile	P2FCA448	0.17	P2FCB448	0.093
24V DC			P2FCB449	0.093
24V DC Low power			P2FCB249	0.093
48V DC			P2FCB451	0.093
110V/50Hz, 120V/60Hz			P2FCB453	0.093
230V/50Hz, 230V/60Hz			P2FCB457	0.093

Note: Mobile solenoids are only suitable for Viking Xtreme valves with 'H' specification having 0,8/1,0 operator type P2FP13H4D

Spare Solenoid Nuts

Valves requiring captured exhaust should be fitted with plastic knurled nut

Order code
P2FNP

Valves with vented exhaust are fitted with diffuser plastic nut

Order Code
P2FND

Spare Solenoid Operators

Solenoid pilot operator 22mm NC, Normal duty (Max Operating pressure 10bar, Temp -10°C to +50°C)

Order code (with locking bi-stable m/o)	weight Kg	Order code (with Non-locking monostable m/o)	weight Kg
P2FP13N4C	0.05kg	P2FP13N4D	0.05kg

Low power pilot operator NC, Normal duty (Max Operating pressure 10bar, Temp -10°C to +50°C)

Order code (with locking bi-stable m/o)	weight Kg	Order code (with Non-locking monostable m/o)	weight Kg
P2FP13N2C	0.05kg	P2FP13N2D	0.05kg

Solenoid pilot operator 22mm NC, Xtreme duty (Max Operating pressure 16bar, Temp -40°C to +60°C)



Order code (with Non-locking monostable m/o)	weight Kg
P2FP13H4D	0.05kg

Note.

Solenoid pilot operators are fitted to the Viking valve range. Order the above part numbers for spares. The operators are supplied with mounting screws and interface 'O' rings.

Coils and connectors must be ordered separately.

Solenoid Connectors / Cable Plugs EN175301-803

	Description	Order code 15mm Form C/ISO15217	Order code 22mm Industrial Form B	Order code 30mm Form A/ISO4400
With large headed screw suitable for mounting in inaccessible or recess position 	Standard IP65	P8C-C		
	24V DC LED and protection IP65	P8C-C26C		
	110V AC LED and protection IP65	P8C-C21E		
With standard screw 	Standard IP65 without flying lead	P8C-D	3EV10V10	3EV290V10
	With LED and protection 24V AC/DC	P8C-D26C	3EV10V20-24	3EV290V20-24
	With LED and protection 110V AC	P8C-D21E	3EV10V20-110	
	With LED and protection 230V AC		3EV10V20-230	
With cable 	Standard with 2m cable IP65	P8L-C2		
	Standard with 5m cable IP65	P8L-C5		
	24V AC/DC, 2m cable LED and protection IP65	P8L-C226C		
	24V AC/DC, 5m cable LED and protection IP65	P8L-C526C	3EV10V20-24L5	3EV290V20-24L5
	24V AC/DC, 10m cable LED and protection IP65	P8L-CA26C		
	110V AC/DC, 2m cable LED and protection IP65	P8L-C221E		
	110V AC/DC, 5m cable LED and protection IP65	P8L-C521E	3EV10V20-110L5	
	230V AC, 5m cable LED and protection IP65		3EV10V20-230L5	

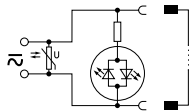
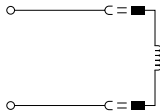

P8C-C
P8C-D
P8L-C2
P8L-C5
3EV10V10
3EV290V10

P8C-D26C	P8L-C226C
P8C-D21E	P8L-C526C
P8C-C26C	P8L-CA26C
P8C-C21E	P8L-C221E
	P8L-C521E
3EV10V20-24	3EV10V20-24L5
3EV10V20-110	3EV10V20-110L5
3EV10V20-230	3EV10V20-230L5

J

Cable Plug Dimensions (mm)

Solenoid operators P2E-+V...

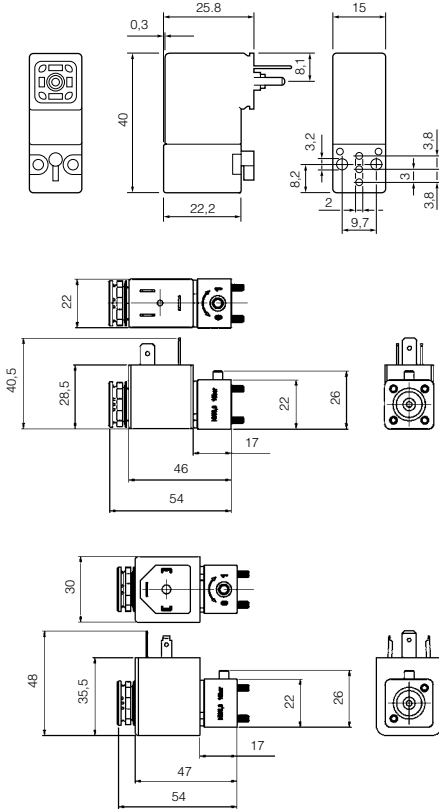

Cable plugs with cables

- P8C-C
- P8C-C26C
- P8C-C21E
- P8C-D
- P8C-D26C
- P8C-D21E

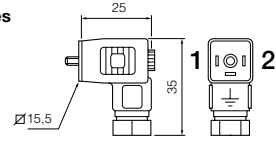

Cable plugs

- P8L-C2
- P8LC5
- P8L-C226C
- P8L-C526C
- P8L-CA26C
- P8L-C221E
- P8L-C521E

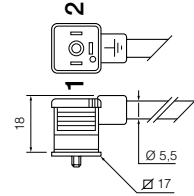

Cable plugs Form B

- 3EV10V10

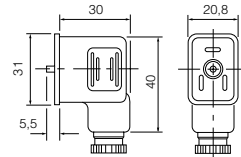

Cable plugs Form A

- 3EV290V10

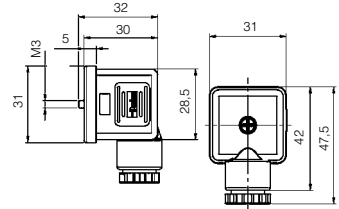

Accessories

Sintered bronze series

Port	Order code	Pack Qty
M5	9721900005	1
G1/8	9090050700	1
G1/4	P6M-BAA2	1
G3/8	9090050900	1
G1/2	9090051000	1

Male straight connectors - Parallel thread

Tube Ø1	Thread B	Order code	Box Qty
4	1/8	F4PMB4-1/8	20
6	1/8	F4PMB6-1/8	30
6	1/4	F4PMB6-1/4	30
8	1/8	F4PB8-1/8	40
8	1/4	F4PB8-1/4	30
8	3/8	F4PB8-3/8	20
10	1/4	F4PB10-1/4	20
10	3/8	F4PB10-3/8	20
10	1/2	F4PB10-1/2	10
12	1/4	F4PB12-1/4	10
12	3/8	F4PB12-3/8	10
12	1/2	F4PB12-1/2	10
14	3/8	F4PB14-3/8	10
14	1/2	F4PB14-1/2	10

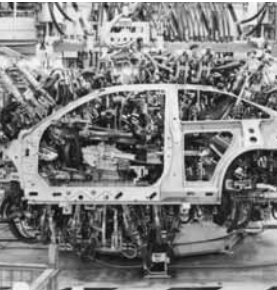

B Series Valves

High Flow Inline, Manifold Mounted,
Solenoid & Pilot Operated
G1/8 and G1/4 Body Ported

Compact installation dimensions - flexible installation

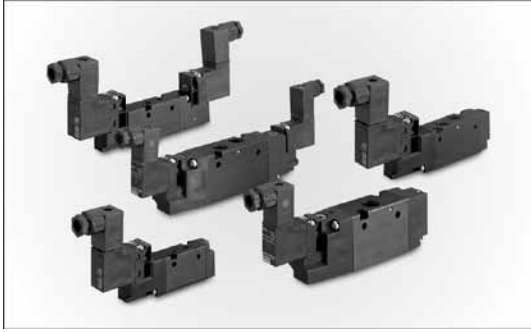

Compact dimensions, direct body porting and integral mounting holes are all features of the B series valve range. Valves may be mounted singly or on compact modular manifolds that can be extended to accommodate changes in the machine control system.

Manifold mounting



IEM stackable manifold system is designed to give maximum flexibility to system designers. Individual manifold bases stack together to form lightweight custom length manifold that can easily be modified to accommodate changes to system requirements.

High reliability

Valves easily comply with the requirements for component reliability in accordance with EU Machinery Directive standards EN292-2 and EN983.

A wide range of solenoid valves

Solenoid operated versions of the B3 & B4 valves are fitted with interface to accept the 15mm wide solenoid and Form C / ISO 15217 connector. The valve has small installation dimensions, low energy consumption. The B5 is also available with the 22mm wide solenoid suitable for (EN175301-803 form B) connector. The solenoid operators are available with or without manual overrides.

Different solenoid connector options

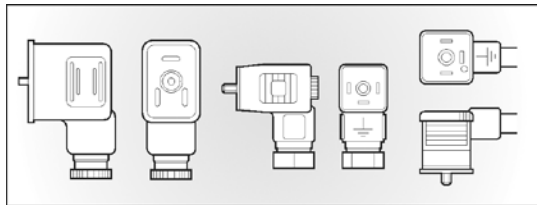

A large range of solenoid connectors are available with or without suppression, LED and rectifier and complete with moulded lead.

Maintenance

All B series valves have reliable function and long service life. Spare solenoid and repair kits are available.



WARNING

FAILURE OR IMPROPER SELECTION OR IMPROPER USE OF THE PRODUCTS AND/OR SYSTEMS DESCRIBED HEREIN OR RELATED ITEMS CAN CAUSE DEATH, PERSONAL INJURY AND PROPERTY DAMAGE.

This document and other information from Parker Hannifin Corporation, its subsidiaries and authorized distributors provide product and/or system options for further investigation by users having technical expertise. It is important that you analyze all aspects of your application and review the information concerning the product or system in the current product catalog. Due to the variety of operating conditions and applications for these products or systems, the user, through its own analysis and testing, is solely responsible for making the final selection of the products and systems and assuring that all performance, safety and warning requirements of the application are met. The products described herein, including without limitation, product features, specifications, designs, availability and pricing, are subject to change by Parker Hannifin Corporation and its subsidiaries at any time without notice.

SALE CONDITIONS

The items described in this document are available for sale by Parker Hannifin Corporation, its subsidiaries or its authorized distributors. Any sale contract entered into by Parker will be governed by the provisions stated in Parker's standard terms and conditions of sale (copy available upon request).

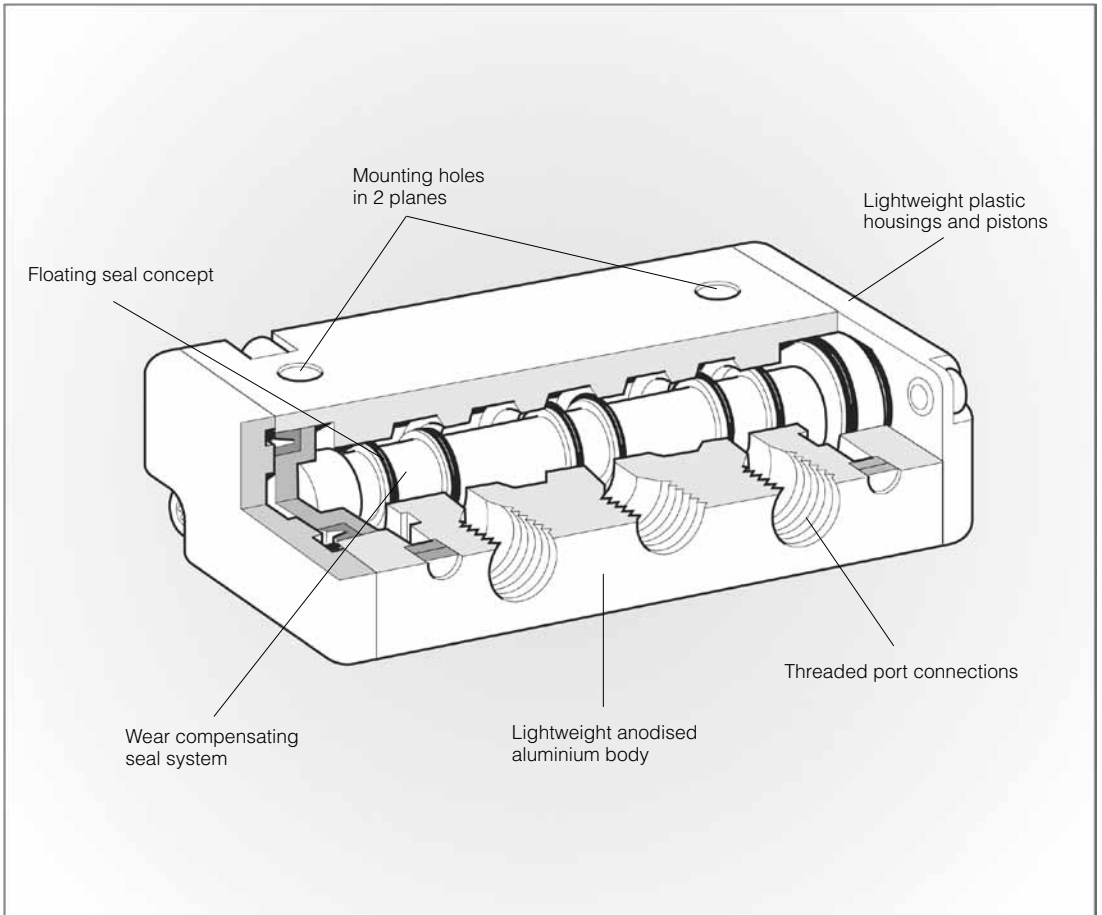

K



“Wear Compensating System”

The B series valves are fitted with dynamic bi-directional spool seals suitable for vacuum or pressures up to 10 bar. Under pressure radial expansion of the seal occurs to maintain sealing contact with the valve bore.

This sealing method reduces friction gives lower pilot pressures, fast response and less wear. Valves do not require lubrication in operation but they can also be installed in systems that are lubricated.

Flow characteristics

Flow capacities in accordance with ISO6358
 All pressures = effective pressure
 The curves in the diagram below are typical only

Technical Data B3

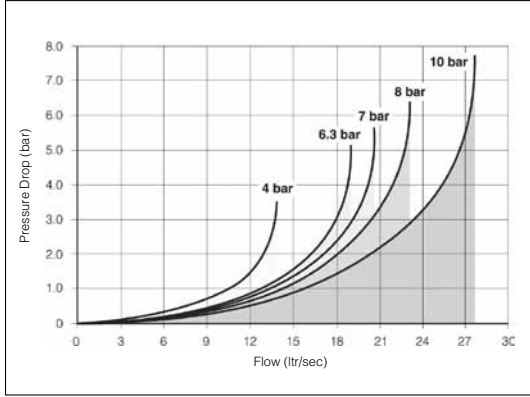

Port size	G1/8
Operating pressure.	Vacuum - 10 bar
Working temperature.	
Pneumatically operated valves.	-10°C to + 50°C
Solenoid operated valves.	-10°C to + 50°C
Response times:	
Single sol spring return	24/26ms
Single sol air spring return	13/15ms
Double solenoid operated	
Flow (acc. to ISO 6358)	
	c = 2.3
	b = 0.45
	Qn = 13 l/s
	Qmax = 16 l/s
	Cv = 0.75

Technical Data B4

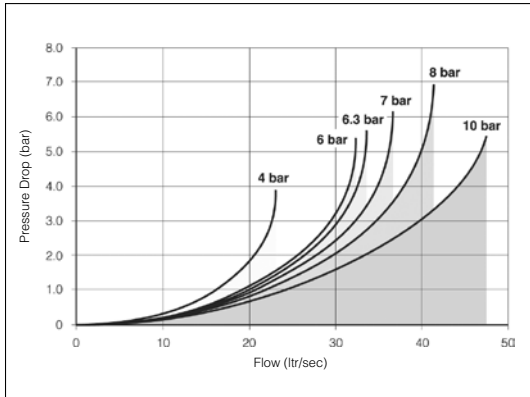

Port size	G1/4
Operating pressure.	Vacuum - 10 bar
Working temperature.	
Pneumatically operated valves.	-10°C to + 50°C
Solenoid operated valves.	-10°C to + 50°C
Response times:	
Single sol spring return	38/38ms
Single sol air spring return	23/24ms
Double solenoid operated	
Flow (acc. to ISO 6358)	
	c = 4.56
	b = 0.30
	Qn = 19.5 l/s
	Qmax = 32 l/s
	Cv = 1.2

Technical Data B5

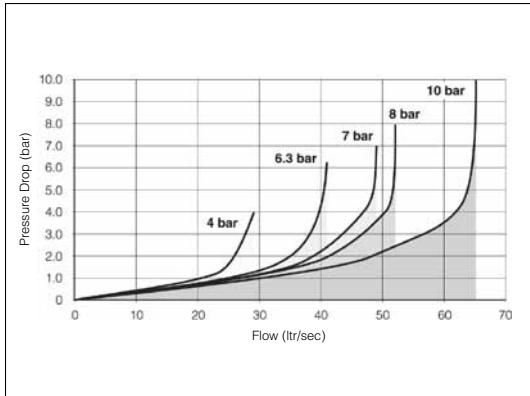

Port size	G1/4
Operating pressure.	Vacuum - 10 bar
Working temperature.	
Pneumatically operated valves.	-10°C to + 50°C
Solenoid operated valves.	-10°C to + 50°C
Response times:	
Single sol spring return	38/40ms
Single sol air spring return	16/18ms
Double solenoid operated	
Flow (acc. to ISO 6358)	
	Qn = 24 l/s
	Qmax = 37 l/s
	Cv = 1.4

B3 valve

Valve body	Anodised aluminium
End covers	Anodised aluminium or Reinforced thermoplastic
Spool	Aluminium + nitrile rubber
Piston	Acetal plastic/ Anodised aluminium
U-rings, O-rings	Nitrile rubber
End cover sealings	Nitrile rubber
End cover screws	Stainless steel
Springs	Dacromet® - processed steel, Stainless steel
Mounting screws for solenoid	Stainless steel

B3 Accessories

IEM manifold	Glass filled nylon
End plates	Anodised aluminium
Manifold connecting screws	Zinc plated steel

B5 valve

Valve body	Anodised aluminium
Spool	Aluminium + nitrile rubber
Piston	Brass
Lining	Brass
End covers	Anodised aluminium
Sliding seals	Thermoplastic
U-rings, O-rings	Nitrile rubber
End cover sealings	Nitrile rubber
End cover screws	Stainless steel
Springs	Stainless steel
Mounting screws for solenoid	Zinc plated steel

B5 Accessories

IEM manifold	Glass filled nylon
End plates	Anodised aluminium
Manifold connecting screws	Zinc plated steel

B4 valve

Valve body	Anodised aluminium
Spool	Acetal plastic/ Anodised aluminium
Piston	Acetal plastic /Anodised aluminium
Lining	Reinforced thermoplastic
End covers	Anodised aluminium
Sliding seals	Thermoplastic
U-rings, O-rings	Nitrile rubber
End cover sealings	Nitrile rubber
Push button for manual changeover	Acetal plastic
End cover screws	Stainless steel
Springs	Stainless steel
Mounting screws for solenoid	Zinc-plated steel

B4 Accessories

IEM manifold	Glass filled nylon
End plates	Anodised aluminium
Manifold connecting screws	Zinc plated steel



- G1/8 ports, 3/2, 5/2 and 5/3 functions
- Inlet-exhaust manifold facility
- DIN rail mounting
- Integral mounting holes
- 1.2 watt solenoid actuators
- FormC/ISO15217 connector



Operating information

Working pressure 10 bar max
 Working temperature; Pneumatically actuated -10°C to +60°C
 Electrically actuated -10°C to +50°C

Flow (3/2) and (5/2) (acc. to ISO 6358)

















C = 2,3
 b = 0,45
 Qn = 13 l/s
 Qmax = 16 l/s
 Cv = 0,6

K

B	3	2	5	B	B	5	49	H																																														
<table border="1" style="width:100%; border-collapse: collapse;"> <tr><th colspan="2">Basic series</th></tr> <tr><td>B3</td><td>Ported valve</td></tr> </table>		Basic series		B3	Ported valve	<table border="1" style="width:100%; border-collapse: collapse;"> <tr><th colspan="2">Port size</th></tr> <tr><td>5</td><td>G1/8</td></tr> </table>		Port size		5	G1/8	<table border="1" style="width:100%; border-collapse: collapse;"> <tr><th colspan="2">Pilot source / Exh / Pilot exhaust</th></tr> <tr><td>0</td><td>None (Air pilot only)</td></tr> <tr><td>B</td><td>Port 1 / Vented / Side</td></tr> </table>				Pilot source / Exh / Pilot exhaust		0	None (Air pilot only)	B	Port 1 / Vented / Side	<table border="1" style="width:100%; border-collapse: collapse;"> <tr><th colspan="2">Solenoid overrides / Lights</th></tr> <tr><td>0</td><td>None (Air pilot only)</td></tr> <tr><td>B</td><td>Spring return, flush without light</td></tr> <tr><td>C</td><td>Locking, flush without light</td></tr> <tr><td>X</td><td>None (Solenoid valve less solenoid)</td></tr> </table>			Solenoid overrides / Lights		0	None (Air pilot only)	B	Spring return, flush without light	C	Locking, flush without light	X	None (Solenoid valve less solenoid)																				
Basic series																																																						
B3	Ported valve																																																					
Port size																																																						
5	G1/8																																																					
Pilot source / Exh / Pilot exhaust																																																						
0	None (Air pilot only)																																																					
B	Port 1 / Vented / Side																																																					
Solenoid overrides / Lights																																																						
0	None (Air pilot only)																																																					
B	Spring return, flush without light																																																					
C	Locking, flush without light																																																					
X	None (Solenoid valve less solenoid)																																																					
<table border="1" style="width:100%; border-collapse: collapse;"> <tr><th colspan="2">Operator function</th></tr> <tr><th colspan="2">3 Port</th></tr> <tr><td>G</td><td> 3/2 N/C Single sol - air differential return</td></tr> <tr><td>J</td><td> 3/2 Double solenoid</td></tr> <tr><td>K</td><td> 3/2 N/C Remote air pilot - air differential return</td></tr> <tr><td>M</td><td> 3/2 Double remote air pilot</td></tr> <tr><td>R</td><td> 3/2 N/C Single sol - spring return</td></tr> <tr><td>S</td><td> 3/2 N/C Single sol - remote air pilot return</td></tr> <tr><td>U</td><td> 3/2 N/C Remote air pilot - spring return</td></tr> <tr><th colspan="2">5 Port</th></tr> <tr><td>1</td><td> 5/2 Single sol - air differential return</td></tr> <tr><td>2</td><td> 5/2 Double solenoid</td></tr> <tr><td>3</td><td> 5/2 Remote air pilot - air differential return</td></tr> <tr><td>4</td><td> 5/2 Double remote air pilot</td></tr> <tr><td>5</td><td> 5/3 Double solenoid - all ports blocked (APB)</td></tr> <tr><td>6</td><td> 5/3 Double solenoid - cyl to exhaust ports (CE)</td></tr> <tr><td>7</td><td> 5/3 Double solenoid - press to cylinder ports (PC)</td></tr> <tr><td>8</td><td> 5/3 Double remote operated - all ports blocked (APB)</td></tr> <tr><td>9</td><td> 5/3 Double remote operated - (CE) ①</td></tr> <tr><td>0</td><td> 5/3 Double remote operated - (PC) ②</td></tr> <tr><td>A</td><td> 5/2 Single sol - remote air pilot return</td></tr> <tr><td>P</td><td> 5/2 Remote air pilot - spring return</td></tr> <tr><td>T</td><td> 5/2 Single sol - spring return</td></tr> </table>									Operator function		3 Port		G	3/2 N/C Single sol - air differential return	J	3/2 Double solenoid	K	3/2 N/C Remote air pilot - air differential return	M	3/2 Double remote air pilot	R	3/2 N/C Single sol - spring return	S	3/2 N/C Single sol - remote air pilot return	U	3/2 N/C Remote air pilot - spring return	5 Port		1	5/2 Single sol - air differential return	2	5/2 Double solenoid	3	5/2 Remote air pilot - air differential return	4	5/2 Double remote air pilot	5	5/3 Double solenoid - all ports blocked (APB)	6	5/3 Double solenoid - cyl to exhaust ports (CE)	7	5/3 Double solenoid - press to cylinder ports (PC)	8	5/3 Double remote operated - all ports blocked (APB)	9	5/3 Double remote operated - (CE) ①	0	5/3 Double remote operated - (PC) ②	A	5/2 Single sol - remote air pilot return	P	5/2 Remote air pilot - spring return	T	5/2 Single sol - spring return
Operator function																																																						
3 Port																																																						
G	3/2 N/C Single sol - air differential return																																																					
J	3/2 Double solenoid																																																					
K	3/2 N/C Remote air pilot - air differential return																																																					
M	3/2 Double remote air pilot																																																					
R	3/2 N/C Single sol - spring return																																																					
S	3/2 N/C Single sol - remote air pilot return																																																					
U	3/2 N/C Remote air pilot - spring return																																																					
5 Port																																																						
1	5/2 Single sol - air differential return																																																					
2	5/2 Double solenoid																																																					
3	5/2 Remote air pilot - air differential return																																																					
4	5/2 Double remote air pilot																																																					
5	5/3 Double solenoid - all ports blocked (APB)																																																					
6	5/3 Double solenoid - cyl to exhaust ports (CE)																																																					
7	5/3 Double solenoid - press to cylinder ports (PC)																																																					
8	5/3 Double remote operated - all ports blocked (APB)																																																					
9	5/3 Double remote operated - (CE) ①																																																					
0	5/3 Double remote operated - (PC) ②																																																					
A	5/2 Single sol - remote air pilot return																																																					
P	5/2 Remote air pilot - spring return																																																					
T	5/2 Single sol - spring return																																																					
<table border="1" style="width:100%; border-collapse: collapse;"> <tr><th colspan="2">Solenoid Enclosures</th></tr> <tr><td>0</td><td>None (Air pilot only)</td></tr> <tr><td>5</td><td>15mm connector</td></tr> <tr><td>X</td><td>None</td></tr> </table>									Solenoid Enclosures		0	None (Air pilot only)	5	15mm connector	X	None																																						
Solenoid Enclosures																																																						
0	None (Air pilot only)																																																					
5	15mm connector																																																					
X	None																																																					
<table border="1" style="width:100%; border-collapse: collapse;"> <tr><th colspan="2">Pilot operator / Coil voltage¹</th></tr> <tr><td>39</td><td>12V 50Hz</td></tr> <tr><td>43</td><td>24V 50Hz</td></tr> <tr><td>44</td><td>48V 50Hz</td></tr> <tr><td>45</td><td>12V DC</td></tr> <tr><td>49</td><td>24V DC</td></tr> <tr><td>53</td><td>110V 50Hz</td></tr> <tr><td>57</td><td>220V 50Hz</td></tr> <tr><td>XX</td><td>Valve less solenoid operator</td></tr> </table>									Pilot operator / Coil voltage ¹		39	12V 50Hz	43	24V 50Hz	44	48V 50Hz	45	12V DC	49	24V DC	53	110V 50Hz	57	220V 50Hz	XX	Valve less solenoid operator																												
Pilot operator / Coil voltage ¹																																																						
39	12V 50Hz																																																					
43	24V 50Hz																																																					
44	48V 50Hz																																																					
45	12V DC																																																					
49	24V DC																																																					
53	110V 50Hz																																																					
57	220V 50Hz																																																					
XX	Valve less solenoid operator																																																					
<p>Shaded part numbers are standard</p>																																																						
<table border="1" style="width:100%; border-collapse: collapse;"> <tr><th colspan="2">Engineering level H</th></tr> <tr><td>①</td><td>Cyl to exhaust ports (CE)</td></tr> <tr><td>②</td><td>Press to cylinder ports (PC)</td></tr> </table>									Engineering level H		①	Cyl to exhaust ports (CE)	②	Press to cylinder ports (PC)																																								
Engineering level H																																																						
①	Cyl to exhaust ports (CE)																																																					
②	Press to cylinder ports (PC)																																																					

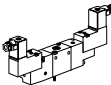

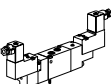

¹ Shaded part numbers are standard
 Unshaded part numbers are available on request but will be subject to minimum order quantities
 Otherwise order XX version and order solenoid separately.

Main data for Directional control valves, B3 Series

Symbol	Actuator	Return	Signal pressure min, bar at 6 bar actua./return	Changeover time, ms at 6 bar actua./return	Weight Kg	Voltage	Order code	Qty
Pneumatically actuated 3/2 valves								
	Air	Differential air	1,4/-	16/17	0,07		B3K5000XXH	1
	Air	Spring return	3,0/-	20/18	0,07		B3U5000XXH	1
	Air	Air	1,4/-	2/2	0,08		B3M5000XXH	1
Pneumatically actuated 5/2 and 5/3 valves								
	Air	Differential air	1,4/-	16/17	0,09		B335000XXH	1
	Air	Spring return	3,0/-	20/18	0,09		B3P5000XXH	1
	Air	Air	1,4/1,4	2/2	0,10		B345000XXH	1
	Air	Self centring	3,0/3,0	12/12	0,10		B385000XXH	1
	Air	Self centring	3,0/3,0	12/12	0,10		B395000XXH	1
	Air	Self centring	3,0/3,0	12/12	0,10		B305000XXH	1
Electrically actuated 3/2 valves								
	Electric	Differential air	1,4/-	12/14	0,12 0,08	24 VDC Less solenoid	B3G5BB549H B3G5BXXXXH	1 1
	Electric	Spring return	3,0/-	22/28	0,12 0,08	24 VDC Less solenoid	B3R5BB549H B3R5BXXXXH	1 1
	Electric	Air	1,4/1/4	9/3	0,13 0,09	24 VDC Less solenoid	B3S5BB549H B3S5BXXXXH	1 1
	Electric	Electric	1,4/1/4	8/8	0,13 0,09	24 VDC Less solenoid	B3J5BB549H B3J5BXXXXH	1 1
Electrically actuated 5/2 valves								
	Electric	Differential	1,4/-	12/14	0,12	24 VDC	B315BB549H	1
	Air	Air	1,4/-	12/14	0,09	Less solenoid	B315BXXXXH	1
	Electric	Spring return	3,0/-	22/28	0,12 0,09	24 VDC Less solenoid	B3T5BB549H B3T5BXXXXH	1 1
	Electric	Air	1,4/1/4	9/3	0,14 0,10	24 VDC Less solenoid	B3A5BB549H B3A5BXXXXH	1 1
	Electric	Electric	1,4/1/4	8/8	0,19 0,10	24 VDC Less solenoid	B325BB549H B325BXXXXH	1 1

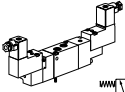
K

Main data for Directional control valves, B3 Series

Symbol	Actuator	Return	Signal pressure min, bar at 6 bar actua./return	Changeover time, ms at 6 bar actua./return	Weight Kg	Voltage	Order code	Qty
Electrically actuated 5/3 valves								
 	Electric	Electric	3,0/3,0	12/12	0,18	24 VDC	B355BB549H	1
	Closed centre position	Self centring			0,09	Less solenoid	B355BXXXXH	1
	Electric	Electric	3,0/3,0	12/12	0,18	24 VDC	B365BB549H	1
	Vented centre position	Self centring			0,09	Less solenoid	B365BXXXXH	1
	Electric	Electric	3,0/3,0	12/12	0,10	24 VDC	B375BB549H	1
	Pressurised centre position	Self centring			0,09	Less solenoid	B375BXXXXH	1

Internal air supply to differential pilots and solenoids via port 1

Silencers and push-in fittings are shown on page 27.

Valves supplied with solenoid operators include standard P8C-D connector

K

Inlet Exhaust Manifolds for B3 series valves

Standard Base without Flow Controls

- Each kit contains:
- 1 pcs Manifold Base
- 2 pcs Mounting screws and nuts
- 3 pcs Tie Rods
- 1 pcs Body-to-base Gasket and
- 1 pcs Base-to-Base Gasket

		Order code	Qty
Manifold Base	3/2 =	PS2948F	1
Kit	5/2 =	PS2917F	1

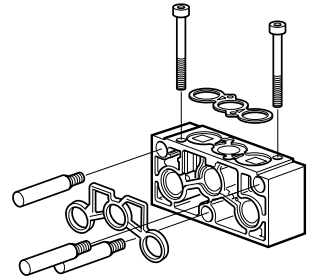

End plates

Standard End Plates may be used with either of above Manifold Bases

- Each kit contains:
- 1 right and 1 left End Plate
- 3 pcs O-Rings
- 3 pcs Blanking Plugs
- 3 pcs Socket Head Cap Screws
- 3 pcs Flat Washers
- 3 pcs Lockwashers

		Order code	Qty
Manifold End	3/2 =	PS2951F	1
plate kit	5/2 =	PS2916F	1

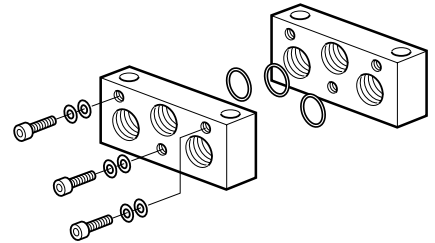

K

Isolator Plug Kit

Used to isolate the 1, 3 or 5 gallery between two Manifold Bases

- Each kit contains:
- 3 pcs Isolator Plugs complete with O-rings.

		Order code	Qty
Isolator Plug Kit		PS2919F	1

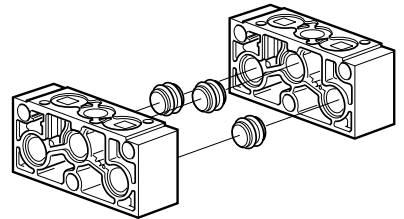

Manifold Blanking Plate

- Each kit contains:
- 1 pcs Cover Plate
- 2 pcs Mounting Screws
- 1 pcs Gasket
- Used to blank off unused stations.

		Order code	Qty
Manifold	3/2 =	PS2968F	1
Blanking Plate	5/2 =	PS2969F	1

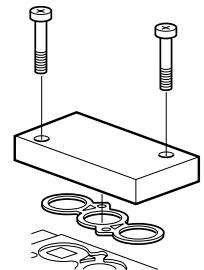

Dimensions, B3 Valve Series

3/2 Body ported
Single solenoid operated air spring return / spring return

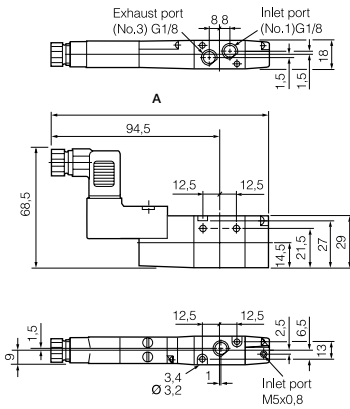

	Air differential return	Spring return
A	130,5	136,7

Double solenoid operated

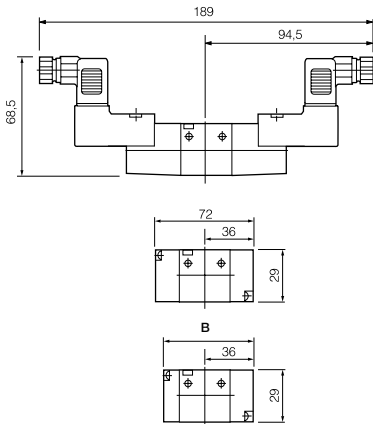

	Air differential return	Spring return
B	67,0	73,2

5/2 Body ported
Single solenoid operated air spring return / spring return

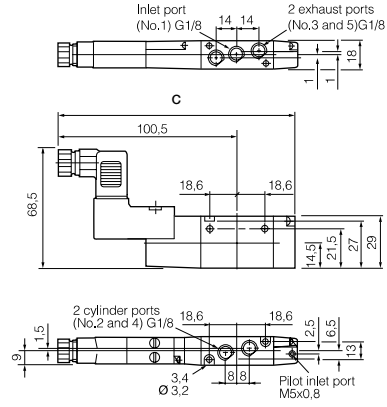

	Air differential return	Spring return
C	137,5	143,7

Double solenoid operated

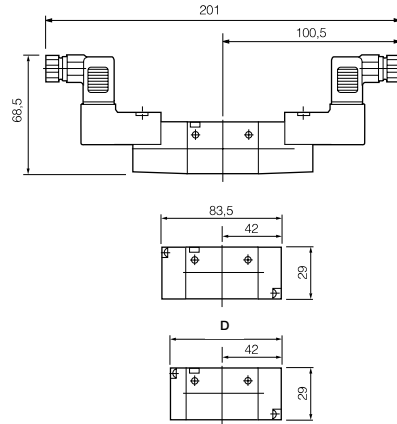

	Air differential return	Spring return
D	79,0	85,2

All dimensions in mm unless otherwise stated

Dimensions, B3 Valve Series

5/3 Body ported

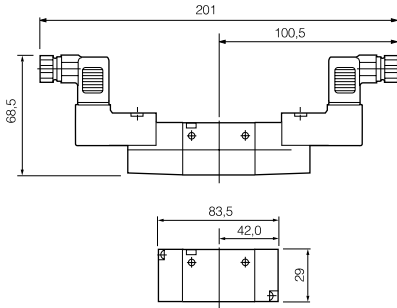

Manifolds - IEM Inlet Exhaust Manifold System

**3/2 Inlet Exhaust Manifold
 For B3 Body Ported Valves**

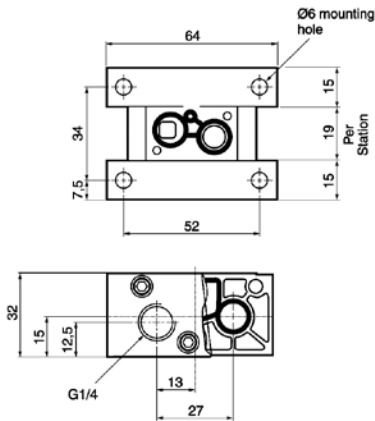

**5/2 Inlet Exhaust Manifold
 For B3 Body Ported Valves**

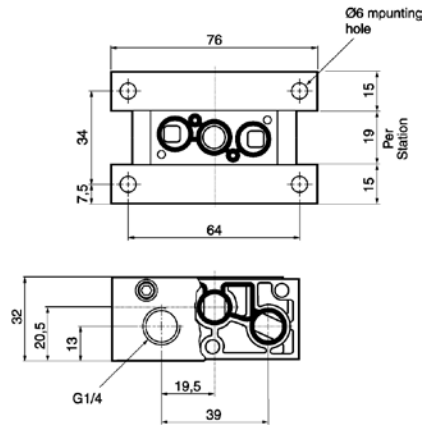

All dimensions in mm unless otherwise stated

K

- G1/4 ports, 3/2, 5/2 and 5/3 functions
- Inlet-exhaust manifold facility
- DIN rail mounting
- Integral mounting holes
- 1.2 watt solenoid actuators
- Form C / ISO 15217 connector



Operating information

Working pressure	Max 10 bar	Flow (3/2) and (5/2) (acc. to ISO 6358)	C = 4,56
Working temperature; Pneumatically actuated	-10°C to +60°C		b = 0,30
Electrically actuated	-10°C to +50°C		Qn = 19,5 l/s
			Cv = 1,2























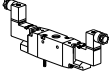

K

<table border="1" style="width: 100%; border-collapse: collapse;"> <tr><td style="text-align: center; font-weight: bold;">B</td><td style="text-align: center; font-weight: bold;">4</td></tr> <tr><td colspan="2" style="text-align: center;">Basic series</td></tr> <tr><td style="text-align: center;">B4</td><td style="text-align: center;">Ported valve</td></tr> </table>	B	4	Basic series		B4	Ported valve	<table border="1" style="width: 100%; border-collapse: collapse;"> <tr><td style="text-align: center; font-weight: bold;">2</td></tr> <tr><td colspan="2" style="text-align: center;">Port size</td></tr> <tr><td style="text-align: center;">6</td><td style="text-align: center;">G1/4</td></tr> </table>	2	Port size		6	G1/4	<table border="1" style="width: 100%; border-collapse: collapse;"> <tr><td style="text-align: center; font-weight: bold;">B</td><td style="text-align: center; font-weight: bold;">5</td><td style="text-align: center; font-weight: bold;">49</td><td style="text-align: center; font-weight: bold;">F</td></tr> <tr><td colspan="4" style="text-align: center;">Pilot source / Exh / Pilot exhaust</td></tr> <tr><td style="text-align: center;">0</td><td colspan="3">None (Air pilot only)</td></tr> <tr><td style="text-align: center;">A</td><td colspan="3">Port 1 / Tapped / Side</td></tr> </table>	B	5	49	F	Pilot source / Exh / Pilot exhaust				0	None (Air pilot only)			A	Port 1 / Tapped / Side																																									
B	4																																																																			
Basic series																																																																				
B4	Ported valve																																																																			
2																																																																				
Port size																																																																				
6	G1/4																																																																			
B	5	49	F																																																																	
Pilot source / Exh / Pilot exhaust																																																																				
0	None (Air pilot only)																																																																			
A	Port 1 / Tapped / Side																																																																			
<table border="1" style="width: 100%; border-collapse: collapse;"> <tr><td colspan="2" style="text-align: center;">Operator function</td></tr> <tr><td colspan="2">3 Port</td></tr> <tr><td style="text-align: center;">G</td><td>3/2 N/C Single sol - air differential return</td></tr> <tr><td style="text-align: center;">J</td><td>3/2 Double solenoid</td></tr> <tr><td style="text-align: center;">K</td><td>3/2 N/C Remote air pilot - air differential return</td></tr> <tr><td style="text-align: center;">M</td><td>3/2 Double remote air pilot</td></tr> <tr><td style="text-align: center;">R</td><td>3/2 N/C Single sol - spring return</td></tr> <tr><td style="text-align: center;">S</td><td>3/2 N/C Single sol - remote air pilot return</td></tr> <tr><td style="text-align: center;">U</td><td>3/2 N/C Remote air pilot - spring return</td></tr> <tr><td colspan="2">5 Port</td></tr> <tr><td style="text-align: center;">1</td><td>5/2 Single sol - air differential return</td></tr> <tr><td style="text-align: center;">2</td><td>5/2 Double solenoid</td></tr> <tr><td style="text-align: center;">3</td><td>5/2 Remote air pilot - air differential return</td></tr> <tr><td style="text-align: center;">4</td><td>5/2 Double remote air pilot</td></tr> <tr><td style="text-align: center;">5</td><td>5/3 Double solenoid - all ports blocked (APB)</td></tr> <tr><td style="text-align: center;">6</td><td>5/3 Double solenoid - cyl to exhaust ports (CE)</td></tr> <tr><td style="text-align: center;">7</td><td>5/3 Double solenoid - press to cylinder ports (PC)</td></tr> <tr><td style="text-align: center;">8</td><td>5/3 Double remote operated - all ports blocked (APB)</td></tr> <tr><td style="text-align: center;">9</td><td>5/3 Double remote operated - (CE) ①</td></tr> <tr><td style="text-align: center;">0</td><td>5/3 Double remote operated - (PC) ②</td></tr> <tr><td style="text-align: center;">A</td><td>5/2 Single sol - remote air pilot return</td></tr> <tr><td style="text-align: center;">P</td><td>5/2 Remote air pilot - spring return</td></tr> <tr><td style="text-align: center;">T</td><td>5/2 Single sol - spring return</td></tr> </table>		Operator function		3 Port		G	3/2 N/C Single sol - air differential return	J	3/2 Double solenoid	K	3/2 N/C Remote air pilot - air differential return	M	3/2 Double remote air pilot	R	3/2 N/C Single sol - spring return	S	3/2 N/C Single sol - remote air pilot return	U	3/2 N/C Remote air pilot - spring return	5 Port		1	5/2 Single sol - air differential return	2	5/2 Double solenoid	3	5/2 Remote air pilot - air differential return	4	5/2 Double remote air pilot	5	5/3 Double solenoid - all ports blocked (APB)	6	5/3 Double solenoid - cyl to exhaust ports (CE)	7	5/3 Double solenoid - press to cylinder ports (PC)	8	5/3 Double remote operated - all ports blocked (APB)	9	5/3 Double remote operated - (CE) ①	0	5/3 Double remote operated - (PC) ②	A	5/2 Single sol - remote air pilot return	P	5/2 Remote air pilot - spring return	T	5/2 Single sol - spring return	<table border="1" style="width: 100%; border-collapse: collapse;"> <tr><td colspan="2" style="text-align: center;">Solenoid overrides / Lights</td></tr> <tr><td style="text-align: center;">0</td><td>None (Air pilot only)</td></tr> <tr><td style="text-align: center;">B</td><td>Spring return, flush without light</td></tr> <tr><td style="text-align: center;">C</td><td>Locking, flush without light</td></tr> <tr><td style="text-align: center;">X</td><td>None (Solenoid valve less solenoid)</td></tr> </table>		Solenoid overrides / Lights		0	None (Air pilot only)	B	Spring return, flush without light	C	Locking, flush without light	X	None (Solenoid valve less solenoid)	<table border="1" style="width: 100%; border-collapse: collapse;"> <tr><td colspan="2" style="text-align: center;">Solenoid Enclosures</td></tr> <tr><td style="text-align: center;">0</td><td>None (Air pilot only)</td></tr> <tr><td style="text-align: center;">5</td><td>15mm connector</td></tr> <tr><td style="text-align: center;">X</td><td>None (Valve less 15mm solenoid)</td></tr> </table>	Solenoid Enclosures		0	None (Air pilot only)	5	15mm connector	X	None (Valve less 15mm solenoid)
Operator function																																																																				
3 Port																																																																				
G	3/2 N/C Single sol - air differential return																																																																			
J	3/2 Double solenoid																																																																			
K	3/2 N/C Remote air pilot - air differential return																																																																			
M	3/2 Double remote air pilot																																																																			
R	3/2 N/C Single sol - spring return																																																																			
S	3/2 N/C Single sol - remote air pilot return																																																																			
U	3/2 N/C Remote air pilot - spring return																																																																			
5 Port																																																																				
1	5/2 Single sol - air differential return																																																																			
2	5/2 Double solenoid																																																																			
3	5/2 Remote air pilot - air differential return																																																																			
4	5/2 Double remote air pilot																																																																			
5	5/3 Double solenoid - all ports blocked (APB)																																																																			
6	5/3 Double solenoid - cyl to exhaust ports (CE)																																																																			
7	5/3 Double solenoid - press to cylinder ports (PC)																																																																			
8	5/3 Double remote operated - all ports blocked (APB)																																																																			
9	5/3 Double remote operated - (CE) ①																																																																			
0	5/3 Double remote operated - (PC) ②																																																																			
A	5/2 Single sol - remote air pilot return																																																																			
P	5/2 Remote air pilot - spring return																																																																			
T	5/2 Single sol - spring return																																																																			
Solenoid overrides / Lights																																																																				
0	None (Air pilot only)																																																																			
B	Spring return, flush without light																																																																			
C	Locking, flush without light																																																																			
X	None (Solenoid valve less solenoid)																																																																			
Solenoid Enclosures																																																																				
0	None (Air pilot only)																																																																			
5	15mm connector																																																																			
X	None (Valve less 15mm solenoid)																																																																			
<table border="1" style="width: 100%; border-collapse: collapse;"> <tr><td colspan="2" style="text-align: center;">Pilot operator / Coil voltage¹</td></tr> <tr><td style="text-align: center;">39</td><td>12V 50Hz</td></tr> <tr><td style="text-align: center;">43</td><td>24V 50Hz</td></tr> <tr><td style="text-align: center;">44</td><td>48V 50Hz</td></tr> <tr><td style="text-align: center;">45</td><td>12V DC</td></tr> <tr><td style="text-align: center;">49</td><td>24V DC</td></tr> <tr><td style="text-align: center;">53</td><td>110V 50Hz</td></tr> <tr><td style="text-align: center;">57</td><td>220V 50Hz</td></tr> <tr><td style="text-align: center;">XX</td><td>Valve less solenoid operator</td></tr> </table>		Pilot operator / Coil voltage¹		39	12V 50Hz	43	24V 50Hz	44	48V 50Hz	45	12V DC	49	24V DC	53	110V 50Hz	57	220V 50Hz	XX	Valve less solenoid operator	<table border="1" style="width: 100%; border-collapse: collapse;"> <tr><td colspan="2" style="text-align: center;">Engineering level F</td></tr> <tr><td colspan="2" style="text-align: center;">① Cyl to exhaust ports (CE)</td></tr> <tr><td colspan="2" style="text-align: center;">② Press to cylinder ports (PC)</td></tr> </table>		Engineering level F		① Cyl to exhaust ports (CE)		② Press to cylinder ports (PC)																																										
Pilot operator / Coil voltage¹																																																																				
39	12V 50Hz																																																																			
43	24V 50Hz																																																																			
44	48V 50Hz																																																																			
45	12V DC																																																																			
49	24V DC																																																																			
53	110V 50Hz																																																																			
57	220V 50Hz																																																																			
XX	Valve less solenoid operator																																																																			
Engineering level F																																																																				
① Cyl to exhaust ports (CE)																																																																				
② Press to cylinder ports (PC)																																																																				





Shaded part numbers are standard

¹ Shaded part numbers are standard
Unshaded part numbers are available on request but will be subject to minimum order quantities
Otherwise order XX version and order solenoid separately.

Main data for Directional control valves, B4 Series

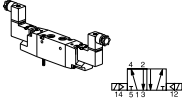
Symbol	Actuator	Return	Signal pressure min, bar at 6 bar actua./return	Changeover time, ms at 6 bar actua./return	Weight Kg	Voltage	Order code	Qty	
Pneumatically actuated 3/2 valves									
		Air	Differential air	1,5/-	34/45	0,163	B4K6000XXF	1	
		Air	Spring return	3,0/-	32/48	0,16	B4U6000XXF	1	
		Air	Air	1,5/1,5	15/17	0,177	B4M6000XXF	1	
Pneumatically actuated 5/2 and 5/3 valves									
		Air	Differential air	1,5/-	34/45	0,184	B436000XXF	1	
		Air	Spring return	3,0/-	32/48	0,19	B4P6000XXF	1	
		Air	Air	1,5/1,5	15/17	0,198	B446000XXF	1	
		Air	Air	3,0/3,0	16/19	0,204	B486000XXF	1	
		Closed centre	Self centring position						
		Vented centre	Self centring position	3,0/3,0	16/19	0,204	B496000XXF	1	
		Pressurised centre	Self centring position	3,0/3,0	16/19	0,204	B406000XXF	1	
Electrically actuated 3/2 valves									
		Electric	Differential air	1,5/-	34/45	0,206 0,157	24 VDC Less solenoid	B4G6AB549F B4G6AXXXXF	1 1
		Electric	Spring return	3,0/-	36/40	0,210 0,161	24 VDC Less solenoid	B4R6AB549F B4R6AXXXXF	1 1
		Electric	Air	1,5/1,5	15/17	0,220 0,170	24 VDC Less solenoid	B4S6AB549F B4S6AXXXXF	1 1
		Electric	Electric	1,5/1/5	15/17	0,262 0,164	24 VDC Less solenoid	B4J6AB549F B4J6AXXXXF	1 1
Electrically actuated 5/2 valves									
		Electric	Differential	1,5/-	34/45	0,227	24 VDC	B416AB549F	1
		Air	Air			0,178	Less solenoid	B416AXXXXF	1
		Electric	Spring return	3,0/-	36/40	0,227	24 VDC	B4T6AB549F	1
		Air	Air			0,178	Less solenoid	B4T6AXXXXF	1
		Electric	Air	1,5/1/5	15/17	0,241 0,192	24 VDC Less solenoid	B4A6AB549F B4A6AXXXXF	1 1

K

Symbol	Actuator	Return	Signal pressure min, bar at 6 bar actua./return	Changeover time, ms at 6 bar actua./return	Weight Kg	Voltage	Order code	Qty
Electrically actuated 5/2 and 5/3 valves								
	Electric	Electric	1,5/1,5	15/15	0,283	24 VDC	B426AB549F	1
						0,185	Less solenoid	B426AXXXF
	Electric	Electric	3,0/3,0	16/18	0,289	24 VDC	B456AB549F	1
	Closed centre position	Self centring				0,191	Less solenoid	B456AXXXF
	Electric	Electric	3,0/3,0	16/18	0,289	24 VDC	B466AB549F	1
	Vented centre position	Self centring				0,191	Less solenoid	B466AXXXF
	Electric	Electric	3,0/3,0	16/18	0,289	24 VDC	B476AB549F	1
	Pressurised centre position	Self centring				0,191	Less solenoid	B476AXXXF

Internal air supply to differential pilots and solenoids via port 1

Silencers and push-in fittings are shown on page 27.

Valves supplied with solenoid operators include standard P8C-D connector

K

Inlet Exhaust Manifolds for B4 series valves

Standard Base without Flow Controls

Each kit contains:

- 1 pcs Manifold Base
- 2 pcs Mounting screws and nuts
- 2 pcs Tie Rods
- 1 pcs Body-to-base Gasket and
- 1 pcs Base-to-Base Gasket

	Order code	Qty
Manifold Base Kit	3/2 = PS4548F	1
	5/2 = PS4517F	1

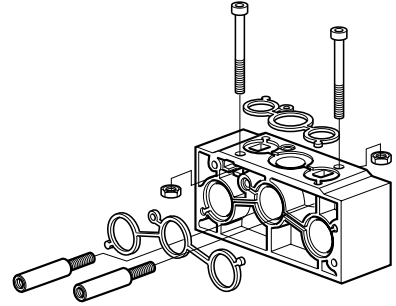

End plates

Standard End Plates may be used with either of above Manifold Bases

Each kit contains:

- 1 right and 1 left End Plate
- 3 pcs O-Rings
- 3 pcs Blanking Plugs
- 2 pcs Socket Head Cap Screws
- 2 pcs Flat Washers
- 2 pcs Lockwashers

	Port Size	Order code	Qty
Manifold End plate kit	3/8 BSP	3/2 = PS4551F	1
	3/8 BSP	5/2 = PS4516F	1

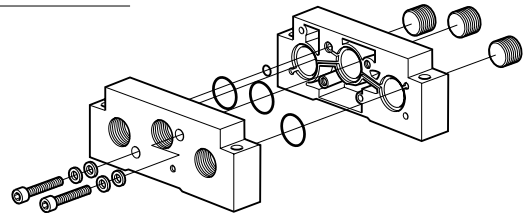

K

Isolator Plug Kit

Used to isolate the 1, 3 or 5 gallery between two Manifold Bases

Each kit contains:

- 3 pcs Isolator Plugs complete with O-rings

	Order code	Qty
Isolator Plug kit	PS4519F	1

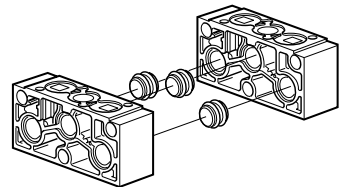

Manifold Blanking plate

Each kit contains:

- 1 pcs Cover Plate
- 2 pcs Mounting Screws
- 1 pcs Gasket

Used to blank off unused stations.

	Order code	Qty
Manifold Blanking plate	3/2 = PS4568F	1
	5/2 = PS4569F	1

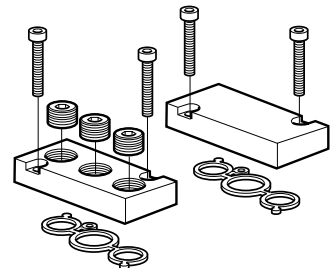

Dimensions, B4 Valve Series

3/2 Body ported

Single solenoid operated air spring return / spring return

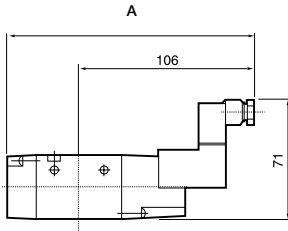

	Air differential return	Spring return
A	154,0	156,0

5/2 Body ported

Single solenoid operated air spring return / spring return

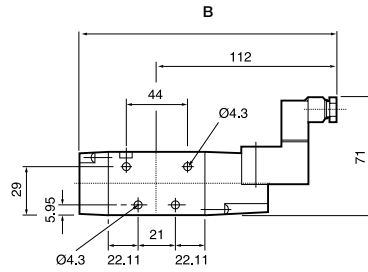

	Air differential return	Spring return
B	166,0	168,0

Single solenoid operated air pilot return

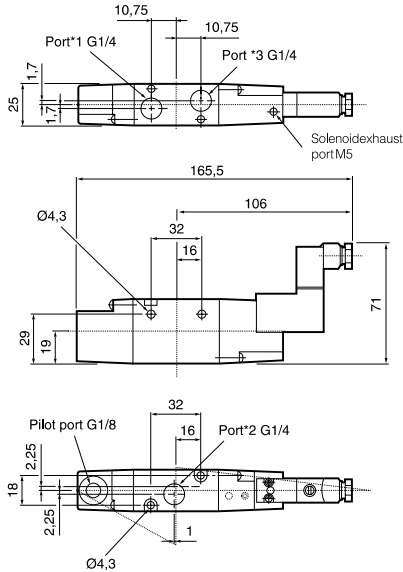

Single solenoid operated air pilot return

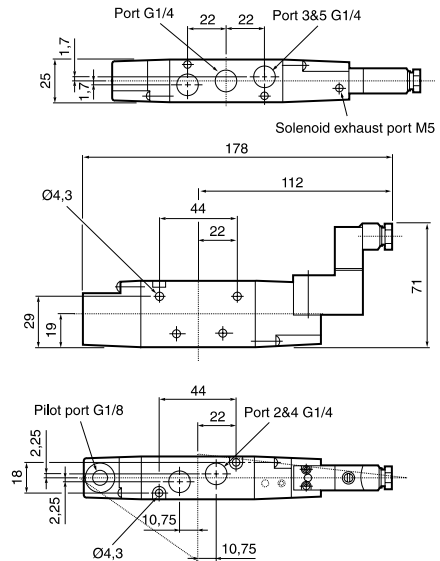

Double solenoid operated

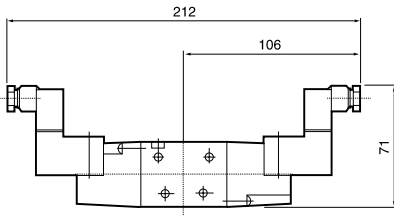

Double solenoid operated

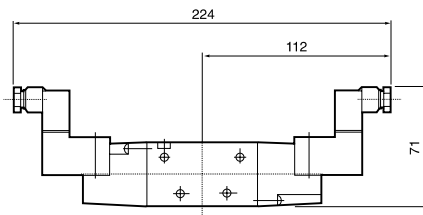

All dimensions in mm unless otherwise stated

Dimensions, B4 Valve Series

3/2 Body ported
Double air pilot operated

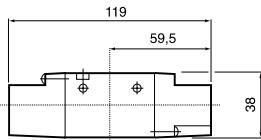

Air pilot operated air spring return / spring return
C

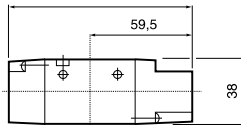

	Air differential return	Spring return
C	107,5	109,5

5/2 Body ported
Double air pilot operated

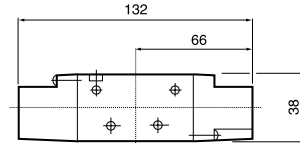

Air pilot operated air spring return / spring return
D

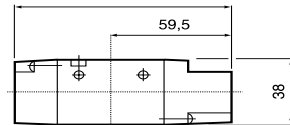

	Air differential return	Spring return
D	120,0	122,0

5/3 Body ported
Double air pilot return

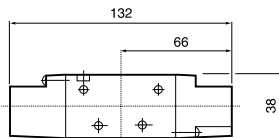

5/3 Body ported
Double solenoid operated

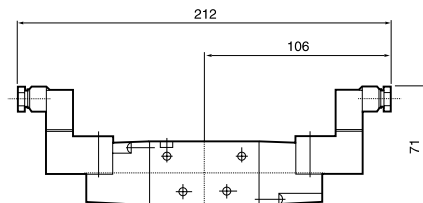

K

Manifolds - IEM Inlet Exhaust Manifold System

3/2 Inlet Exhaust Manifold
For B4 Body Ported Valves

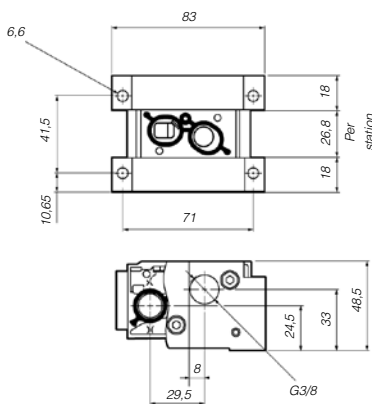

5/2 Inlet Exhaust Manifold
For B4 Body Ported Valves

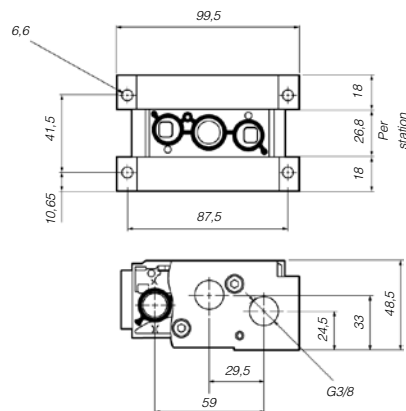

All dimensions in mm unless otherwise stated

- G1/4 ports, 3/2, 5/2 and 5/3 functions
- Inlet-exhaust manifold facility
- Integral mounting holes
- 5 watt solenoid actuators
- EN175301-803 Industrial Form B connector



Operating information

Working pressure	Max 10 bar	Flow (3/2) and (5/2) (acc. to ISO 6358)	Qn = 24 l/s Q max = 37 l/s Cv = 1,4
Working temperature; Pneumatically actuated	-10°C to +60°C		
Electrically actuated	-10°C to +50°C		

K

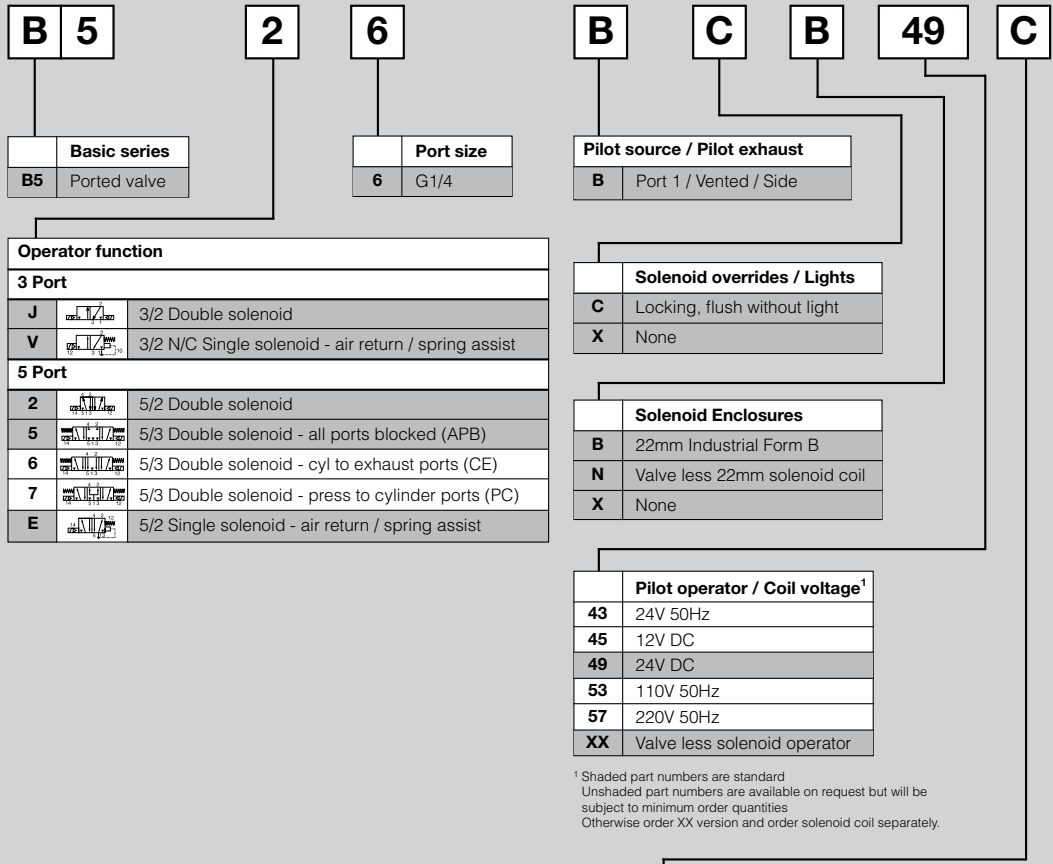







Shaded part numbers are standard

Engineering level C

¹ Shaded part numbers are standard
Unshaded part numbers are available on request but will be subject to minimum order quantities
Otherwise order XX version and order solenoid coil separately.

Main data for Directional control valves, B5 Series (G1/4 threaded ports)

Symbol	Actuator	Return	Signal pressure min, bar at 6 bar actua./return	Changeover time, ms at 6 bar actua./return	Weight Kg	Voltage	Order code	Qty
Electrically actuated 3/2 valves								
	Electric	Air/Spring Assisted	2,4/2,4	24/26		24 VDC Less solenoid coil	B5V6BCB49C B5V6BCNXXC	1 1
	Electric	Electric	1,5/1/5	15/17		24 VDC Less solenoid coil	B5J6BCB49C B5J6BCNXXC	1 1
Electrically actuated 5/2 valves								
	Electric	Air/Spring Assisted	2,4/2,4	24/26		24 VDC Less solenoid coil	B5E6BCB49C B5E6BCNXXC	1 1
Electrically actuated 5/2 valves								
	Electric	Electric	1,5/1,5	15/15	0,283 0,185	24 VDC Less solenoid	B526BCB49C B526BCNXXC	1 1
	Electric	Electric	3,0/3,0	16/18	0,289 0,191	24 VDC Less solenoid	B556BCB49C B556BCNXXC	1 1
	Electric	Electric	3,0/3,0	16/18	0,289 0,191	24 VDC Less solenoid	B566BCB49C B566BCNXXC	1 1
	Electric	Electric	3,0/3,0	16/18	0,289 0,191	24 VDC Less solenoid	B576BCB49C B576BCNXXC	1 1

Order solenoid connectors separately, see page 25 for part numbers.

Internal air supply to differential pilots and solenoids via port 1
Silencers and push-in fittings are shown on page 27.

K

Inlet Exhaust Manifolds for B5 series valves

Standard Base without Flow Controls

- Each kit contains:
 1 pcs Manifold Base
 2 pcs Mounting screws and nuts
 2 pcs Tie Rods
 1 pcs Body-to-base Gasket and
 1 pcs Base-to-Base Gasket

	Order code	Qty
Manifold Base Kit	PS2817P	1

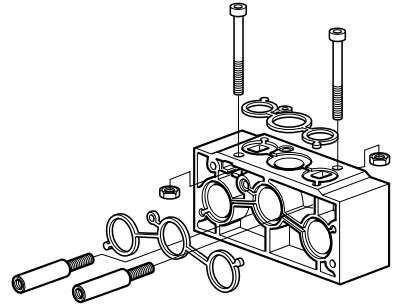

End plates

Standard End Plates may be used with either of above Manifold Bases

- Each kit contains:
 1 right and 1 left End Plate
 3 pcs O-Rings
 3 pcs Blanking Plugs
 2 pcs Socket Head Cap Screws
 2 pcs Flat Washers
 2 pcs Lockwashers

	Port Size	Order code	Qty
Manifold End plate kit	G3/8	PS2815P	1

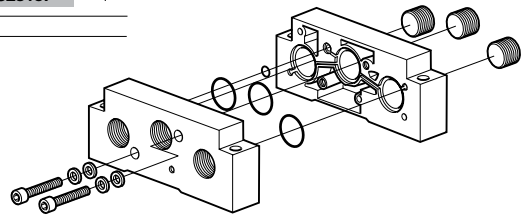

Isolator Plug Kit

Used to isolate the 1, 3 or 5 gallery between two Manifold Bases

- Each kit contains:
 3 pcs Isolator Plugs complete with O-rings

	Order code	Qty
Isolator Plug kit	PS2819P	1

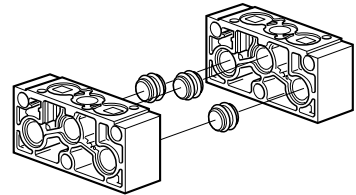

Manifold Blanking plate

- Each kit contains:
 1 pcs Cover Plate
 2 pcs Mounting Screws
 1 pcs Gasket
 Used to blank off unused stations.

	Order code	Qty
Manifold Blanking plate	PS2869P	1

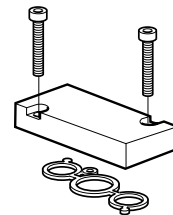

Dimensions, B5 Valve Series

3/2 Body ported

Single solenoid operated air spring return / spring return

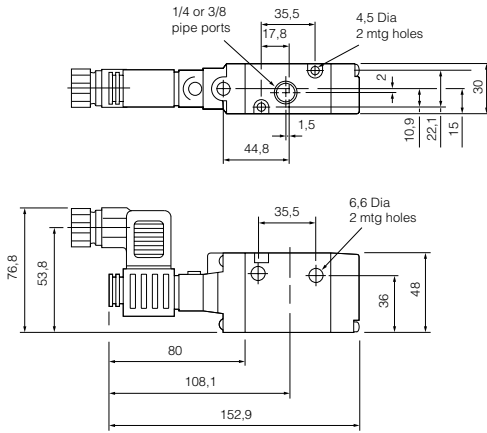

5/2 and 5/3 Body ported

Single solenoid operated air spring return / spring return

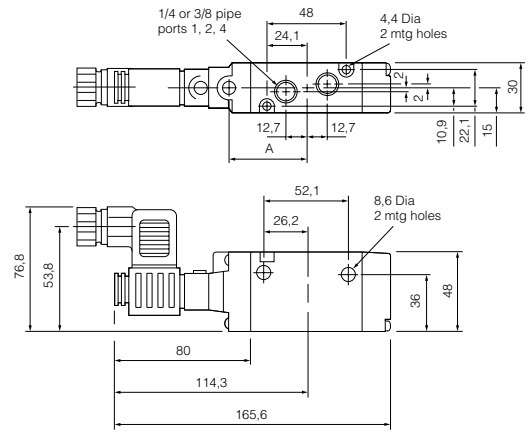

	2 Position	3 Position
A	51,1	62,7

Double solenoid operated

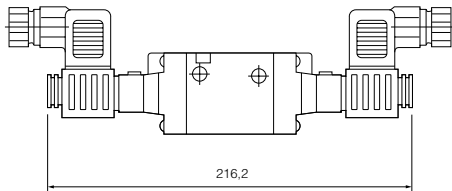

Double solenoid operated

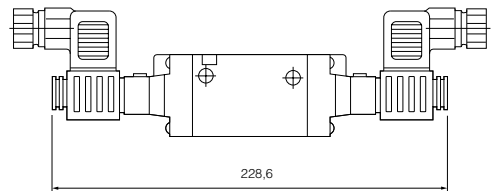

All dimensions in mm unless otherwise stated

Manifolds - IEM Inlet Exhaust Manifold System

5/2 Inlet Exhaust Manifold
For B5 Body Ported Valves

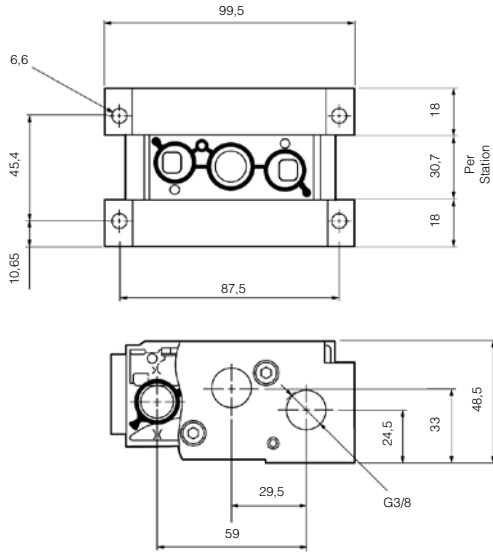

K

All dimensions in mm unless otherwise stated

Valve supplied without solenoids

B3 and B4 valves are designed to accept 15mm solenoid operator / connector CECC/EN 175301-803 Form C/ISO 15217. Solenoid operated valves may be ordered without the solenoid operator and connector by substituting XXXX in positions 6 to 9 of the part number. Example B3T5BXXXXH is part number for 5/2 Single solenoid operated spring return valve without solenoid operator and standard connector. See Fig 1.



Fig 1.

B5 valves are designed to accept 22mm solenoid operator/connector EN175301-803 Industrial Form B. Solenoid valves may be ordered without the coil and connector and are supplied with the solenoid operator fitted to the valve. See Fig 2.
Example B5E6BCNXXC is part number for 5/2 Single solenoid operated valve fitted with the solenoid operator having flush locking M/O without coils and connectors.

K



Fig 2.

15mm Solenoid Operators for B3 and B4 Valves

Electrical connection EN 175302-803 C/ISO15217 (Ex DIN 43650C)

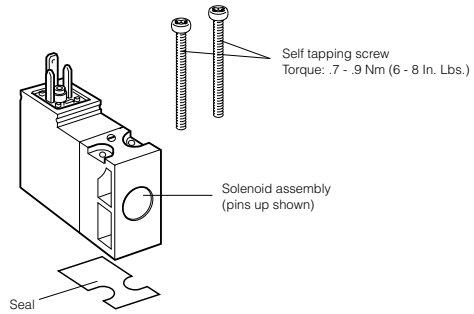

Solenoids 15mm NC, standard

(Note! Mounting screws included with basic valve)

	Voltage	Weight Kg	Order code Without manual override	Weight Kg	Order code Override, blue, non locking flush	Weight Kg	Order code Override, yellow, locking flush
	12 VDC	0,038	P2E-KV32B0	0,038	P2E-KV32B1	0,038	P2E-KV32B2
	24 VDC	0,038	P2E-KV32C0	0,038	P2E-KV32C1	0,038	P2E-KV32C2
	48 VDC	0,038	P2E-KV32D0	0,038	P2E-KV32D1	0,038	P2E-KV32D2
	24 VAC 50Hz	0,038	P2E-KV31C0	0,038	P2E-KV31C1	0,038	P2E-KV31C2
	48 VAC 50/60Hz	0,038	P2E-KV34D0	0,038	P2E-KV34D1	0,038	P2E-KV34D2
	115 VAC 50Hz	0,038	P2E-KV31F0	0,038	P2E-KV31F1	0,038	P2E-KV31F2
	120 VAC 60Hz						
	230 VAC 50Hz	0,038	P2E-KV31J0	0,038	P2E-KV31J1	0,038	P2E-KV31J2
	240 VAC 60Hz						

Solenoid coils for B5 valves

Solenoid coils to suit 'N' enclosure type 22mm 3-Pin EN 175301-803 Industrial Form B

Coil Voltage	Order code	Weight (kg)
24 VAC	P2FCB442	0.093
12 VDC	P2FCB445	0.093
24 VDC	P2FCB449	0.093
110 VAC	P2FCB453	0.093
230 VAC	P2FCB457	0.093

Solenoid Operator Kit for B5 valves

Each kit contains:
 1 large 'O' ring for operator base
 1 small 'O' ring for operator base
 2 mounting screws

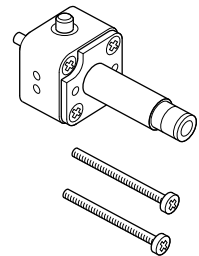

Spare solenoid nuts



Valves with vented exhaust are fitted with diffuser plastic nut

Order code
P2FND



	Order code	Weight (kg)	Qty
Non locking m/o	P2FP13N4D	0.04	1
Locking m/o	P2FP13N4C	0.04	1

Solenoid Connectors / Cable Plugs EN175301-803

	Description	Order code 15mm Form C/ISO15217 Suitable for B3 & B4 valves	Order code 22mm Industrial Form B Suitable for B5 valves
With large headed screw suitable for mounting in inaccessible or recess position 	Standard IP65	P8C-C	
	24V DC LED and protection IP65	P8C-C26C	
	110V AC LED and protection IP65	P8C-C21E	
With standard screw 	Standard IP65 without flying lead	P8C-D	3EV10V10
	With LED and protection 24V AC/DC	P8C-D26C	3EV10V20-24
	With LED and protection 110V AC	P8C-D21E	3EV10V20-110
	With LED and protection 230V AC		3EV10V20-230
With cable 	Standard with 2m cable IP65	P8L-C2	
	Standard with 5m cable IP65	P8L-C5	
	24V AC/DC, 2m cable LED and protection IP65	P8L-C226C	
	24V AC/DC, 5m cable LED and protection IP65	P8L-C526C	3EV10V20-24L5
	24V AC/DC, 10m cable LED and protection IP65	P8L-CA26C	
	110V AC/DC, 2m cable LED and protection IP65	P8L-C221E	
	110V AC/DC, 5m cable LED and protection IP65	P8L-C521E	3EV10V20-110L5
	230V AC, 5m cable LED and protection IP65		3EV10V20-230L5

K

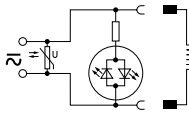
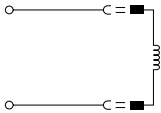

P8C-C
P8C-D
P8L-C2
P8L-C5
3EV10V10
3EV290V10

P8C-D26C	P8L-C226C
P8C-D21E	P8L-C526C
P8C-C26C	P8L-CA26C
P8C-C21E	P8L-C221E
	P8L-C521E
3EV10V20-24	3EV10V20-24L5
3EV10V20-110	3EV10V20-110L5
3EV10V20-230	3EV10V20-230L5

Cable Plug Dimensions (mm)

Solenoid valves P2E-•V...

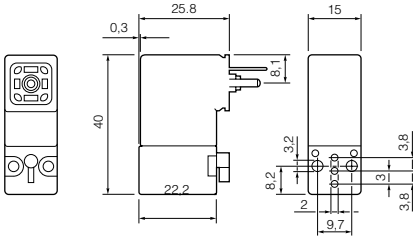

Cable plugs form C / ISO 15217 for B3 & B4 valves

- P8C-C
- P8C-C26C
- P8C-C21E
- P8C-D
- P8C-D26C
- P8C-D21E

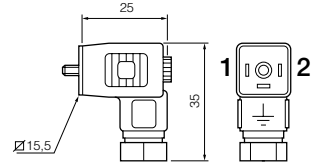

Cable plugs form C / ISO 15217 with cables for B3 & B4 valves

- P8L-C2
- P8LC5
- P8L-C226C
- P8L-C526C
- P8L-CA26C
- P8L-C221E
- P8L-C521E

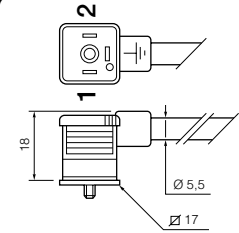

Cable plugs Form B for B5 valves

- 3EV10V10

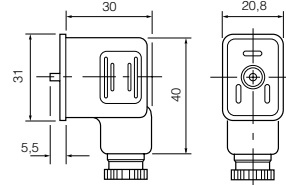

K

Accessories, Service and Replacement Parts

Silencers

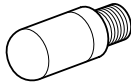

Port	Ordercode	Pack Qty
M5	P6M-PAC5	10
G1/8	P6M-PAB1	10
G1/4	P6M-PAB2	10

Fittings

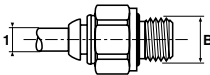

Male straight connectors - Parallel thread

Tube dia 1	Thread B	Ordercode	Box Qty
4	M5 x 0.8	F8PMB4M5	30
6	M5 x 0.8	F8PMB6M5	20
4	G1/8	F4PMB4-1/8	20
6	G1/8	F4PMB6-1/8	30
8	G1/8	F4PMB8-1/8	40
6	G1/4	F4PMB6-1/4	30
8	G1/4	F4PB8-1/4	30
10	G1/4	F4PB10-1/4	20
12	G1/4	F4PB12-1/4	10

B3,B4 and B5 Spool/Body repair kits contain:

- Spool
- Spool seals
- Lip seal – operator pistons
- Gaskets
- Spool springs
- Grease packet

B3 series valves

3/2 solenoid and remote air pilot operated valves -Spool/Body Repair kit	PS2971F
5/2 solenoid and remote air pilot operated valves -Spool/Body Repair kit	PS2901F
5/3 APB solenoid and remote pilot operated valves - Spool/Body Repair kit	PS2902F

Manifold gasket kits

3/2 IEM Gasket kit (10 valve/manifold gaskets)	PS2980F
5/2 IEM Gasket kit (10 valve/manifold gaskets)	PS2981F

B4 series valves

3/2 solenoid and remote air pilot operated valves - Spool/Body Repair kit	PS4571F
5/2 solenoid and remote air pilot operated valves - Spool/Body Repair kit	PS4501F
5/3 solenoid and remote pilot operated valves – APB Spool/Body Repair kit	PS4502F
5/3 solenoid and remote pilot operated valves – CE Spool/Body repair kit	PS4503F
5/3 solenoid and remote pilot operated valves – PC Spool/Body repair kit	PS4504F

Manifold gasket Kits.

3/2 IEM Gasket Kit (10 valve/manifold gaskets)	PS4580F
5/2 IEM Gasket Kit (10 valve/manifold gaskets)	PS4581F

B5 series valves

3/2 solenoid and remote air pilot operated valves - Spool/Body Repair kit	PS2871P
5/2 solenoid and remote air pilot operated valves - Spool/Body Repair kit	PS2801P
5/3 solenoid and remote pilot operated valves – APB Spool/Body Repair kit	PS2802P
5/3 solenoid and remote pilot operated valves – CE Spool/Body repair kit	PS 2803P
5/3 solenoid and remote pilot operated valves – PC Spool/Body repair kit	PS2804P

Manifold gasket Kits.

3/2 & 5/2 IEM Gasket kit PS2884P (10 valve/manifold gaskets)	PS2884P
--	----------------

Solenoid coils for B5 valves

Solenoid coils to suit 'N' enclosure type 22mm 3-Pin Industrial Form B

Coil Voltage	Order code	Weight (kg)
24VAC	P2FCB442	0.093
12VDC	P2FCB445	0.093
24VDC	P2FCB449	0.093
110VAC	P2FCB453	0.093
230VAC	P2FCB457	0.093

Solenoid operator kit

Each kit contains:

- 1 Large 'O' ring for operator base
- 1 Small 'O' ring for operator base

	Order code	Qty
Non locking m/o	P2FP13N4D	1
Locking m/o	P2FP13N4C	1

K



Midget & Intermediate Manual & Mechanical Valves

G1/8 - G1/4 body ported

Midget / Intermediate G1/8 & G1/4 Control Valves

The compact design of these valves make them a popular choice for manual or mechanical operation and their modular construction permit different operators to be fitted to the actuator and return assemblies.

Wide application range

The Midget and Intermediate valves are designed to have balanced forces across the spool so that 3/2 valves can be piped normally open or normally closed by changing the inlet supply from port 1 to port 3. Because forces across the spool are balanced 5/2 valves can also be piped in different ways to suit applications which require different pressures through the same valve. For example when a cylinder needs to advance with low force (pressure) to avoid bruising a component and retracts with normal pressure.

Fast operating speeds

The G1/8 Midget valve has a short travel and lightweight spool so that high operating speeds are possible. These valves have been tested at over 3000 cycles per minute.

Working medium, air quality

Working medium: Dry, filtered compressed air to ISO 8573-1 class 3.4.3.

Recommended air quality for valves

For best possible service life and trouble free operation, ISO 8573-1 quality class 3.4.3 should be used. This means 5µm filter (standard filter) dew point +3°C for indoor operation (a lower dew point should be selected for outdoor operation) and oil concentration 1.0 mg oil/m³, which is what a standard compressor with a standard filter gives.

High reliability

Valves easily comply with the requirements for the EU Machinery Directive standards EN292-2 and EN983. The bodies of the Midget and Intermediate valves are manufactured from aluminium with stainless steel spool, sealed by static viton 'O' rings. All operating parts exposed to the working fluid are of non-corrosive material and all ports threaded G1/8 or G1/4. The valves are designed to give long trouble free service life when used with or without lubrication.

Modular construction

The modular construction of the valves allows any of the actuators to be spring return or air pilot return. Roller versions are designed to give a common height on both 3/2 and 5/2 valves to ensure uniformity and efficiency in a multi-valve assembly.

Maintenance

These valves can be serviced without disturbing the pipe-work simply by unscrewing the actuator and return assemblies and then removing the spool and 'O' ring assembly.

ISO 8573-1 quality classes

Quality class	Pollution		Water max. press. dew point (°C)	Oil max. concentration (mg/m ³)
	particle size (µm)	max. concentration (mg/m ³)		
1	0,1	0,1	-70	0,01
2	1	1	-40	0,1
3	5	5	-20	1,0
4	15	8	+3	5,0
5	40	10	+7	25
6	-	-	+10	-

Material specification

Valve body	Aluminium
Spool	Stainless steel
Seal spacers	Zinc die cast
Seals	Viton
Spring housing	Nylon
Spring	Zinc plated
End covers	Zinc die cast
Actuators	Zinc die cast
End cover screws	Zinc plated

Technical information

Type	Spool valves
Style	Body ported
Port size	G1/8 & G1/4
Mounting	Any plane
Pressure range	Vacuum to 10 bar
Temperature range	-10°C to +80°C
Flow acc. (to ISO 6358)	

Midget B43 series Intermediate B53 series

$c = 1.13 \text{ NI/s} \times \text{bar}$	$c = 3.69 \text{ NI/s} \times \text{bar}$
$b = 0.36$	$b = 0.33$
$Q_n = 5.5 \text{ l/s}$	$Q_n = 17.5 \text{ l/s}$
$Q_{max} = 9.0 \text{ l/s}$	$Q_{max} = 29 \text{ l/s}$
$C_v = 0.24$	$C_v = 1.02$

Flow characteristics

Flow capacities in accordance with ISO 6358
 The flow curves shown below are typical.

Midget B43 series valves

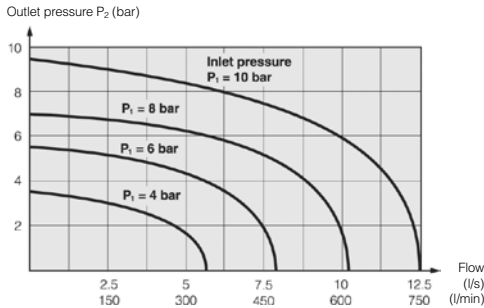

Intermediate B53 series valves

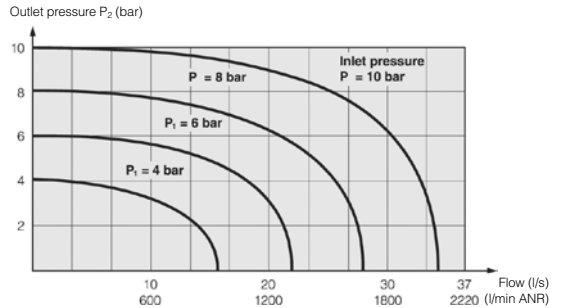















Midget mechanically operated valves, B43 series

	Symbol	Type	Actuator	Return	Operating force at 6 bar, N	Size	Weight Kg	Order code
		3/2	Plunger	Spring	36	G1/8	0,182	B43003CS
		3/2	Plunger	Air	14	G1/8	0,202	B43003CP
		5/2	Plunger	Spring	36	G1/8	0,222	B43004CS
		5/2	Plunger	Air	14	G1/8	0,242	B43004CP
		3/2	Roller Lever	Spring	20	G1/8	0,234	B43003RS
		3/2	Roller lever	Air	7	G1/8	0,254	B43003RP
		5/2	Roller Lever	Spring	20	G1/8	0,274	B43004RS
		5/2	Roller lever	Air	7	G1/8	0,294	B43004RP
		3/2	One way roller lever	Spring	20	G1/8	0,274	B43003RTS
		3/2	One way roller lever	Air	7	G1/8	0,294	B43003RTP
		5/2	One way roller lever	Spring	20	G1/8	0,314	B43004RTS
		5/2	One way roller lever	Air	7	G1/8	0,334	B43004RTP

Indicates stocked product.













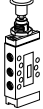



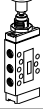

Intermediate mechanically operated valves, B53 series

	Symbol	Type	Actuator	Return	Operating force at 6 bar, N	Size	Weight Kg	Order code
		3/2	Plunger	Spring	53	G1/4	0,348	B53003CS
		3/2	Plunger	Air	27	G1/4	0,388	B53003CP
		5/2	Plunger	Spring	53	G1/4	0,478	B53004CS
		5/2	Plunger	Air	27	G1/4	0,518	B53004CP
		3/2	Roller	Spring	53	G1/4	0,350	B53003RS
		3/2	Roller	Air	27	G1/4	0,390	B53003RP
		5/2	Roller	Spring	53	G1/4	0,480	B53004RS
		5/2	Roller	Air	27	G1/4	0,520	B53004RP

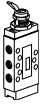
L

 Indicates stocked product.

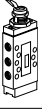
Midget manually operated valves, B43 series

	Symbol	Type	Actuator	Return	Operating force at 6 bar, N	Size	Weight Kg	Order code
		3/2	Button, black	Spring	36	G1/8	0,200	B43003BXS
		3/2	Button, black	Button	13	G1/8	0,200	B43003HXS
		5/2	Button, black	Spring	36	G1/8	0,240	B43004BXS
		5/2	Button, black	Button	13	G1/8	0,240	B43004HXS
		3/2	Button, black	Air	13	G1/8	0,200	B43003BXP
		3/2	Button, black	Air or button	13	G1/8	0,200	B43003HXP
		5/2	Button, black	Air	13	G1/8	0,240	B43004BXP
		5/2	Button, black	Air or button	13	G1/8	0,280	B43004XHP
		3/2	Lock down lever	Spring	9	G1/8	0,202	B43003LS
		3/2	Lock down lever	Spring	9	G1/8	0,242	B43004LS
		3/2	Lock down lever	Air	3	G1/8	0,240	B43003LP
		3/2	Lock down lever	Air	3	G1/8	0,280	B43004LP





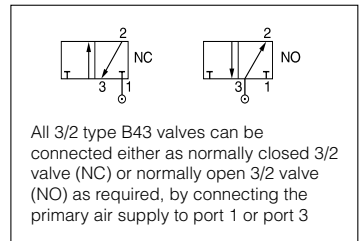







Note: The standard button colour is black (X)
 For optional colour buttons change 8th character of order code
 e.g. B43004HXS = Black button, B43004HZS = Green button,
 B43004HYS = Red button.

- X = Black
- Z = Green
- Y = Red



 Indicates stocked product.

Intermediate manually operated valves, B53 series

	Symbol	Type	Actuator	Return	Operating force at 6 bar, N	Size	Weight Kg	Order code
		3/2	Button, black	Spring	53	G1/4	0,368	B53003HXS
		3/2	Button, black	Button	27	G1/4	0,368	B53003HX
		3/2	Button, black	Air	27	G1/4	0,380	B53003HXP
		5/2	Button, black	Spring	53	G1/4	0,498	B53004HXS
		5/2	Button, black	Button	27	G1/4	0,498	B53004HX
		5/2	Button, black	Air	27	G1/4	0,510	B53004HXP
		5/3	Button Closed centre position	Button Self centring	53	G1/4	0,623	B53004HXX
		5/3	Button Vented centre position	Button Self centring	53	G1/4	0,623	B53004HXY
		5/3	Button Pressurised centre position	Button Self centring	53	G1/4	0,623	B53004HXZ

Note: The standard button colour is black (X)

For optional colour buttons change 8th character of order code e.g. B43004HXS = Black button, B43004HXS = Green button, B43004HYS = Red button.

X = Black

Z = Green















Y = Red



All 3/2 type B43 valves can be connected either as normally closed 3/2 valve (NC) or normally open 3/2 valve (NO) as required, by connecting the primary air supply to port 1 or port 3

 Indicates stocked product.

Intermediate lever operated valves, B53 series

Symbol	Type	Actuator	Return	Operating force at 6 bar, N	Size	Weight Kg	Order code
	3/2	Lever	Spring	14	G1/4	0,504	B53003LS
	3/2	Lever	Air	9	G1/4	0,520	B53003LP
	3/2	Lever	Lever	9	G1/4	0,500	B53003LT
	3/3	Lever Closed centre position	Lever	9	G1/4	0,504	B53003L
	3/3	Lever Closed centre position	Lever Self centring	14	G1/4	0,780	B53003LX
	5/2	Lever	Spring	14	G1/4	0,506	B53004LS
	5/2	Lever	Air	14	G1/4	0,526	B53004LP
	5/2	Lever	Lever	14	G1/4	0,632	B53004LT
	5/3	Lever Closed centre position	Lever held in three positions	9	G1/4	0,640	B53004L
	5/3	Lever Vented centre position	Lever held in three positions	9	G1/4	0,640	B53004LW
	5/3	Lever Pressurised centre position	Lever held in three positions	9	G1/4	0,640	B53004LN
	5/3	Lever Closed centre position	Lever Self centring	14	G1/4	0,780	B53004LX
	5/3	Lever Vented centre position	Lever Self centring	14	G1/4	0,780	B53004LY
	5/3	Lever Pressurised centre position	Lever Self centring	14	G1/4	0,780	B53004LZ

Mounting kit

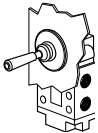

Panel mounting kit



0,040

M53004L-10A



Kit includes panel plate and M5 counter sunk head screws

 Indicates stocked product.





Midget foot operated valves, B43 series

Symbol	Type	Actuator	Return	Operating force at 6 bar, N	Size	Weight Kg	Order code
	3/2	Foot pedal	Spring	16	G1/8	0,312	B43003FS
	5/2	Foot pedal	Spring	16	G1/8	0,370	B43004FS

Intermediate foot operated valves, B53 series



Symbol	Type	Actuator	Return	Operating force at 6 bar, N	Size	Weight Kg	Order code
Single pedal operated							
	3/2	Foot pedal	Spring	95	G1/4	1,34	B53003FS
	5/2	Foot pedal	Spring	95	G1/4	1,48	B53004FS

Rocker pedal operated

	3/2	Foot pedal	Foot pedal	18	G1/4	1,38	B53003G
	5/2	Foot pedal	Foot pedal	18	G1/4	1,58	B53004G
	5/3	Foot pedal Closed centre position	Foot pedal Self centring	18	G1/4	1,68	B53004GX
	5/3	Foot pedal Vented centre position	Foot pedal Self centring	18	G1/4	1,68	B53004GY
	5/3	Foot pedal Pressurised centre position	Foot pedal Self centring	18	G1/4	1,68	B53004GZ

Accessories

	Foot guard kit					1,16	3117
---	----------------	--	--	--	--	------	-------------

All 3/2 type B43 and B5/3 valves can be connected either as normally closed 3/2 valve (NC) or normally open 3/2 valve (NO) as required, by connecting the primary air supply to port 1 or port 3

 Indicates stocked product.

Dimensions, G1/8 ported spool valves

All dimensions in mm unless otherwise stated

Mechanically operated valves

3/2 valves

Plunger operated spring return

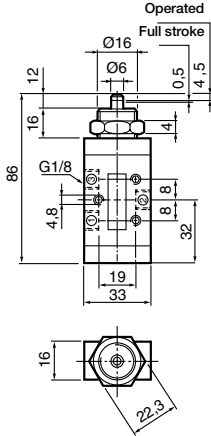

5/2 valves

Plunger operated spring return

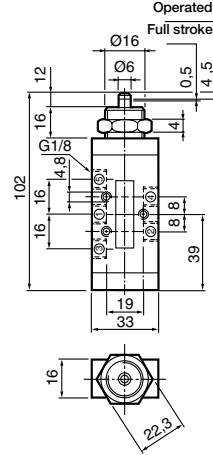

3/2 valves

Roller operated spring return

One way roller trip operate spring return

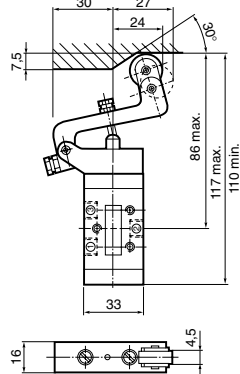
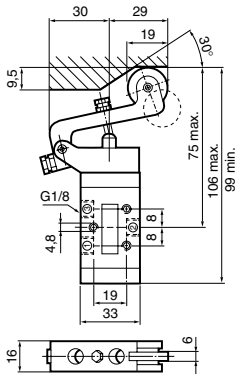

5/2 valves

Roller operated spring return

One way roller trip operate spring return

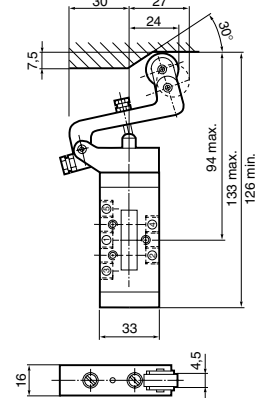
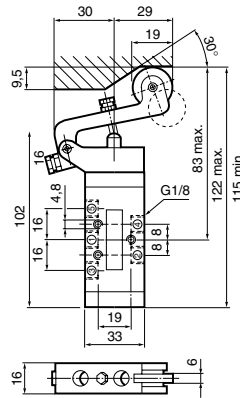

Air Pilot Return

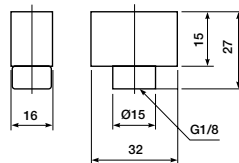

Optional foot mounted - Spring return housing

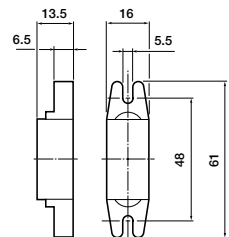

Dimensions, G1/8 ported spool valves

All dimensions in mm unless otherwise stated

Manually operated valves

3/2 valves

Button operated spring return
 or button returned

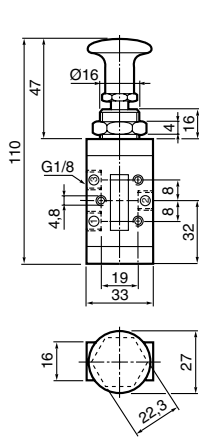

Lock down lever
 operated spring return

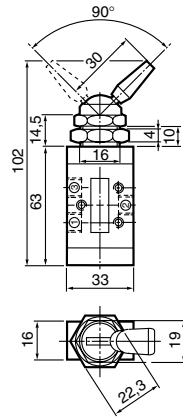

5/2 valves

Button operated spring return
 or button returned

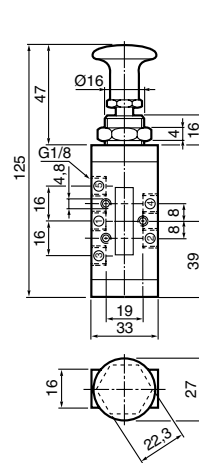

Lock down lever
 operated spring return

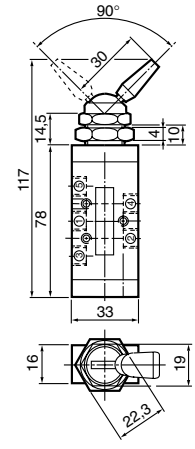

3/2 valves

Foot pedal operated spring return

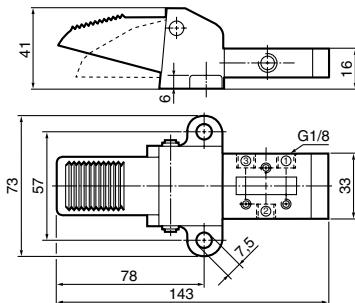

5/2 valves

Foot pedal operated spring return

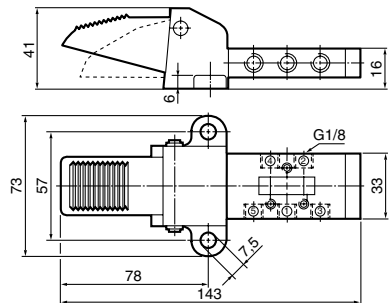

Air Pilot Return

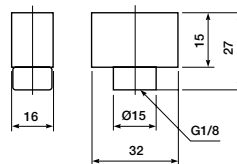

Optional foot mounted -
 Spring return housing

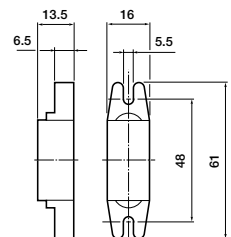

L

Dimensions, G1/4 ported spool valves

All dimensions in mm unless otherwise stated

Mechanically operated valves

3/2 valves

Plunger operated spring return

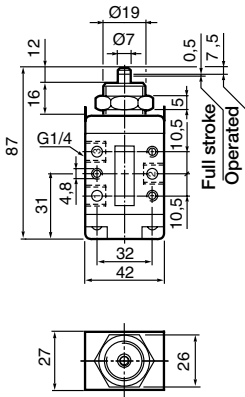

5/2 valves

Plunger operated spring return

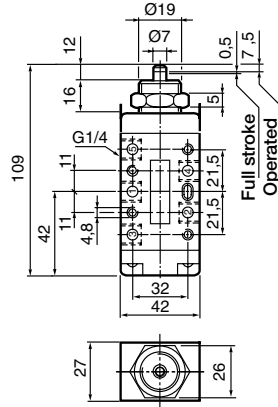

3/2 valves

Roller operated spring return

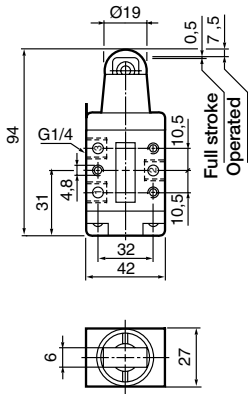

5/2 valves

Roller operated spring return

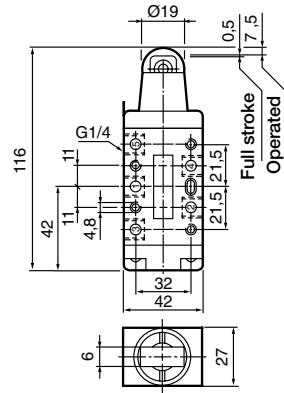

Air Pilot Return

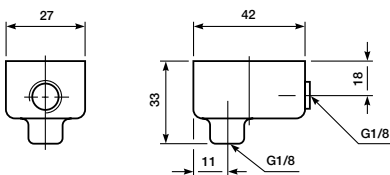

Dimensions, G1/4 ported spool valves

All dimensions in mm unless otherwise stated

Manually operated valves

3/2 valves

Button operated spring return
 or button returned

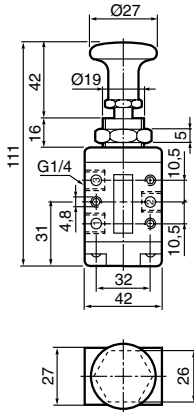

5/2 valves

Button operated spring return
 or button returned

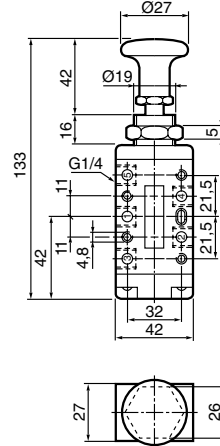

3/2 valves

Lever operated

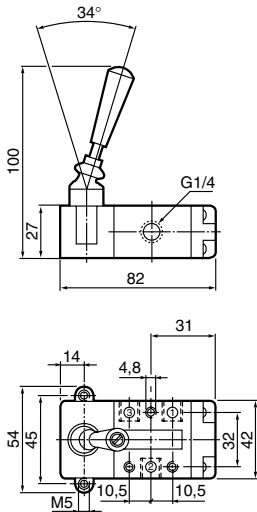

5/2 valves

Lever operated

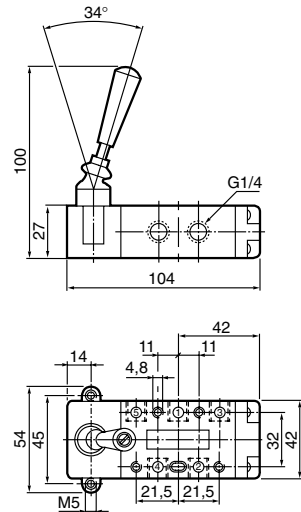

Air Pilot Return

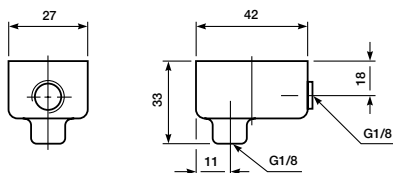

Dimensions, G1/4 ported spool valves

All dimensions in mm unless otherwise stated

Manually operated valves

3/3 valves (Self centring)

Lever operated

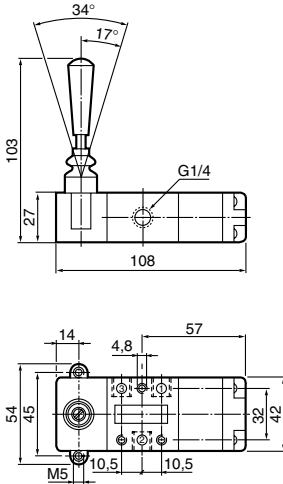

5/3 valves (Self centring)

Lever operated

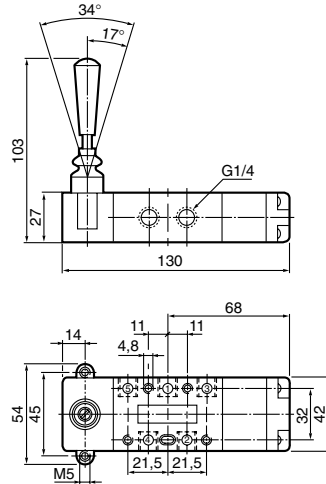

3/3 valves (3 positions)

Lever operated

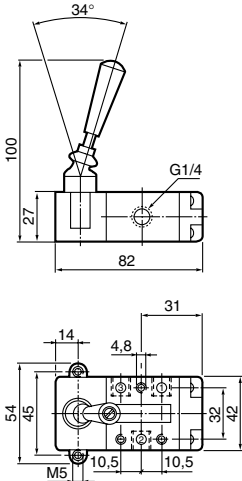

5/3 valves (3 positions)

Lever operated

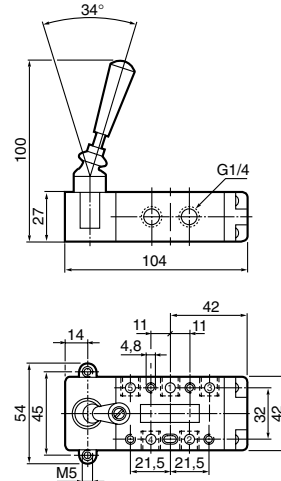

Air Pilot Return

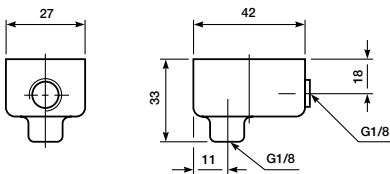

Dimensions, G1/4 ported spool valves

All dimensions in mm unless otherwise stated

Manually operated valves

3/2 valves

Foot pedal operated spring return

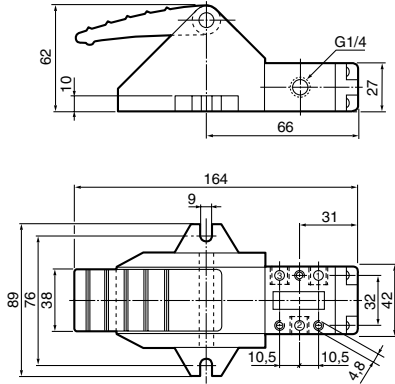

5/2 valves

Foot pedal operated spring return

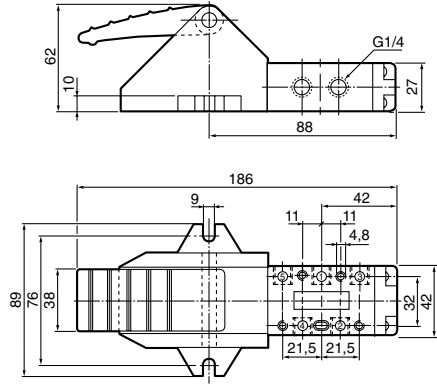

3/2 valves

Foot pedal operated

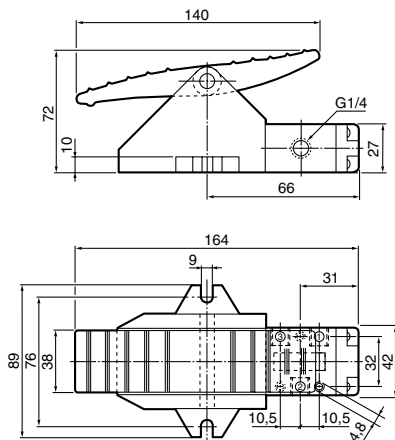

5/2 valves

Foot pedal operated

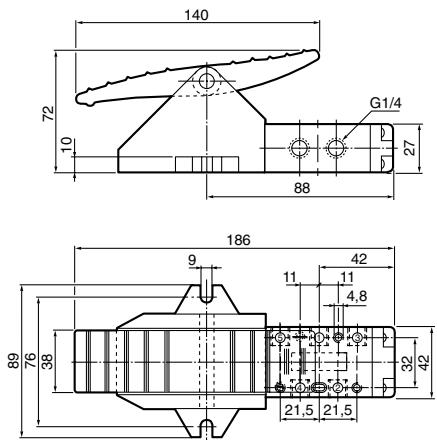

Dimensions, G1/4 ported spool valves

All dimensions in mm unless otherwise stated

Manually operated valves

5/3 valves

Foot pedal operated

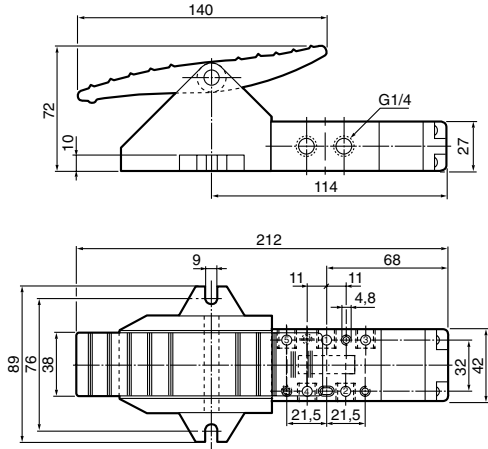

Foot guard kit

3117

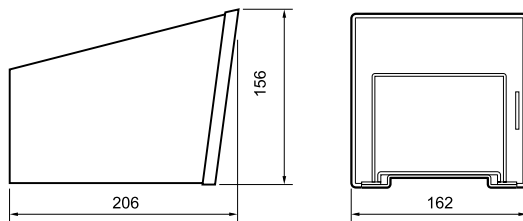

Service and Replacement Parts

B43 Series Manually Operated Valves

Order code	Actuator	Replacement actuator	Repair kit
B43003BXS	Button	43004BX-100	Body seal 43007A
B43004BXS	Button		
B43004HXS	Button, Push/Pull	43004H-100	
B43003LS	Lockdown lever	43004L-200	
B43004LS	Lockdown lever		

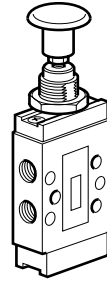

B53 Series Manually Operated Valves

Order code	Actuator	Replacement actuator	Repair kit
B53003HXS	Button		
B53004HXS	Button		
B53003HX	Button, Push/Pull		
B53004HX	Button, Push/Pull	53004HX-100	Body seal 53007
B53004HXX	Button, Self centring		
B53004HXY	Button, Self centring		
B53004HXZ	Button, Self centring		
B53003FS	Foot	53004F-100	
B53004FS	Foot		
B53003LS	Lever	53004L-198	
B53004LS	Lever		
B53003LT	Lever, 2 positions	53004L-196	Body seal 53007
B53004LT	Lever, 2 positions		
B53004L	Lever, 3 positions	53004L-100	Lever kit 53004L-300R
B53004LW	Lever, 3 positions		
B53004LX	Lever, Self centring	53004L-198	
B53004LY	Lever, Self centring		

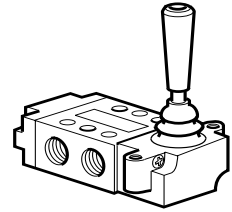

B43 Series Mechanically Operated Valves

Order code	Actuator	Replacement actuator	Repair kit
B43003CS	Plunger	43004C-100	
B43004CS	Plunger		Body seal 43007A
B43003RS	Roller Lever	43004R-200	
B43004RS	Roller Lever		

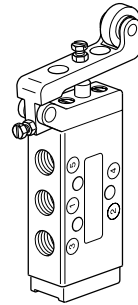

B53 Series Mechanically Operated Valves

Order code	Actuator	Replacement actuator	Repair kit
B53003CS	Plunger	53004C-100	
B53004CS	Plunger		
B53003RS	Roller	53004R-100	Body seal 53007
B53004RS	Roller		

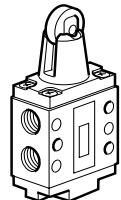

L

■ Indicates stocked product.

Lubricating Oils

To ensure long life and trouble free service from valves, it is recommended the equipment should be adequately lubricated by means of lubricators which disperse oil into the system. Only paraffinic based oils can be used, and the following recommendations are given as a general guide to types of oil that are suitable for use with Parker Pneumatic equipment.

The list opposite does not preclude the use of oils manufactured by other companies but oils must be paraffinic based.

As a general guide, lubricator drip rates should be 1 drip/minute for every 5 litre/second (10 cubic feet per minute) passed through the equipment.

Oil company	Grade	Viscosity
Century oils	P.W.L.A	32
Alexander Duckham	Zircon 4	32
Gulf oil (GB) Limited	Harmony 43 AW	32
Shell (UK) oil	Tellus 37	37
Burmah Castrol	Hyspin AWS 32	32
Edgar Vaughan	Y Hydrodrive HP 100	32
Esso Petroleum	Nuto H32	32
B.P.	HLP 32	32
Mobile Oil Company	DTE Oil - Light	32
Motul	VPI-A	32
Silkolene	Derwent 32	32

Accessories

Sintered bronze series

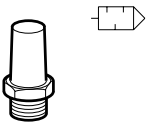

Port	Order code	Pack Qty
G1/8	9090050700	1
G1/4	P6M-BAA2	1

Male straight connectors - Parallel thread

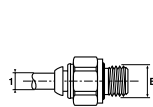

Tube Ø1	Thread B	Order code	Box Qty
4	1/8	F4PMB4-1/8	20
6	1/8	F4PMB6-1/8	30
6	1/4	F4PMB6-1/4	30
8	1/8	F4PB8-1/8	40
8	1/4	F4PB8-1/4	30
8	3/8	F4PB8-3/8	20
10	1/4	F4PB10-1/4	20

 Indicates stocked product.

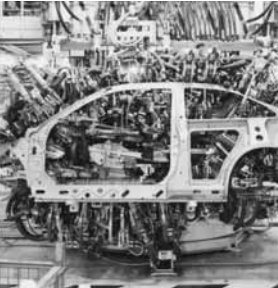

Directional Control Valves

Series VA13 and VA15
3 and 5 port valves. G1/8

Working medium, air quality

Working medium: Dry, filtered compressed air to ISO 8573-1 class 3.4.3.

Recommended air quality

For best possible service life and trouble free operation, ISO 8573-1 quality class 3.4.3 should be used. This means 5µm filter (standard filter) dew point +3°C for indoor operation (a lower dew point should be selected for outdoor operation) and oil concentration 1.0 mg oil/m³, which is what a standard compressor with a standard filter gives.

Compact installation dimensions - flexible installation

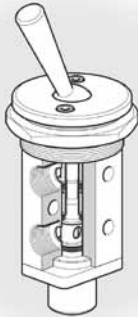

The VA13/15 valve range consists of spool valves of extremely robust design, incorporating a wide range of manual, mechanical and pilot-operated actuators.

Rust and corrosion resistant designs.

The valve bodies and caps are made of brass. Stainless steel is used in the spools and the mechanical actuating devices. Versions intended for panel mounting have chromium-plated steel actuators and panel bezels.

Mobile applications



The robust design, coupled with good corrosion resistance, makes the valves suitable for a wide range of applications. Manually operated valves are suitable for industrial and transport applications. The stable and ergonomically designed actuators make the valves easy to operate even with heavy working gloves.

ISO 8573-1 quality classes

Quality class	Pollution		Water max. press. dew point (°C)	Oil max. concentration (mg/m ³)
	particle size (µm)	max. concentration (mg/m ³)		
1	0,1	0,1	-70	0,01
2	1	1	-40	0,1
3	5	5	-20	1,0
4	15	8	+3	5,0
5	40	10	+7	25
6	-	-	+10	-

High reliability

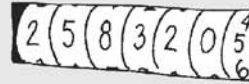

Valves easily comply with the requirements for component reliability in accordance with EU Machinery Directive standards EN292-2 and EN983.

The VA valves have few moving parts combined with short spool movement, these features combine to give valves having high reliability and long service life. The valves are designed for use with or without supplementary lubrication.

Maintenance

When maintenance is required repair kits containing replacement seals are available.

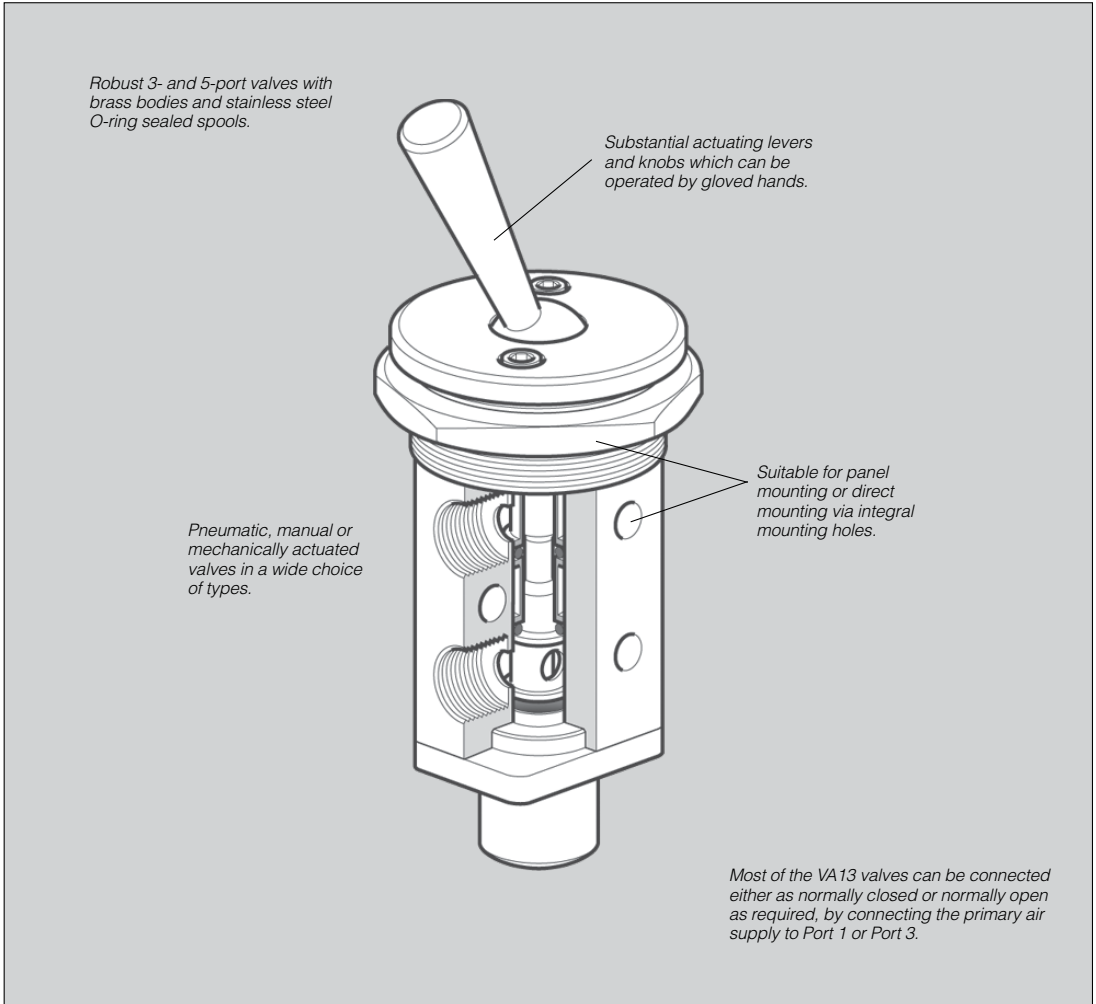

M

Ordering example **VA13-HIS4**

Valve type, VA _____

Valve size 1 = G1/8 _____

Number of ports, 3 or 5 _____

Type of actuation _____

Type of return _____

Type of installation _____

4 = panel mounted _____



Products specially suitable for the transport industry.

Installation

Correctly mounted valves require only a minimum of maintenance. For maximum life, follow the instructions with regard to actuation directions, actuation speeds, angles and adjustments.

Panel mounting

Mount the valves in a 40,5 mm diameter hole (thread M40 x 1,5). The panel-mounting collars have a flange on the front of the panel and a retaining nut behind the panel, for simple installation and clean and attractive appearance.

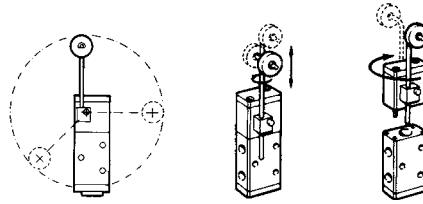

Fitting adjustable roller actuators

The rest position of the actuating arm can be arranged at any required angle on the actuator shaft (360°).

The length of the arm is adjustable, and it can also be rotated through 180°. Note, however, that the roller must always be parallel to the valve body.

The arm can also be positioned on the other side of the valve by removing the actuating mechanism, turning it through 180° and reassembling it.

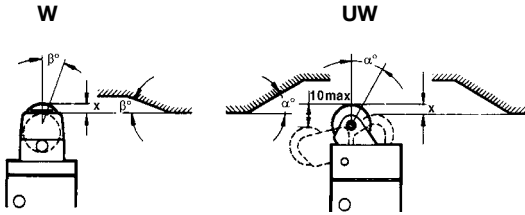

Actuation

Maximum actuation distance (X), i.e. the maximum spool stroke length, is 4 mm. Valves are fully open after 3,5 mm travel. Type UW toggle cam actuators permit a vertical motion in toggle direction of up to 10 mm.

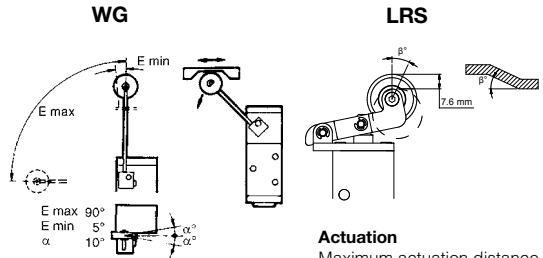

Actuation
Maximum actuation distance, the maximum spool stroke length is 7.6 mm.

Actuation by adjustable roller

Actuation can be arranged in both directions if the arm is set as shown above. The arm needs to be moved through only 5° to make the valve change over, although a travel range of up to 90° can be accepted.

Material specifications

Valve bodies, end covers,	Brass
spring guides	Polished stainless steel
Spools	Nitrile rubber
Seals	Zinc plated steel
Screws, nuts, washers	Steel
Balls	Acetal plastic
Push-buttons, knobs	Chrome-plated steel
Lever	Phosphatized cast-iron
Pedals	Hardened stainless steel
I-plunger	Acetal plastic
Rollers	

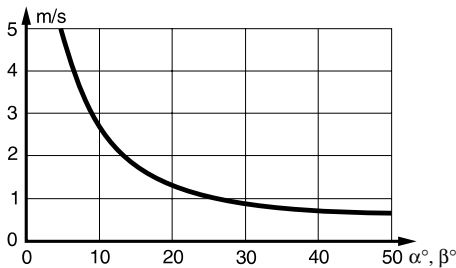

Actuation speed as a function of actuation angle



Optimum valve life will be obtained if the shape of actuation cams is matched to the method of actuation employed. The principle is that the higher the speed of the actuating motion, the smaller the incident angle. The characteristic curve shown here plots the incident angle against speed of the actuating stroke.



IMPORTANT
Before servicing, make sure that the valve is depressurised. Disconnect the primary air hose to ensure that the air supply is safely interrupted before removing valves.

Data

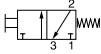
Working temperature:	-20 °C to +70 °C
Working pressure:	max 10 bar
Flow (acc. to ISO 6358)	
C:	0,9 NI/s, bar
Qn (P1=6 bar, Δp=1 bar):	3,6 l/s
Qmax:	6,3 l/s
Cv:	0,21

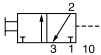
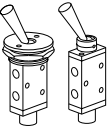
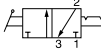
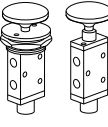
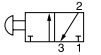
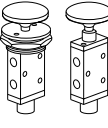
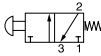
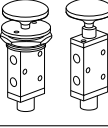
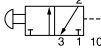
Symbol	Actuator	Return	Mounting	Changeover force at 6 bar	Weight kg	Order code
 	Push-button Red	Spring	Panel mounted	32,5 N	0,37	VA13-HIS4
	Push-button Black	Spring	Panel mounted	32,5 N	0,37	VA13-HIS4A06*
 	Push-button Red	Air signal	Panel mounted	6 N**	0,37	VA13-HIA4
 	Hand lever Held in two positions	Hand lever	Panel mounted	8 N	0,52	VA13-HB24
			Side mounted	8 N	0,35	VA13-HB2
 	Knob Red Two positions	Knob	Panel mounted	3 N	0,48	VA13-KL24
			Side mounted	3 N	0,31	VA13-KL2
 	Knob Red	Spring	Panel mounted	31,5 N	0,49	VA13-KS4
			Side mounted	31,5 N	0,32	VA13-KS
 	Knob Red Two positions	Knob/ Air signal	Panel mounted	6 N**	0,49	VA13-KL2A4
			Side mounted	6 N**	0,33	VA13-KL2A

* Panel holder in black anodized aluminium.

** Without signal pressure. Signal pressure min 3 bar at 6 bar supply pressure.



All VA13 valves (except VA13-WGR and VA13-RWG) can be connected either as normally closed 3/2 valve (NC) or normally open 3/2 valve (NO) as required, by connecting the primary air supply to Port 1 or Port 3.

M

Data

Working temperature: -20 °C to +70 °C
 Working pressure: max 10 bar
 Flow (acc. to ISO 6358)
 C: 0,9 NI/s, bar
 Qn (P1=6 bar, Δp=1 bar): 3,6 l/s
 Qmax: 6,3 l/s
 Cv: 0,21

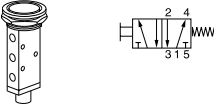
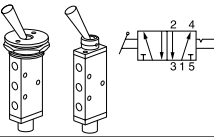
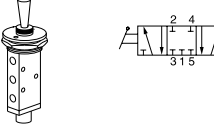
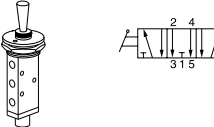
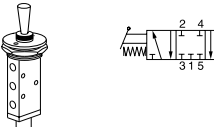
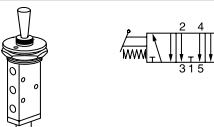
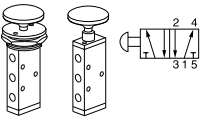
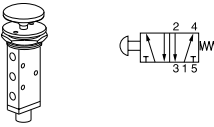
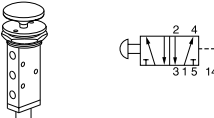



Symbol	Actuator	Return	Mounting	Changeover force at 6 bar	Weight kg	Order code
	Push-button Red	Spring	Panel mounted	34,5 N	0,46	VA15-HIS4
	Hand lever Held in two positions	Hand lever	Panel mounted	9 N	0,63	VA15-HB24
		Side mounted	9 N	0,45	VA15-HB2	
	Hand lever Held in three positions	Hand lever Closed centre position	Panel mounted	9 N	0,63	VA15-HB34
	Hand lever Held in three positions	Hand lever Exhausted centre position	Panel mounted	9 N	0,63	VA15-XHB34
	Hand lever Three positions self-centring	Hand lever	Panel mounted Closed centre position	9 N	0,63	VA15-HC4
	Hand lever Three positions self-centring	Hand lever	Panel mounted Exhausted centre position	9 N	0,63	VA15-XHC4
	Knob Red Two positions	Knob	Panel mounted	5 N	0,58	VA15-KL24
		Side mounted	5 N	0,42	VA15-KL2	
	Knob Red	Spring	Panel mounted	34,5 N	0,60	VA15-KS4
	Knob Red Two positions	Knob/Air signal	Panel mounted	8 N*	0,61	VA15-KL2A4

*Without signal pressure. Signal pressure min 3 bar at 6 bar supply pressure.

Data

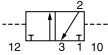

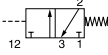

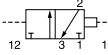
Working temperature: -20 °C to +70 °C
 Working pressure: max 10 bar
 Flow (acc. to ISO 6358)
 C: 0,9 NI/s, bar
 Qn (P1=6 bar, Δp=1 bar): 3,6 l/s
 Qmax: 6,3 l/s
 Cv: 0,21

VA13

	Symbol	Actuator	Return	Mounting	Signal pressure min, bar at 6 bar actu./return	Weight Kg	Order code
		Air signal	Air signal	Side mounted	3/3	0,33	VA13-AA
		Air signal	Spring	Side mounted	4/-	0,32	VA13-AS
		Air signal with priority	Air signal	Side mounted	3/4	0,32	VA13-ADA

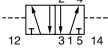
M

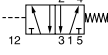
VA15

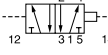





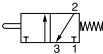

	Symbol	Actuator	Return	Mounting	Signal pressure min, bar at 6 bar actu./return	Weight Kg	Order code
		Air signal	Air signal	Side mounted	3/3	0,33	VA15-AA
		Air signal	Spring	Side mounted	4/-	0,32	VA15-AS
		Air signal with priority	Air signal	Side mounted	3/4	0,32	VA15-ADA

Data

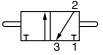

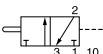
Working temperature -20 °C to +70 °C
 Working pressure: max 10 bar
 max 8 bar for WGR and RWG

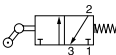
Flow (acc. to ISO 6358)

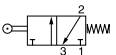
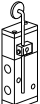
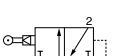
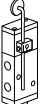
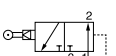
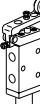
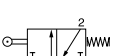
C: 0,9 NI/s, bar
 Qn (P1=6 bar, Δp=1 bar): 3,6 l/s
 Qmax: 6,3 l/s
 Cv: 0,21

	Symbol	Actuator	Return	Mounting	Changeover force at 6 bar	Weight kg	Order code
		Plunger	Spring	Side mounted	32,5 N	0,30	VA13-IS
		Plunger Two positions	Plunger	Side mounted	3 N	0,30	VA13-II
		Plunger	Air signal	Side mounted	6 N*	0,30	VA13-IA
		Roller one way trip	Spring	Side mounted	20,5 N	0,33	VA13-UWS
		Roller	Spring	Side mounted	32,5 N	0,33	VA13-WS
		Roller on an arm	Internal air min 4 bar	Side mounted Normally closed	0,6 N min	0,41	VA13-WGR
		Roller on an arm	Internal air min 4 bar	Side mounted Normally open	0,6 N min	0,41	VA13-RWG
		Roller	Spring	Side mounted		0,41	VA13-LRS

* Without signal pressure. Signal pressure min 3 bar at 6 bar supply pressure.

All VA13 valves (except VA13-WGR and VA13-RWG) can be connected either as normally closed 3/2 valve (NC) or normally open 3/2 valve (NO) as required, by connecting the primary air supply to Port 1 or Port 3.

Data

Working temperature: -20 °C to +70 °C
 Working pressure: max 10 bar
 max 8 bar for WGR

Flow (acc. to ISO 6358)

C: 0,9 NI/s, bar
 Qn (P1=6 bar, Δp=1 bar): 3,6 l/s
 Qmax: 6,3 l/
 Cv: 0,21

	Symbol	Actuator	Return	Mounting	Changeover force at 6 bar	Weight kg	Order code
		Plunger	Spring	Side mounted	34,5 N	0,40	VA15-IS
		Plunger Two positions	Plunger	Side mounted	5 N	0,40	VA15-II
		Roller one way trip	Spring	Side mounted	21,6 N	0,43	VA15-UWS
		Roller	Spring	Side mounted	34,5 N	0,44	VA15-WS
		Roller on an arm	Internal air min 4 bar	Side mounted	0,6 N min	0,46	VA15-WGR
		Roller	Spring	Side mounted		0,46	VA15-LRS

M

Dimensions

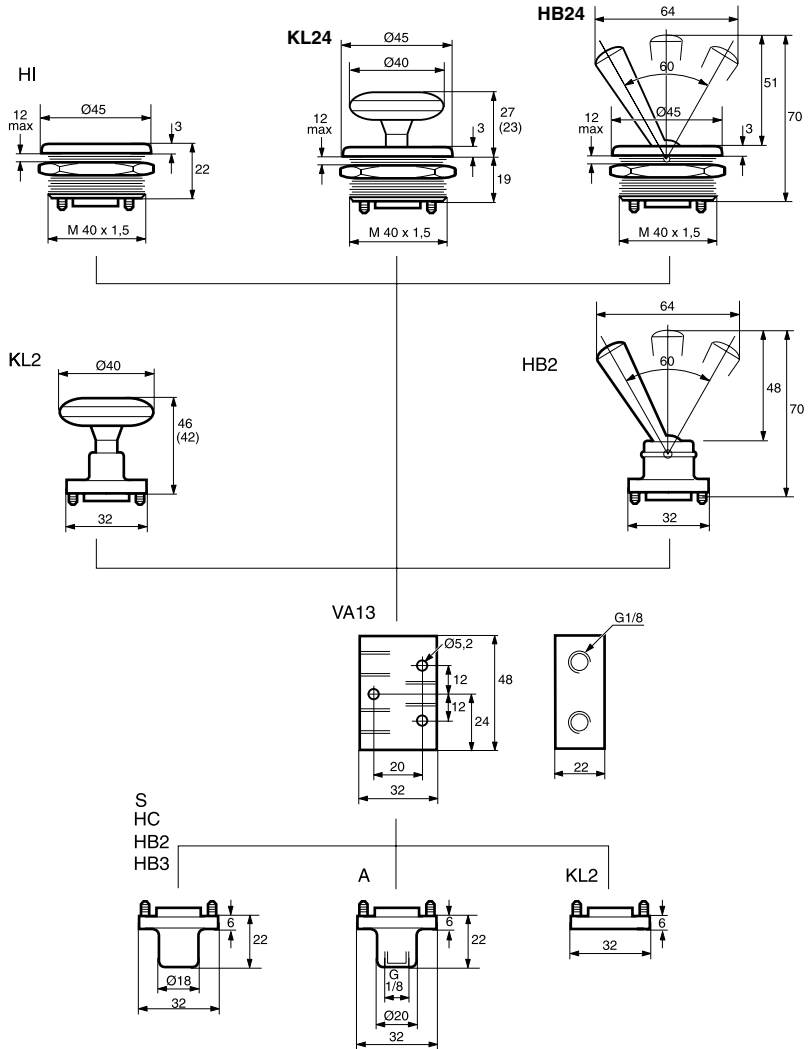

M

Dimensions

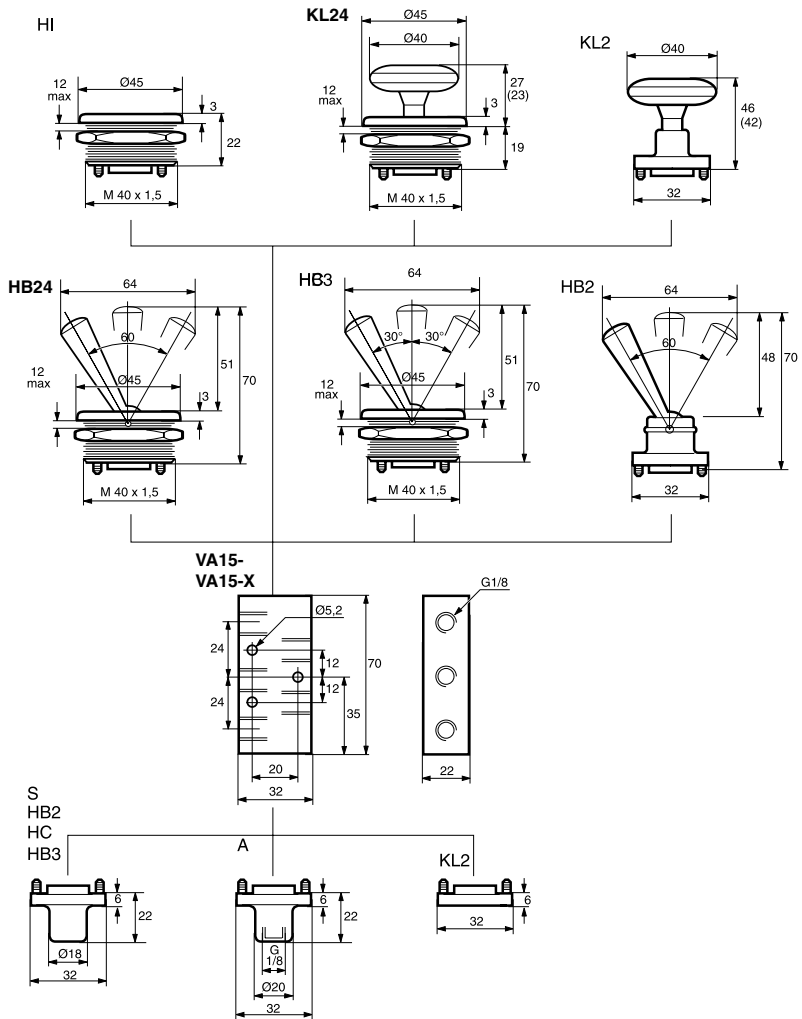

Dimensions

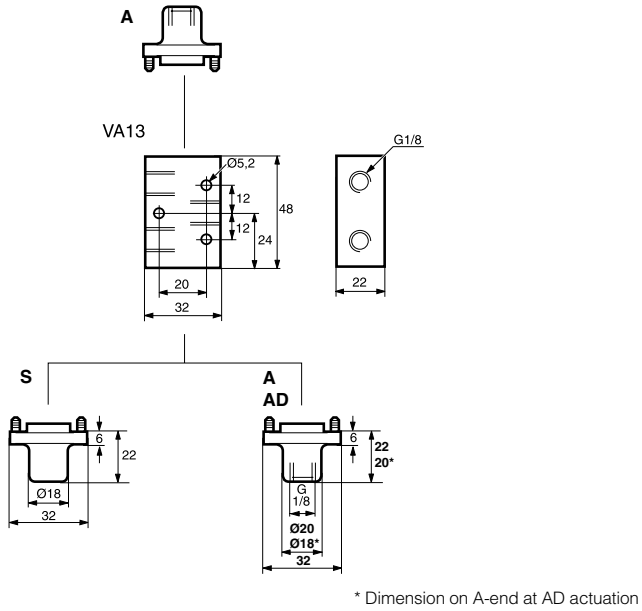

M

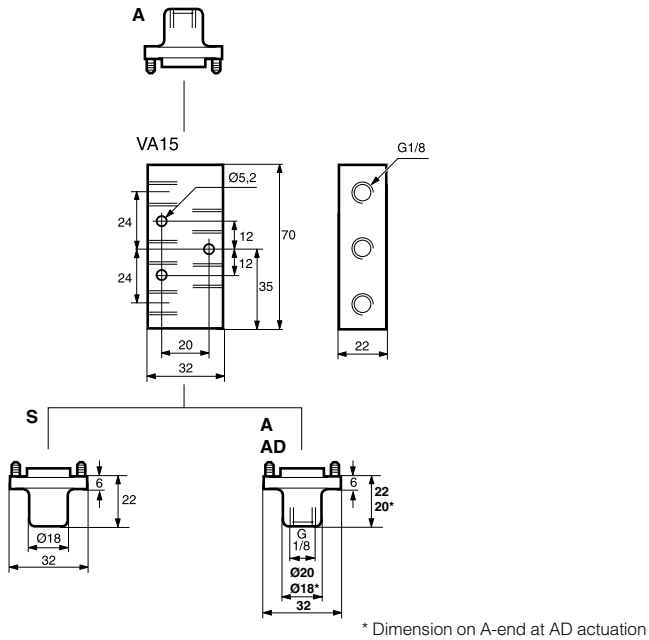

Dimensions

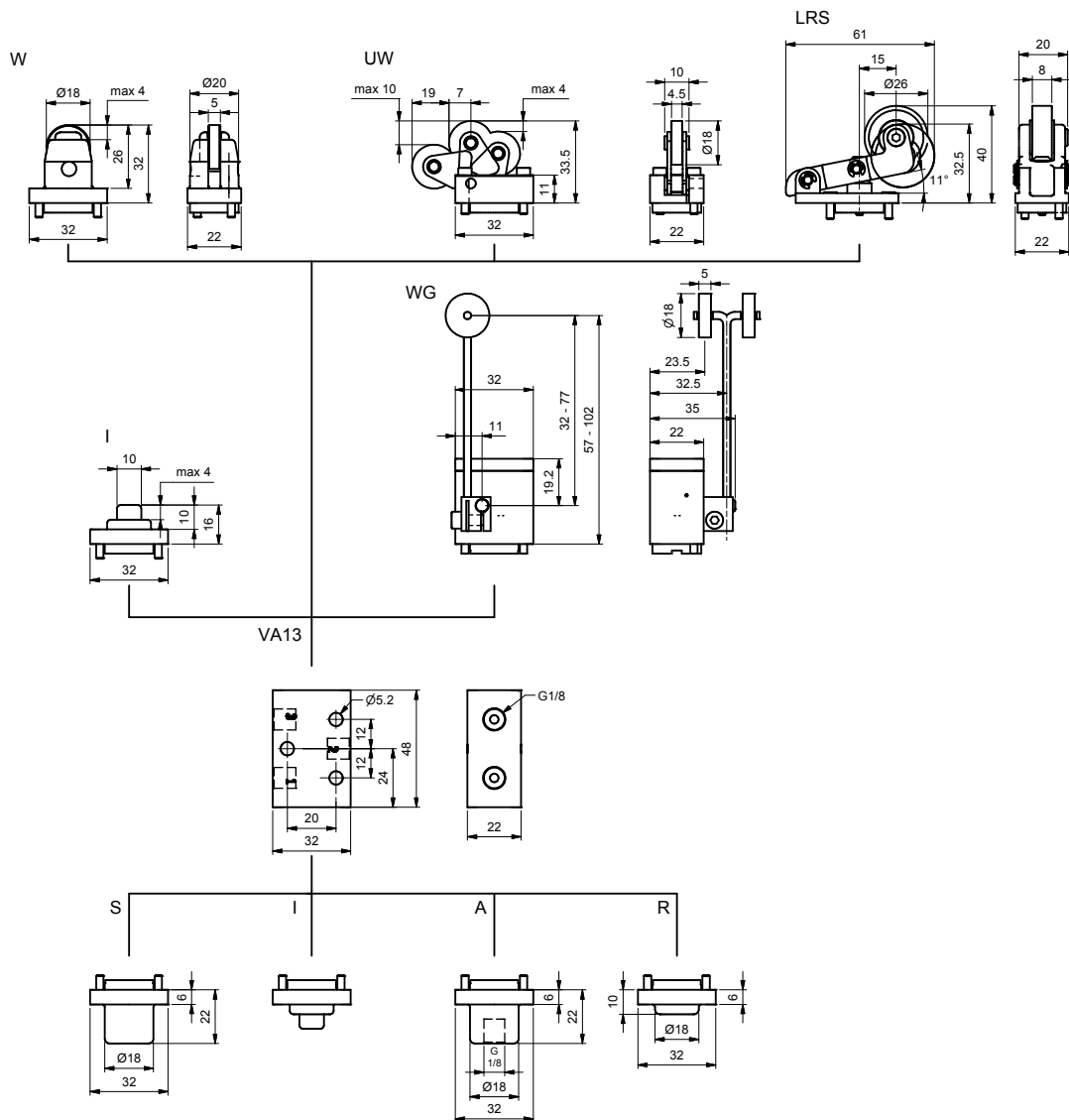

M

Dimensions

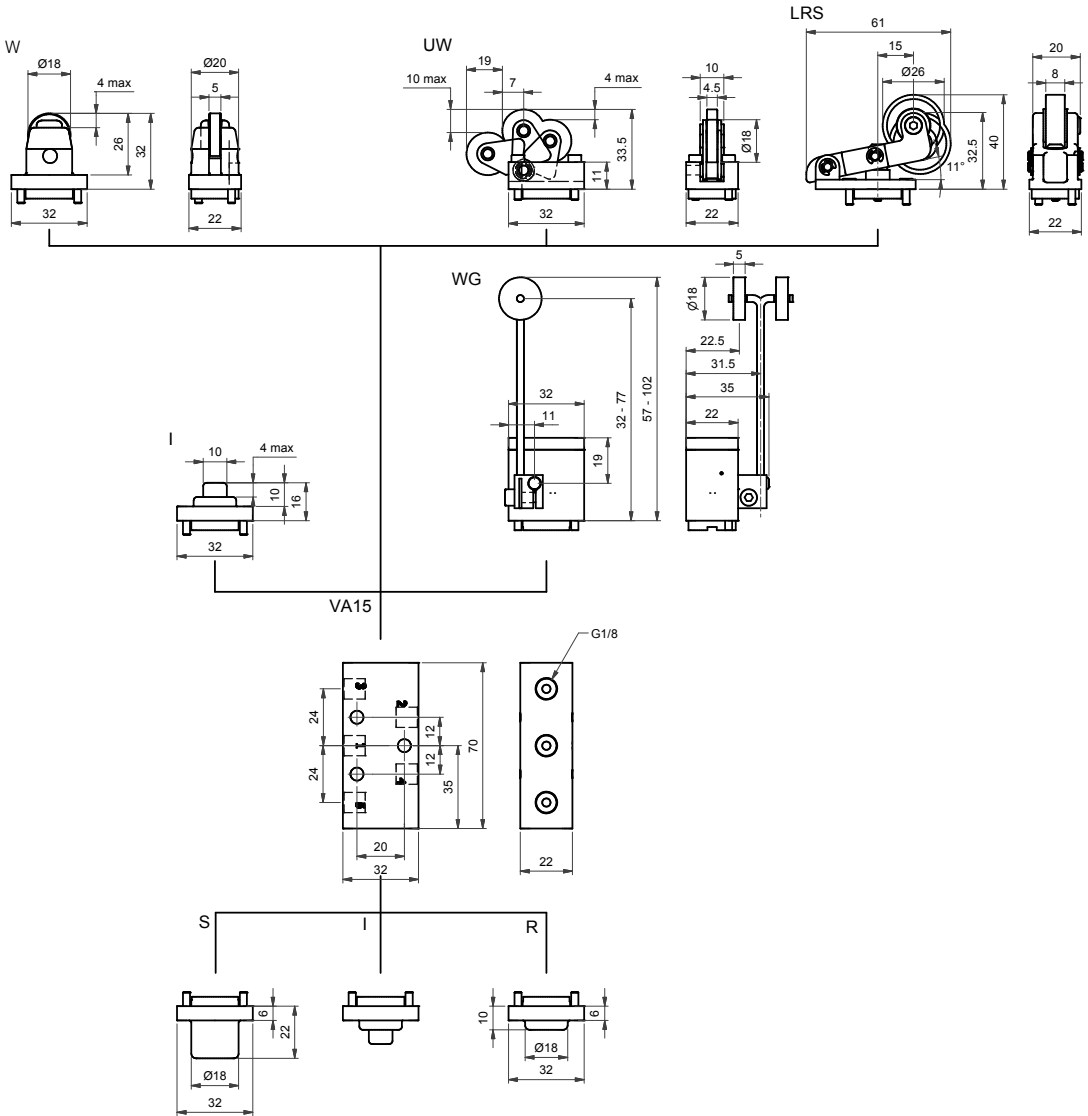

M

Accessories

Sintered bronze series

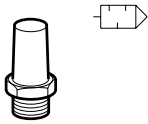

Port	Order code	Pack Qty
G1/8	9090050700	1

Male straight connectors - Parallel thread

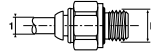

Tube Ø1	Thread B	Order code	Box Qty
4	1/8	F4PMB4-1/8	20
6	1/8	F4PMB6-1/8	30
8	1/8	F4PB8-1/8	40

Service and Replacement Parts

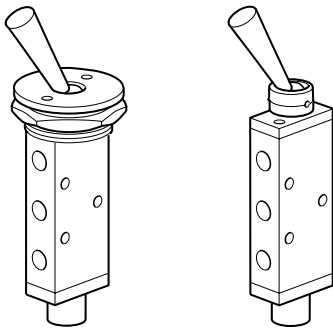

VA Series Heavy Duty Valves

Order code	Repair Kit
9128674100	Body seals (6 pcs. 'O' Ring)

M

M

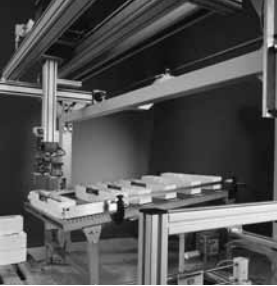

Heavy Duty Poppet Valves

G3/8, G1/2 - 2/2, 3/2

Control Devices

Heavy duty poppet valves

2/2 & 3/2 - G^{3/8}" & G^{1/2}"

These valves use the well proven poppet principle to give high flow rates with short valve travel, both the 2/2 and 3/2 valves in the range are available in G^{3/8}" and G^{1/2}" port sizes. This means that each actuator is available in four configurations i.e. 3/8" ports 2/2 or 3/2 and G^{1/2}" ports 2/2 or 3/2. All valves are normally closed.

The bodies are of block form construction for ease of mounting. Springs are stainless steel; internal seals being of nitrile rubber. The 2/2 body allows air in one direction only, 3/2 versions having the facility of exhausting air through the actuator unit. This exhaust vent is unthreaded on all valves except the pilot and solenoid types which allows the piping away of exhaust air.

All mechanisms are spring returned.

Working medium, air quality

Working medium: Dry, filtered compressed air to ISO 8573-1 class 3.4.3.

Recommended air quality for valves

For best possible service life and trouble free operation, ISO 8573-1 quality class 3.4.3 should be used. This means 5µm filter (standard filter) dew point +3°C for indoor operation (a lower dew point should be selected for outdoor operation) and oil concentration 1.0 mg oil/m³, which is what a standard compressor with a standard filter gives.

ISO 8573-1 quality classes

Quality class	Pollution		Water max. press. dew point (°C)	Oil max. concentration (mg/m ³)
	particle size (µm)	max. concentration (mg/m ³)		
1	0,1	0,1	-70	0,01
2	1	1	-40	0,1
3	5	5	-20	1,0
4	15	8	+3	5,0
5	40	10	+7	25
6	-	-	+10	-

Specification

Material

Body	Zinc die cast
Roller	Zinc plated steel
Mechanical arm	Zinc plated steel
Poppet	Stainless steel
Seals	Nitrile
Spring	Stainless steel
Bush	Aluminium
Piston	Aluminium

Operating information

Working pressure	0 - 10 bar
Working temperature	-10°C to +80°C
Solenoid version	-10°C to +50°C
Minimum pilot pressure	1.9 bar @ 6 bar supply
Response time (solenoid energised)	14 msecs
Response time (solenoid de-energised)	75 msecs

Flow capacities in accordance with ISO6358

	B102-B103	B202-B203
Flow;	C = 7,54	C = 10,75 NI/s x bar
	b = 0,29	b = 0,24
	Qn = 33 l/s	Qn = 43 l/s
	Qmax = 54 l/s	Qmax = 75 l/s
	Cv = 2,65	Cv = 3,20

Part number configurator for solenoid valves

Valve family	
DB	HD poppet solenoid operated

Thread port	
1	3/8 BSP
2	1/2 BSP

Air supply to solenoid	
2	Internal

Overrides	
A	None
C	Flush - Locking
D	Extended - non locking

Function	
2	2/2 NC
3	3/2 NC

Voltage ¹		
	AC	DC
	60Hz	50Hz
40	12	
42	24	22
45		12
49		24
53	120	110
57	240	230
XX	valve less solenoid/coil	

¹ Shaded part numbers are standard
 Unshaded part numbers are available on request but will be subject to minimum order quantities
 Otherwise order XX version and order coil separately.

Part number configurator for manual & mechanical operated poppet valves

Valve family	
B	HD poppet manual & mechanical

Thread port	
1	3/8 BSP
2	1/2 BSP

Function	
2	2/2 NC
3	3/2 NC

Operator	
C	Ball
L	Lever
P	Pilot pressure
R	Roller lever

N

Flow characteristics

Flow capacities in accordance with ISO6358
 Flow measured with valve on manifold
 All pressures = effective pressure

B102

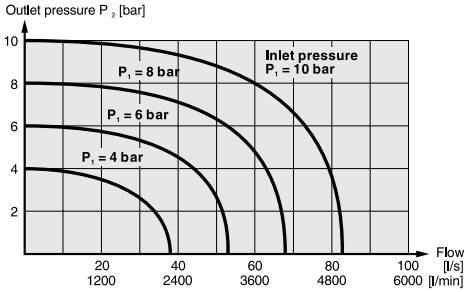

B202

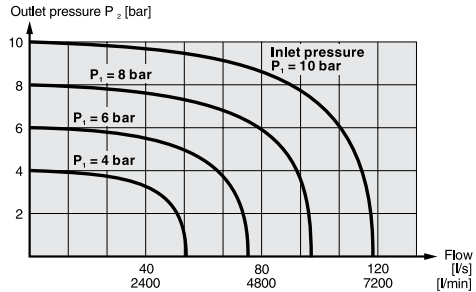

Electrical Information

Power consumption	Inrush	Hold
	AC VA	8.5VA
	DC 4.8 Watt	
Rating	100% continuous	
Isolation class	F	
Protection class	IP 65 (P 54) DIN 40 050	
Connection	DIN 43 650 Form B	
Solenoid response	milliseconds at 7 bar	







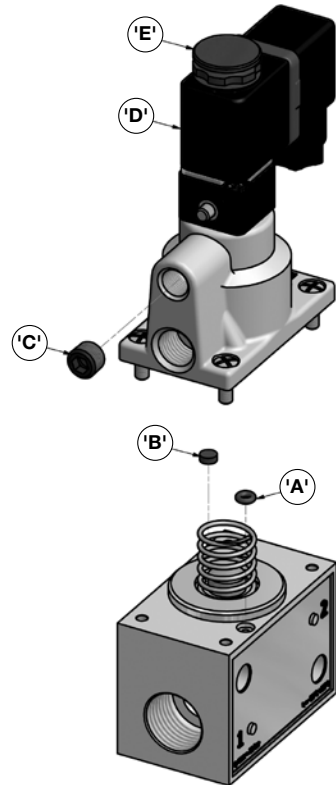

External pilot supply option

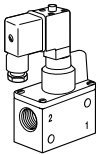
Solenoid pilot operated valves have an internal pilot air supply, but provisions for external pilot supply is provided. To use with external supply interchange 'O'-ring (Item 'A') and Plug (Item 'B') to block off the internal pilot supply. Remove hexagon socket plug (Item 'C') from the external pilot supply port, connecting an air supply as desired.

Orientation of the solenoid coil (Item 'D') can be altered through 90° increments by loosening the diffuser nut (Item 'E').

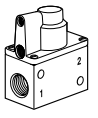









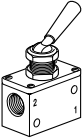

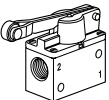

Main data for mechanically operated valves, Heavy duty poppet series (NC only)

	Symbol	Type	Connection	Actuator	Return	Voltage	Weight Kg	Order code
		2/2	G3/8	Solenoid pilot	Spring	24VDC Less solenoid	0.70 0.65	DB122A49 DB122AXX
		3/2	G3/8	Solenoid pilot	Spring	24VDC Less solenoid	0.70 0.65	DB123A49 DB123AXX
		2/2	G1/2	Solenoid pilot	Spring	24VDC Less solenoid	0.70 0.65	DB222A49 DB222AXX
		3/2	G1/2	Solenoid pilot	Spring	24VDC Less solenoid	0.70 0.65	DB223A49 DB223AXX
		2/2	G3/8	Air pilot	Spring		0.61	B102P
		3/2	G3/8	Air pilot	Spring		0.61	B103P
		2/2	G1/2	Air pilot	Spring		0.61	B202P
		3/2	G1/2	Air pilot	Spring		0.61	B203P

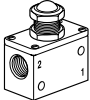
N

Main data for mechanically operated valves, Heavy duty poppet series (NC only)

Symbol	Type	Connection	Actuator	Return	Operating force at 6 bar, N	Weight Kg	Order code	
	2/2	G3/8	Lever	Lever	22	0.65	B102L	
		3/2	G3/8	Lock down lever	Lever	22	0.65	B103L
		2/2	G1/2	Lock down lever	Lever	22	0.65	B202L
		3/2	G1/2	Lock down lever	Lever	22	0.65	B203L
			2/2	G3/8	Roller lever	Spring	36	0.642
		3/2	G3/8	Roller lever	Spring	36	0.630	B103R
		2/2	G1/2	Roller lever	Spring	36	0.614	B202R
		3/2	G1/2	Roller lever	Spring	36	0.604	B203R
		2/2	G3/8	Ball	Spring	220	0.542	B102C
		3/2	G3/8	Ball	Spring	220	0.532	B103C
		2/2	G1/2	Ball	Spring	220	0.530	B202C
		3/2	G1/2	Ball	Spring	220	0.520	B203C

N

Mechanically operated valves - 2/2, 3/2 valves

Basic body dimensions

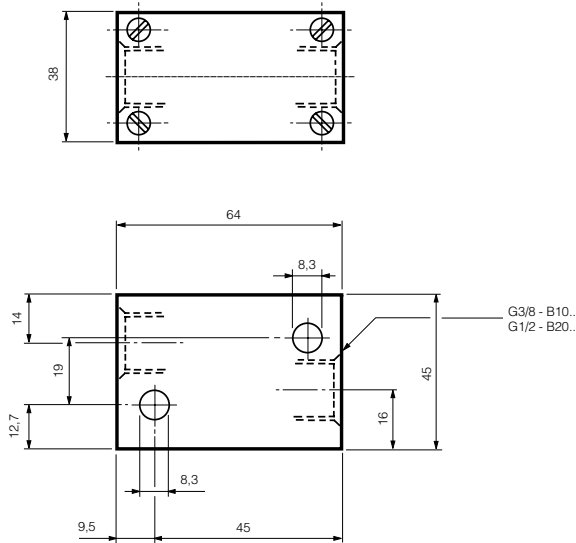

Solenoid pilot operated spring return
 DB122, DB123, DB222, DB223

Air pilot operated spring return
 B102P, B103P, B202P, B203P

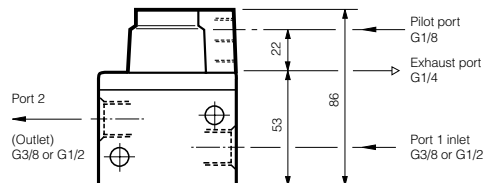
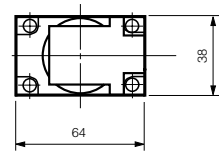
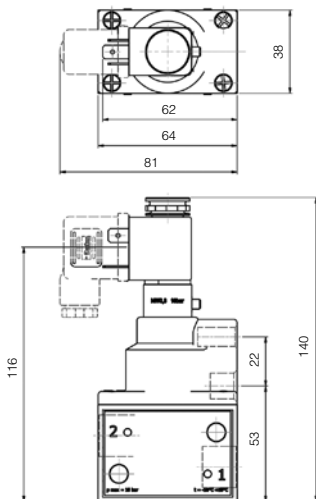

All dimensions in mm unless otherwise stated

Mechanically operated valves - 2/2, 3/2 valves

Lock down lever

B102L, B103L, B202L, B203L

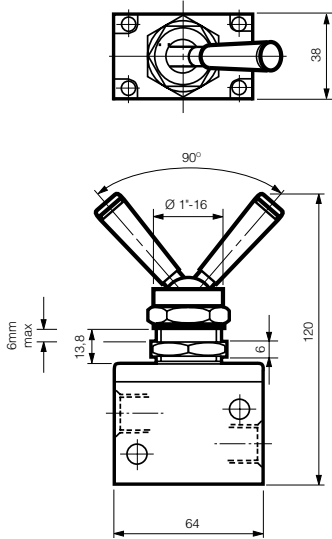

Roller lever operated spring return

B102R, B103R, B202R, B203R

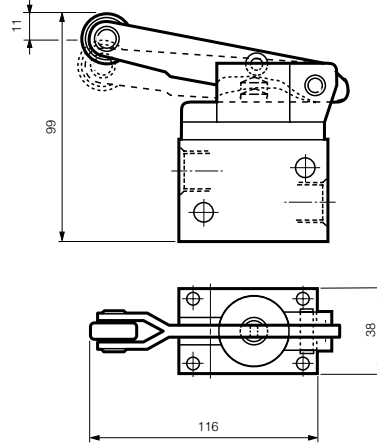

Ball operated spring return

B102C, B103C, B202C, B203C

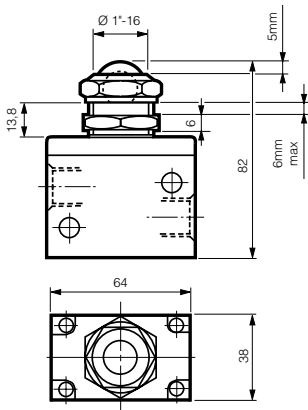

N

All dimensions in mm unless otherwise stated

22mm solenoid operator part numbers and spares

Solenoid coils for 22mm solenoid operators

Voltage	Order code Form B	Weight (Kg)
12V 60Hz	P2FCB440	0.093
24V 50/60Hz	P2FCB442	0.093
12V DC	P2FCB445	0.093
12V DC Mobile	P2FCB447	0.093
24v DC Mobile	P2FCB448	0.093
24V DC	P2FCB449	0.093
48V DC	P2FCB451	0.093
110V/50Hz, 120V/60Hz	P2FCB453	0.093
230V/50Hz, 230V/60Hz	P2FCB457	0.093

Spare Solenoid Nuts

Valves with vented exhaust are fitted with diffuser plastic nut

Order Code

P2FND

Spare Solenoid Operators

Solenoid pilot operator 22mm NC, Normal duty (Max Operating pressure 10bar, Temp -10°C to +50°C)



Order code (with locking bi-stable m/o)	Weight Kg
P2FP13N4C	0.05
Order code (with Non-locking monostable m/o)	Weight Kg
P2FP13N4D	0.05
Order code (with no m/o)	Weight Kg
P2FP13N4A	0.05

Note.

The operators are supplied with mounting screws and interface 'O' rings.

Coils and connectors must be ordered separately.

Solenoid Connectors / Cable Plugs EN175301-803

	Description	Order code 22mm Industrial Form B
With standard screw	Standard IP65 without flying lead	3EV10V10
	With LED and protection 24V AC/DC	3EV10V20-24
	With LED and protection 110V AC	3EV10V20-110
	With LED and protection 230V AC	3EV10V20-230
With cable	24V AC/DC, 5m cable LED and protection IP65	3EV10V20-24L5
	110V AC/DC, 5m cable LED and protection IP65	3EV10V20-110L5
	230V AC, 5m cable LED and protection IP65	3EV10V20-230L5

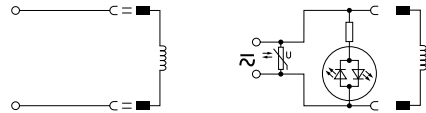

3EV10V10

3EV10V20-24	3EV10V20-24L5
3EV10V20-110	3EV10V20-110L5
3EV10V20-230	3EV10V20-230L5

N

Cable Plug Dimensions (mm)

Solenoid operators P2E-•V...

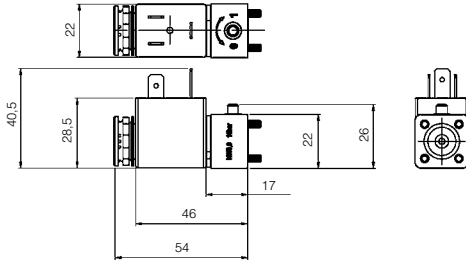

Cable plugs Form B

3EV10V10

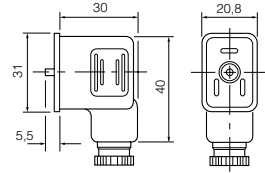

Accessories

Sintered bronze series silencers

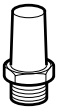

Port	Order code	Pack Qty
G1/4	P6M-BAA2	1

Male straight connectors - Parallel thread

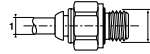

Tube Ø1	Thread B	Order code	Box Qty
4	1/8	F4PMB4-1/8	20
6	1/8	F4PMB6-1/8	30
6	1/4	F4PMB6-1/4	30
8	1/8	F4PB8-1/8	40
8	1/4	F4PB8-1/4	30
8	3/8	F4PB8-3/8	20
10	1/4	F4PB10-1/4	20
10	3/8	F4PB10-3/8	20
10	1/2	F4PB10-1/2	10
12	1/4	F4PB12-1/4	10
12	3/8	F4PB12-3/8	10
12	1/2	F4PB12-1/2	10
14	3/8	F4PB14-3/8	10
14	1/2	F4PB14-1/2	10

N

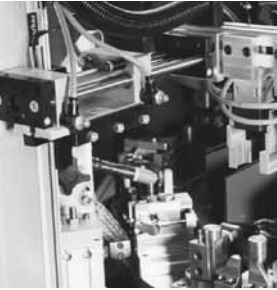

Limit Switches, Bleed Sensors

- High durability
- Very good repeat accuracy
- Design for process duty cycle
- Push-in or threaded connection
- Versatile and easily maintained
- Wide range of body size and actuator style



Operating information

Working pressure;
 PXC-M101, PXC-M111, PXC-M121,
 PXC-M521, PXC-M601,

PXC-J: 3-8 bar
 PXC-K: 3-9 bar

Working temperature -15 °C to +60 °C

	PXC-M101	PXC-M111	PXC-M121	PXC-M521/ PXC-M601
Flow: (acc. to ISO 6358)	Qmax= 60	60	85	250 l/s
Flow: (acc. to ISO 6358)		PXC-K 210	PXC-J 210 l/s	



3/2 miniatures limit switches

With Ø4 mm Push-in connections (M5 on request)

Bore Ø1,5 mm, flow 60 NI/min

Symbol	Actuator	Return	Operating forces at 6 bar, N	Version	Weight kg	Order code
	Steel plunger	Spring	11	NC	0,030	PXC-M111
	Steel plunger	Spring	11	NO	0,030	PXC-M101

Operating levers



Plastic roller lever	0,008	PXC-Z11
Plastic roller lever, one way trip	0,008	PXC-Z12

Bore Ø1,5 mm, flow 85 NI/min

Symbol	Actuator	Return	Operating forces at 6 bar, N	Weight kg	Order code
	Plastic roller	Spring	4,5	0,040	PXC-M121
	Steel roller	Spring	4,5	0,045	PXC-M131

Bore Ø2,5 mm, flow 250 NI/min

Symbol	Actuator	Return	Operating forces at 6 bar, N	Weight kg	Order code
	Plastic roller	Spring	7	0,060	PXC-M521





3/2 compact limit switches

With Ø4 mm Push-in connections
with pipeable exhaust port

Bore Ø2,5 mm, flow 250 NI/min

With plunger head

Symbol	Actuator	Return	Operating forces at 6 bar, N	Weight kg	Order code
	Steel plunger	Spring	24	0,150	PXC-M601A110











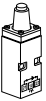

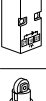

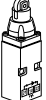

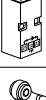

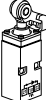

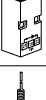

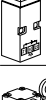

	Symbol	Actuator	Return	Operating forces at 6 bar, N	Weight kg	Order code
		Steel roller plunger	Spring	24	0,160	PXC-M601A102
		90° steel roller plunger	Spring	24	0,160	PXC-M601A103

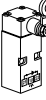
3/2 limit switches “K series”

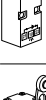
With Ø4 mm Push-in connections
with pipeable exhaust port
snap action and low operating force

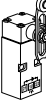
Bore Ø3 mm

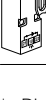
With plunger

	Symbol	Actuator	Return	Operating forces at 6 bar, N	Weight kg	Order code
		Steel plunger	Spring	16 N	0,270	PXC-K21101
		Steel plunger	Spring	16 N	0,270	PXC-K22101
		Steel roller plunger	Spring	16 N	0,310	PXC-K21102
		Steel roller plunger	Spring	16 N	0,310	PXC-K22102
		Plastic roller plunger	Spring	16 N	0,320	PXC-K21121
		Plastic roller plunger	Spring	16 N	0,320	PXC-K22121
		Whisker	Spring	0,05 Nm	0,270	PXC-K21106
		Whisker	Spring	0,05 Nm	0,270	PXC-K22106
		Plastic roller lever *	Spring	0,21 Nm	0,360	PXC-K2110531
		Plastic roller lever *	Spring	0,21 Nm	0,360	PXC-K2210531
		Adjustable lever with Delrin roller *	Spring	0,21 Nm	0,360	PXC-K2110541
		Adjustable lever with Delrin roller	Spring	0,21 Nm	0,360	PXC-K2210541



* Direction of actuation can be set as required

- from right and left
- from right
- from left



3/2 limit switches “K series”

Bore Ø3 mm

Pneumatic switch bodies, for use in association with all **ZCK-D..** series operating heads

Symbol	Actuator	Return	Operating forces at 6 bar, N	Weight kg	Order code
	-	-	16	0,320	PXC-K211
	-	-	16	0,320	PXC-K221

Pneumatic switch bodies with rotary heads
 Direction of actuation can be set as required:
 - From right and left
 - From right
 - From left

Symbol	Actuator	Return	Operating forces at 6 bar, Nm	Weight kg	Order code
	Rotary head	Spring	0,21	0,340	PXC-K21105
	Rotary head	Spring	0,21	0,340	PXC-K22105

	Actuator	Weight kg	Order code
Rod 	Ø3 mm fibre glass	0,025	ZCK-Y55
	Square steel 3 mm	0,025	ZCK-Y54

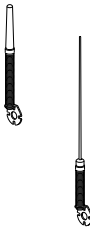







	Actuator	Weight kg	Order code
Spring rod 	Plastic	0,010	ZCK-Y81
	Metal	0,030	ZCK-Y91

3/2 limit switches “J series”





With **Ø4 mm Push-in connections** (M5 or G1/8 on request)
 With pipeable exhaust port
 Snap action and low operating force

Bore Ø3 mm











With plunger head

	Symbol	Actuator	Return	Operating forces at 6 bar, N	Weight kg	Order code
		Steel plunger	Spring	16	0,515	PXC-J11161
		Steel plunger	Spring	16	0,515	PXC-J12161
		Steel roller plunger	Spring	16	0,525	PXC-J11162
		Steel roller plunger	Spring	16	0,525	PXC-J12162
		Whisker	Spring	16	0,510	PXC-J11170
		Whisker	Spring	16	0,510	PXC-J12170

With rotary head and operating lever

	Symbol	Actuator	Direction of actuation	Return	Operating forces at 6 bar, N	Weight kg	Order code
		Rigid rod	Right AND left	Spring	0,05	0,570	PXC-J1110151
		Rigid rod	Right AND left	Spring	0,05	0,570	PXC-J1210151
		Rigid rod	Right OR left	Spring	0,05	0,570	PXC-J1110551
		Rigid rod	Right OR left	Spring	0,05	0,570	PXC-J1210551

With rotary head and operating lever

	Symbol	Actuator	Direction of actuation	Return	Operating forces at 6 bar, N	Weight kg	Order code
		Delrin roller lever	Right AND left	Spring	0,25	0,565	PXC-J1110111
				Spring	0,25	0,565	PXC-J1210111
		Delrin roller lever	Right OR left	Spring	0,25	0,565	PXC-J1110511
				Spring	0,25	0,565	PXC-J1210511
		Variable length lever with thermoplastic roller	Right AND left	Spring	0,25	0,580	PXC-J1110131
				Spring	0,25	0,580	PXC-J1210131
		Variable length lever with thermoplastic roller	Right OR left	Spring	0,25	0,580	PXC-J1110531
				Spring	0,25	0,580	PXC-J1210531









3/2 limit switches “J series”

With G1/8 connection





With pipeable exhaust port
Snap action and low operating force

Bore Ø3 mm











With plunger head

	Symbol	Actuator	Return	Operating forces at 6 bar, N	Weight kg	Order code
		Steel plunger	Spring	16	0,515	PXC-J11861
		Steel plunger	Spring	16	0,515	PXC-J12861
		Steel roller plunger	Spring	16	0,525	PXC-J11862
		Steel roller plunger	Spring	16	0,525	PXC-J12862
		Whisker	Spring	16	0,510	PXC-J11870
		Whisker	Spring	16	0,510	PXC-J12870

With rotary head and operating lever

	Symbol	Actuator	Direction of actuation	Return	Operating forces at 6 bar, Nm	Weight kg	Order code
		Rigid rod	Right AND left	Spring	0,05	0,570	PXC-J1180151
		Rigid rod	Right AND left	Spring	0,05	0,570	PXC-J1280151
		Rigid rod	Right OR left	Spring	0,05	0,570	PXC-J1180551
		Rigid rod	Right OR left	Spring	0,05	0,570	PXC-J1280551

With rotary head and operating lever



	Symbol	Actuator	Direction of actuation	Return	Operating forces at 6 bar, Nm	Weight kg	Order code
		Delrin roller lever	Right AND left	Spring	0,25	0,565	PXC-J1180111
				Spring	0,25	0,565	PXC-J1280111
		Delrin roller lever	Right OR left	Spring	0,25	0,565	PXC-J1180511
				Spring	0,25	0,565	PXC-J1280511
		Variable length lever with thermoplastic roller	Right AND left	Spring	0,25	0,580	PXC-J1180131
				Spring	0,25	0,580	PXC-J1280131
		Variable length lever with thermoplastic roller	Right OR left	Spring	0,25	0,580	PXC-J1180531
				Spring	0,25	0,580	PXC-J1280531





3/2 limit switches “J series”





With Ø4 mm Push-in connections

Bore Ø3 mm

Pneumatic switch bodies*
 For use in association with all **ZC2-JC••**
 operating heads

Symbol	Actuator	Return	Operating forces at 6 bar, N	Weight kg	Order code
		-	Spring	16	0,320 PXC-J111
		-	Spring	16	0,320 PXC-J121

Symbol	Actuator	Direction of actuation	Return	Operating forces at 6 bar, Nm	Weight kg	Order code
		-	Right AND left	Spring	0,05	0,535 PXC-J11101
		-	Right AND left	Spring	0,05	0,535 PXC-J12101
		-	Right OR left	Spring	0,05	0,535 PXC-J11105
		-	Right OR left	Spring	0,05	0,535 PXC-J12105

	Actuator	Weight kg	Order code
	Steel roller lever	0,040	ZC2-JY13
	Spring plastic rod	0,040	ZC2-JY81
	Spring metal rod	0,040	ZC2-JY91
	Variable length lever with delrin roller	0,050	ZC2-JY41

* The switch bodies are available with G1/8 threaded connection.
 Replace the 3rd digit in the reference by 8. Example PXC-J11861



3/2 limit switches “J series”





With G1/8 connection





Bore Ø3 mm

Pneumatic switch bodies*

For use in association with all **ZC2-JC**** operating heads

Symbol	Actuator	Return	Operating forces at 6 bar, N	Weight kg	Order code
	-	-	16	0,320	PXC-J118
	-	-	16	0,320	PXC-J128

Symbol	Actuator	Direction of actuation	Return	Operating forces at 6 bar, Nm	Weight kg	Order code
	-	Right AND left	Spring	0,05	0,535	PXC-J11801
	-	Right AND left	Spring	0,05	0,535	PXC-J12801
	-	Right OR left	Spring	0,05	0,535	PXC-J11805
	-	Right OR left	Spring	0,05	0,535	PXC-J12805

Actuator	Weight kg	Order code
 Steel roller lever	0,040	ZC2-JY13
 Spring plastic rod	0,040	ZC2-JY81
 Spring metal rod	0,040	ZC2-JY91
 Variable length lever with delrin roller	0,050	ZC2-JY41

Dimensions, Limit switches, Series PXC

3/2 miniature limit switches

PXC-M111

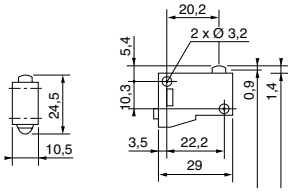

PXC-Z12

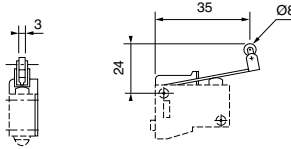

PXC-Z11

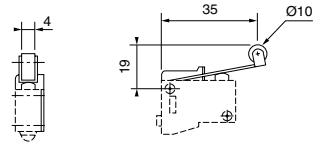

PXC-M121 - PXC-M131

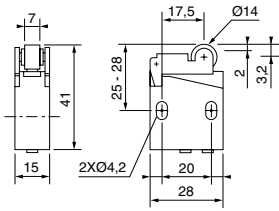

PXC-M521

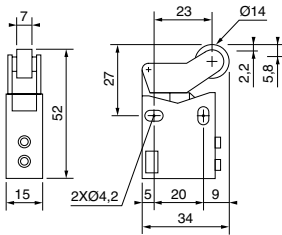

3/2 compact limit switches

PXC-M601A102

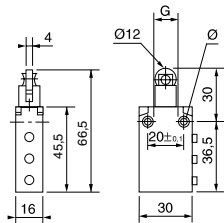

PXC-M601A103

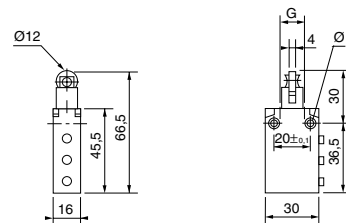

PXC-M601A110

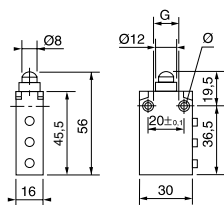

With plunger heads

PXC-K21101, PXC-K22101

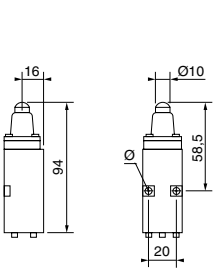

PXC-K21102, PXC-K22102

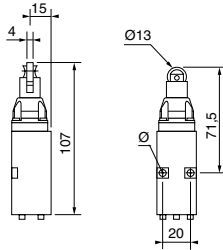

PXC-K21121, PXC-K22121

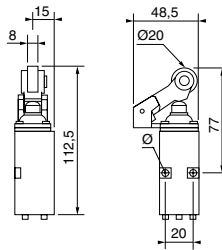

PXC-K21106, PXC-K22106

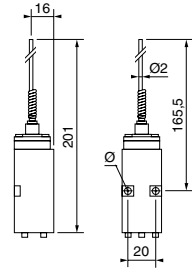

With rotary heads and operating levers

PXC-K21110531, PXC-K22110531

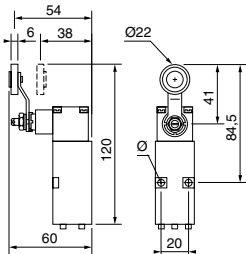

PXC-K21110541, PXC-K22110541

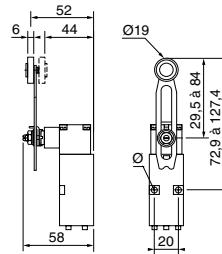

Ø=2 holes Ø5,2 mm

With rotary heads and operating levers

ZCK-Y54, ZCK-Y55

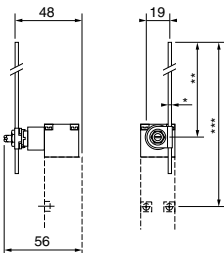

ZCK-Y55	ZCK-Y54
* Ø3	Ø 3
** 11 to 115	11 to 115
*** 53 to 158	53 to 158

ZCK-Y81

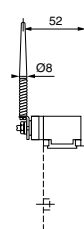

ZCK-Y91

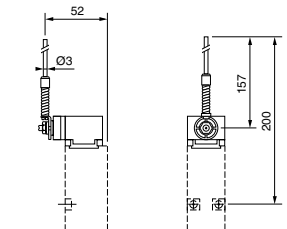

Pneumatic switch bodies

PXC-K211, PXC-K221

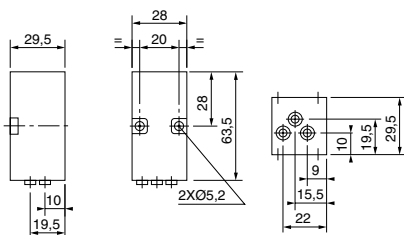

With plunger heads

PXC-J11161, PXC-J12161 PXC-J11162, PXC-J12162 PXC-J11170, PXC-J12170

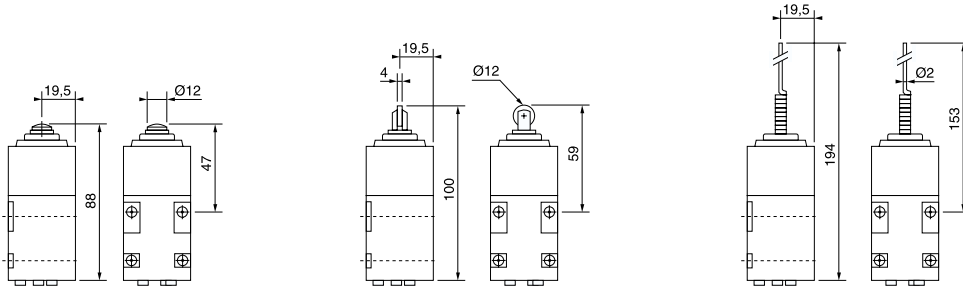

With rotary heads and operating levers

PXC-J111011, J1210111, J1110511, J1210511 PXC-J1110131, J1210131, J1110531, J1210531 PXC-J1110151, J1210151, J1110551, J1210551

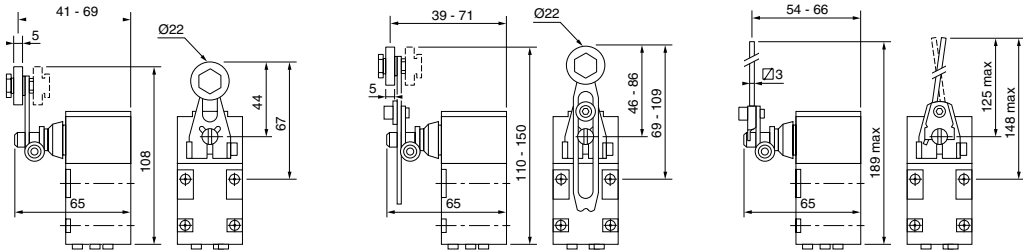

With rotary heads and operating levers

ZC2-JY81 ZC2-JY91 ZC2-JY41

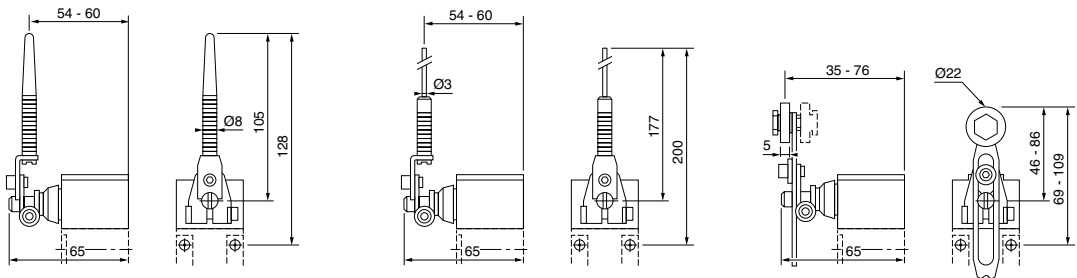





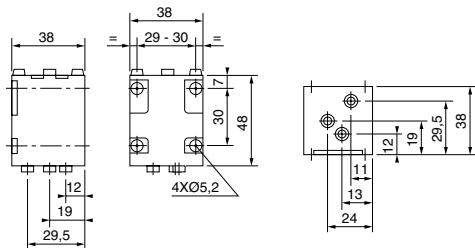

Pneumatic switch bodies

PXC-J111, PXC-J121



Bleed sensors

For use with PRF-A12 relay

	Symbol	Connection	Actuator	Return	Operating forces at 6 bar, N	Weight kg	Order code
		Ø4 mm Push-in	Direct	-	3 N	0,030	PXF-A111
		M5	Direct	-	3 N	0,030	PXF-A115
		Ø4 mm Push-in	Ball roller	Spring	3 N	0,035	PXF-A121
		M5	Ball roller	Spring	3 N	0,035	PXF-A125
		Ø4 mm Push-in	Whisker	Spring	0,125 Nm	0,035	PXF-A131
		M5	Whisker	Spring	0,125 Nm	0,035	PXF-A135

Bleed sensor relay

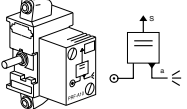
Symbol	Connection	Function	Weight kg	Order code
	Ø4 mm Push-in	Provides a supply to a bleed sensor and generates a pneumatic signal equal to its supply pressure when the bleed sensor operates	0,070	PRF-A12

Application

Bleed sensors make it possible to sense very low actuating forces or small movements and are very compact. They are easy to install and connect as they only require a single tube. However, the length of the interconnecting tube must remain short if quick response times are required.

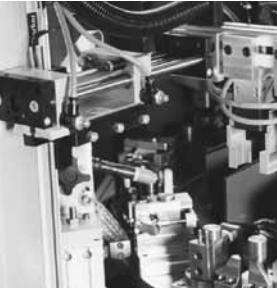

P

Logic Processing

Modular sequencer, inline/modular logic elements, bus mounted elements, relays, electrical operators, impulse-counters, timers

Line mounted logic elements

These can either be mounted along the length of the line or located in an enclosure.

Two logic functions are available with this model : AND and OR.



Combinable logic elements

These elements can be combined with each other enabling the assembly of compact logic blocks. Three logic functions are provided : AND - OR and inhibition NOT.

In addition to the combination assembly by integral key, each logic element includes a mode selector which enables, simply by pivoting the selector, a choice between cascade mode or common, input mode :

- cascade mode means that the element output corresponds to the input of the following element ;
- common input mode sends one of the element's inputs to an input of the following element.

The logic block obtained in this way for each applications are mounted in an enclosure on standard Omega rail, are connected by instant connections and carry, on the front, their internal diagram to facilitate any intervention.



Selector in cascade position Selector in common position

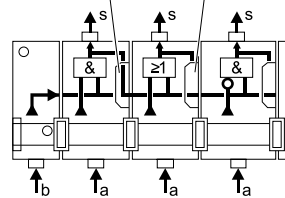

Sub-base mounting logic elements

As an alternative, it is possible to use logic element suitable for mounting on 3-port sub-bases, the interconnections being made by the sub-bases.

The following can be used :

- 3-port sub-bases with common pressure, with common used as "input common" ;
- 3-port "cascade" sub-bases.



P

The specialized relays mounted on stacking sub-bases are complementary to the sequencers and logic elements.

According to the relay, it can be used a 3-port or a 4-port sub-base.



3-port sub-bases

These are designed for the mounting of :

- timers,
- relays for bleed sensors,
- pressure operated electrical contacts.



4-ports sub-bases

These are designed for the mounting of :

- memory relays,
- amplifier relays for fluidic proximity sensors.

The standard configuration enables the use of a single pressure supply to all the relays by the centre ports ; this is why the stacking "common pressure" sub-bases, with either 3 or 4 ports, are all designed to be used singly or combined in a bank traversed by a pressure common.

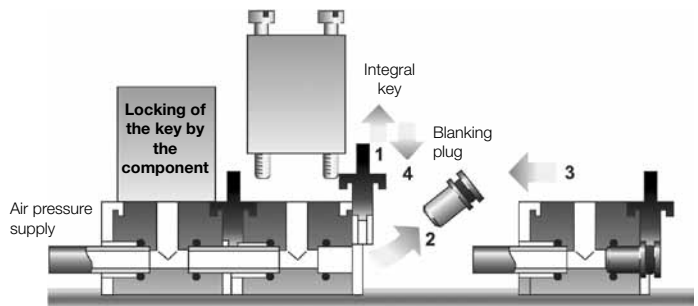

P

Production machines fitted with pneumatic cylinders generally repeat a defined sequential cycle. The pneumatic sequencer commands and controls the correct operation of the required cycle.

Composition

The pneumatic sequencer comprises :

- the stage modules corresponding to the cycle to be run : a module is used for each stage of the GRAFCET function chart ;
- the two modules, head and tail, interlock the association of the module onto Omega rail and enable the connection of the pressure common, of the reset to zero and the connection loops between the last and the first module.

A deviation module is fitted between the step modules to intercept the inter-module signals when the cycle includes parallel elements, restarts or the skipping of a step.

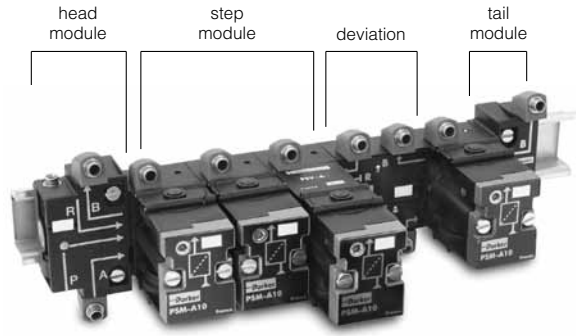

Dialogue

The pneumatic sequencer facilitates the machine adjustment dialogue and the optional dialogue.

At the step module level, dialogue items include :

- a step indicator which signals the step activated ;
- step reference marking ;
- manual overrides for resetting the module to 0 or to 1 ;
- test point, enabling knowledge of the input and output state of each module.

At the closure module level, the reference markings enable :

- connection of loops A and B necessary for cycle repetition ;
- switching on of the sequencer ;
- fitting of a reset (RESET) if the application requires this.

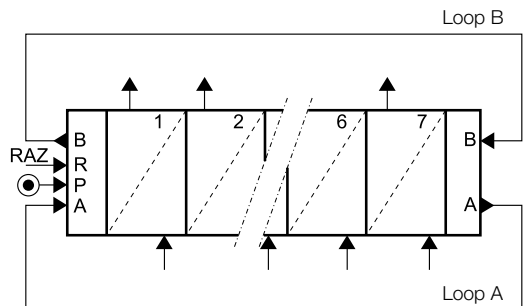
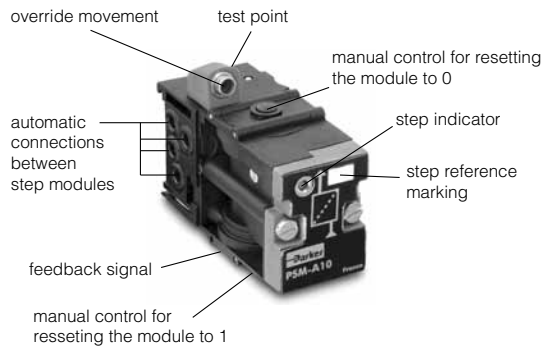

Setting up

The sequencer reproduces the GRAFCET function diagram configuration which defines the operating cycle : a sequencer stage module corresponds to each stage in the cycle.

The activated stage module sends the control signal to the pressure valve controlling the action intended for the stage, then waits for the feedback signal at the end of this action before activating the next stage module in the sequencer.

The all pneumatic loop shown in the diagram revolves in this way around the stage module, the sequencer activating stage by stage each of the actions to be carried out in the cycle order.

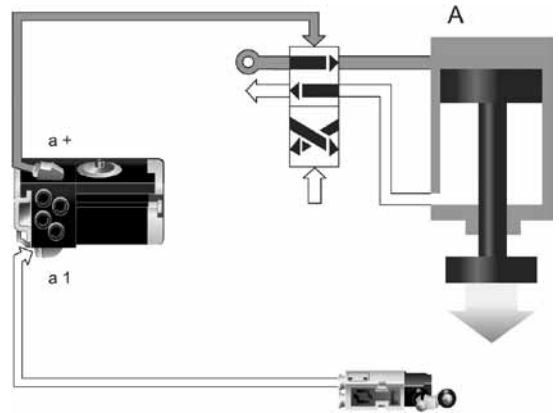

Example

This very simple example shows a pneumatic press fitted with a part supply cylinder.

A bistable power valve and end of travel sensors are associated with each cylinder.

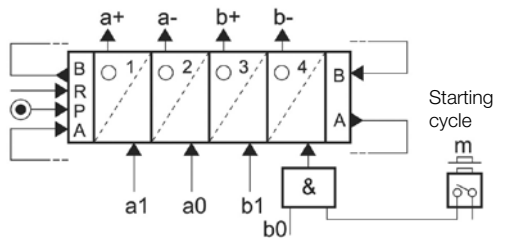
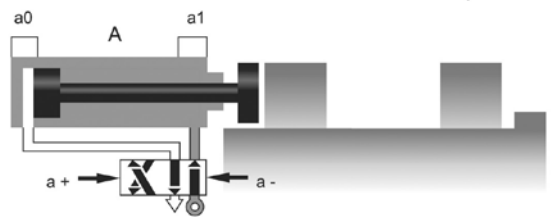
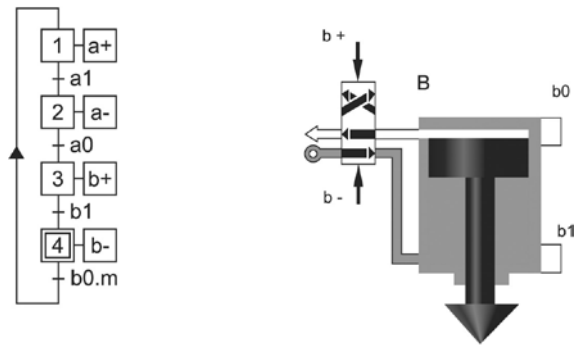

The GRAFCET diagram defines the required cycle. The initial stage is placed at the end to facilitate obtaining the cycle via the sequencer.

In the diagram, the sequencer reproduces the GRAFCET diagram, sending step by step control signals (a+, a-, b+, b-) according to the feedback signals (a1, a0, b1, b0).

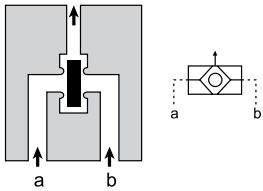
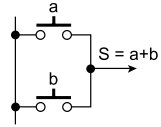

P

Basic features

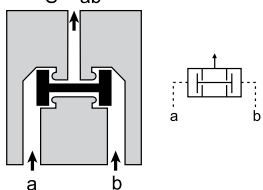
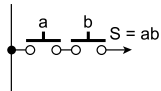
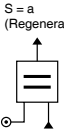
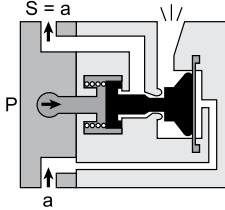
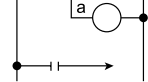
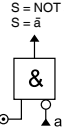
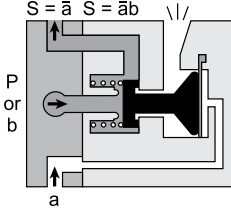
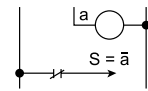
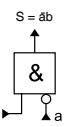
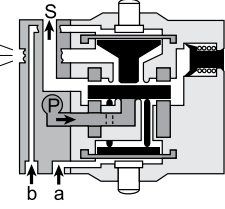
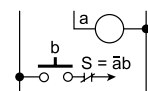
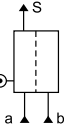
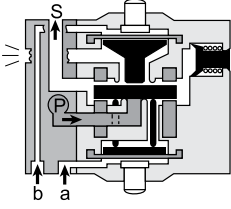
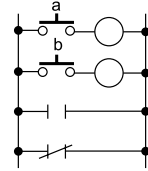
	Logic Function	Logic Symbol	Pneumatic Component	Function Symbol	Electrical Equivalent
P A S S I V E F U N C T I O N S	OR	$S = a \text{ OR } b$ (or both) $S = a + b$ 	Output S is ON if at least one of the inputs "a" OR "b" is ON.	$S = a + b$ 	
	AND	$S = a \text{ and } b$ $S = ab$ 	Output S is ON only if inputs "a" AND "b" are ON.	$S = ab$ 	
A C T I V E F U N C T I O N S	YES (Regenerate)	$S = a$ (Regenerated) 	Output S is ON and regenerated if input "a" is ON.	$S = a$ 	
	NOT (Inhibit)	$S = \text{NOT } a$ $S = \bar{a}$ 	Output S is ON if input "a" is OFF (and if supply P is present).	$S = \bar{a}$ $S = \bar{a}b$ 	
		$S = \bar{a}b$ 	"b" is an intermittent signal. "a" inhibits "b". Output S is ON if "b" is ON and "a" is OFF.		
MEMORY		Input "a" generates output S (SET). Output S remains ON until removed by input "b" (RESET).			

ATEX - Ex products compliance

Some products (**PLL-, PLK-, PLN-, PLJ-, PLM-, PRD-, PRF-, PRT-, PSM-, PSV-A1**) are available certified ATEX Labels II 2 GD c 85 °C zones 1, 2, 21, 22 certification n° LCIE 04 ATEX 6164X.

All these products are marked with * in this technical leaflet.

To obtain the ATEX version of the product, add -EX at the end of the order code Eg : **PSM-A12-EX**

For more information please refer to ATEX Components technical leaflet : PDE2584TCUK-ev

<p>Instruction Leaflet GB Logic elements </p> <p>1 – SPECIFICATIONS</p> <ul style="list-style-type: none"> • Operating temperature (Ta) -15°C to +60°C (5°F to +140°F) • Fluid temperature -15°C to +60°C (5°F to +140°F) • Operating pressure 3 to 8 bar (45 to 116 psi) • Air condition..... ISO 8573-1: - Filtered air or inert gas class 5 - Dry air or inert gas class 4 • Max Operating Frequency 5 Hz • Operating position Any position <p>2 – MODELS AND FUNCTIONS</p> <p>PLL-... / PLK-... / PLN-... / PLJ-C10 / PLM-... / ... Functions AND, OR, NOT, YES and Latch memory, PRD-... / PRF-... / PRT-... / ... Amplifier, Sensor, Timer, PSM-... / PSV-A12 Modular Sequencer.</p> <p>3 – INSTALLATION</p> <ul style="list-style-type: none"> • Mounting according to the PARKER catalogue, in conjunction with subbases and input modules: <p>PLE-B1 / PZU-... for functions and latch memory PZU-... for Amplifier, Sensor, Timer, PSE-A1 / PSD-... / PSB-A1. for Modular Sequencer</p> <p>WARNING</p> <ul style="list-style-type: none"> • Conditions for installing the components must comply with specifications mentioned in chapters 1 and 3 • Before maintenance operations, stop the air and ensure that pipes are exhausted. Then proceed. • The replacement of a component must be done with a component of the same ATEX category • Cleaning operations should be done by compliance with the specifications of the ATEX zone, preferably by aspiration and/or utilization of antistatic products. The deposit of dust should not exceed 5mm. • The installation and maintenance operations must be done by qualified personnel. <p>4 – ATEX CLASSIFICATION</p> <table border="1" style="width: 100%; border-collapse: collapse;"> <tr> <td style="width: 20px; text-align: center;"></td> <td>Specific logo for safety in hazardous atmospheres</td> </tr> <tr> <td style="text-align: center;">II</td> <td>Destination - Group II - Atmospheres other than in mines</td> </tr> <tr> <td style="text-align: center;">2</td> <td>For use in zones 1 and 21</td> </tr> <tr> <td style="text-align: center;">GD</td> <td>Gas or Dust atmospheres</td> </tr> <tr> <td style="text-align: center;">c</td> <td>Protection mode "c", constructional safety</td> </tr> <tr> <td style="text-align: center;">85°C</td> <td>Temperature class (T6)</td> </tr> </table> <p>The maximum ambient temperature (Ta) of the equipment or of the subassembly incorporating logic elements will be defined as:</p> <ul style="list-style-type: none"> • (Ta) of the element having the lowest limit if this one is < 60°C. • 60°C if elements other than the logic have a (Ta) > 60°C. 		Specific logo for safety in hazardous atmospheres	II	Destination - Group II - Atmospheres other than in mines	2	For use in zones 1 and 21	GD	Gas or Dust atmospheres	c	Protection mode "c", constructional safety	85°C	Temperature class (T6)	<p style="text-align: center;">EC DECLARATION of CONFORMITY </p> <p>We, Parker Hannifin France S.A.S. Etablissement d'Evreux Rue H. Becquerel – BP 3124 27031 EVREUX CEDEX – France</p> <p>herby declare that the following components from the Telepneumatic pneumatic logic range :</p> <ul style="list-style-type: none"> - PLL-... / PLK-... / PLN-... / PLJ-C10 / Functions AND, OR, NOT, YES, - PLM-... / PRD-... / PRF-... / PRT-... / Latch memory, Amplifier, Sensor, Timer, - PSM-... / PSV-A1. Modular Sequencer, <p>are compatible for use in explosive atmosphere II 2 GD (zones 1, 2 and 21,22).</p> <p>These components are designed and manufactured in compliance with the European Directive:</p> <ul style="list-style-type: none"> - 94/9/EC, March 1994, "ATEX" <p>The present declaration is based on the compliance with the following standards:</p> <ul style="list-style-type: none"> - Standard EN 13463-1, 2001 and AC:2002, Non-electrical equipment for potentially explosive atmospheres. Part 1: Basic methods and requirements - Standard EN 13463-5, 2003, Non-electrical equipment intended for use in potentially explosive atmospheres. Part 5: Protection by constructional safety "c". <p>Type certificate: LCIE 04 ATEX 6164X</p> <p>Delivered by: LCIE</p> <p>Additional information: These products are designed for utilization in applications falling under the scope of the ATEX Directive 94/9/EC. This coverage could only be referred to as long as operations for the installation and the maintenance of these products are complying with related standards. The user will have to comply with procedures for getting an approval of the final assembled system according to related regulations.</p> <p style="text-align: center;">Issued at Evreux Date: January 24th, 2007</p> <p>CE marked: 2004</p>
	Specific logo for safety in hazardous atmospheres												
II	Destination - Group II - Atmospheres other than in mines												
2	For use in zones 1 and 21												
GD	Gas or Dust atmospheres												
c	Protection mode "c", constructional safety												
85°C	Temperature class (T6)												

P

**Introduction to the European ATEX directive
Explosive atmospheres**

Directive 94/9/EC defines an explosive atmosphere as a mixture of :

- a) **flammable substances** – gases, vapours, mists or dusts
- b) with **air**
- c) under specific **atmospheric conditions**
- d) in which, after ignition has occurred, combustion spreads to the entire flammable mixture
(NB: with regard to dust, it may be that not all dust is combusted after ignition has occurred)

An atmosphere with the potential to become an explosive atmosphere during operating conditions and/or under the influence of the surroundings is defined as a **potentially explosive atmosphere**. Products covered by directive 94/9/EC are defined as intended for use in potentially explosive atmospheres.

Harmonised European ATEX standard

The European Union has adopted two harmonised directives in the field

of health and safety. The directives are known as ATEX 100a and ATEX 137.

Directive ATEX 100a (94/9/EC) lays down minimum safety requirements for products intended for use in potentially explosive atmospheres in European Union member states. Directive ATEX 137 (99/92/EC) defines minimum requirements for health and safety at the workplace, for working conditions and for the handling of products and materials in potentially explosive atmospheres. This directive also divides the workplace into **zones** and defines criteria by which products are **categorised** within these zones.

The table below describes the **zones** in an installation where there is a potential for explosive atmospheres. The **owner** of the installation must analyse and assess the area in which the explosive gas/dust mixture may occur, and if necessary must divide it into **zones**. This process of zoning then allows the correct plant and equipment to be selected for use in the area.

The ATEX directive has been in force throughout the European Union since 1 July 2003, replacing the existing divergent national and European

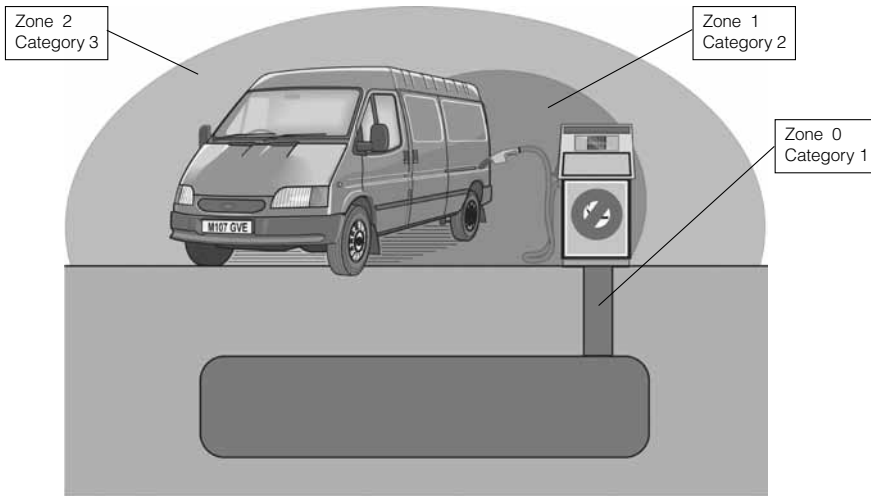

Zones		Presence of potentially explosive atmosphere	Type of risk
Gas G	Dust D		
0	20	Present continuously or for long periods.	Permanent.
1	21	Likely to occur in normal operation occasionally.	Potential.
2	22	Not likely to occur in normal operation but, if it does occur, will persist for a short period only.	Minimal.

legislation relating to explosive atmospheres. Please note that for the first time, the directive covers mechanical, hydraulic and pneumatic equipment and not just electrical equipment as before.

explosive atmospheres. The requirements in the Machinery directive are applicable to all other risks relating to machinery.

With regard to the **Machinery directive** 98/37/EC, note that a number of external requirements in 94/9/EC refer to hazards arising from potentially explosive atmospheres, where the Machinery directive only contains general requirements relating to explosion safety (Annex I 1.5.7). As a result, directive 94/9/EC (ATEX 100a) takes precedence over the Machinery directive with regard to explosion protection in potentially

In most cases full certification is not required, a much more simple "Risk Assessment" as detailed in the Directive, for the products to be supplied will suffice. At the moment we are conducting "Risk Assessments" in accordance with the Directive, on a broad range of core products which will be published on the web site. A more limited range of products will have the full ATEX certification where this is deemed necessary.

Levels of protection for the various equipment categories

The various equipment categories must be capable of operating in accordance with the manufacturer's operating specifications at defined levels of protection.

Definition of groups (EN 1127-1)

Group I Equipment intended for use in underground parts of mines as well as those parts of surface installations of such mines likely to be

Level of protection	Category		Type of protection	Operating specifications
	Group I	Group II		
Very high	M1		Two independent means of protection or safety, ensuring that the equipment remains functional even in the event of two faults occurring independently of each other.	The equipment remains energised and functional even with an explosive atmosphere present.
Very high		1	Two independent means of protection or safety, ensuring that the equipment remains functional even in the event of two faults occurring independently of each other.	The equipment remains energised and functional in zones 0, 1, 2 (G) and/or zones 20, 21, 22 (D).
High	M2		Protection suitable for normal operation and severe operating conditions.	The equipment is de-energised in the event of an explosive atmosphere.
High		2	Protection suitable for normal operation and frequent faults, or equipment in which faults normally have to be taken into account.	The equipment remains energised and functional in zones 1, 2 (G) and/or zones 21, 22 (D).
Normal		3	Protection suitable for normal operation.	The equipment remains energised and functional in zones 2 (G) and/or zones 22 (D).

dangered by flammable vapours and/or flammable dusts.

Group II Equipment intended for use in other places exposed to explosive atmospheres.

* G = gas and D = dust

Group	I mines, combustible vapours		II other potentially explosive atmospheres (gases, dust)					
	M1	M2	1		2		3	
Category								
Atmosphere*			G	D	G	D	G	D
Zone			0	20	1	21	2	22

Temperature classes

Classification of flammable gases and vapours on the basis of ignition temperature.

Declaration of conformity

Temperature class	Maxi. allowed temperature on the surface of the material (°C)
T1	450
T2	300
T3	200
T4	135
T5	100
T6	85

Parker components out of scope of the ATEX Directive :

Essential elements with the reliable use of the products and protection systems, but not having an autonomous function nor an own ignition source.

The product catalogues contain copies of the declaration of conformity demonstrating that the product meets the requirements of directive 94/9/EC.

The declaration is only valid in conjunction with the instructions contained in the installation manual relating to the safe use of the product throughout its service life.

The instructions relating to the conditions in the surrounding area are particularly important, as the certificate is invalidated if the instructions are found not to have been adhered to during operation of the product. If there is any doubt as to the validity of the certificate of conformity, contact Parker Hannifin customer service.

Operation, installation and maintenance

The product installation manual contains instructions relating to the safe

storage, handling, operation and servicing of the product.

The manual is available in different languages, and can be downloaded from www.parker.com/euro_pneumatic.

This document must be made accessible in a suitable place near where the product is installed. It is used as a reference for all personnel authorised to work with the product throughout its service life.

We, the manufacturer, reserve the right to modify, extend or improve the installation manual in the interests of the users.

For more information about ATEX see EUs homepage: <http://europa.eu.int/comm/enterprise/atex/>

Pneumatic automation; Control module

**Time delay
Relay**

**Relay
function**



Series	PSM, PLM	PLL, PLK	PLL, PLK	PLN ^D _C , PLJ	PRT	PLM
Function	Modular sequencer	Stand alone logic cell	Stackable logic cell	Subbase mtd logic cell	Time relay Pneum. Relay	Memory Relay
Operating Pressure	3 to 8 bar	3 to 8 bar	3 to 8 bar	3 to 8 bar	3 to 8 bar	3 to 8 bar
Storage temperature	-15 °C to +70 °C	-15 °C to +70 °C	-15 °C to +70 °C	-15 °C to +70 °C	-15 °C to +70 °C	-15 °C to +70 °C
Working temperature	-40 °C to +60 °C	-40 °C to +60 °C	-40 °C to +60 °C	-40 °C to +60 °C	-40 °C to +60 °C	-40 °C to +60 °C
Flow, NI/min at 6 bar	180	180	180	90/180	180	180
Flow, Kv	1,8	1,8	1,8	1/1,8	1,8	1,8
Response time	Commuting time of the primary acting cell: 2 to 3 ms					
Mechanical life at 6 bar, 20 °C 1 Hz	10 million cycles	100 million cycles	100 million cycles	10 million cycles	10 million cycles	10 million cycles
Shocks and Vibrations	According to IEC 68-2-6 and IEC 68-2-27					
Connection	Push-in connection Ø4 mm					
Mounting	All positions	All positions	All positions	All positions	All positions	All positions
Refer to page	15	16	17	17	18	19

P

Material

Valve member - seat : Self lubricating acetal - ceramic
 Body : Polyamide reinforced fibreglass
 Casing - End plates : Anodised aluminium
 Valve plate : Zamak
 Seals : Nitrile
 Springs : Stainless steel
 Screws : Stainless steel
 Poppets : Polyuréthane

General Characteristics

Fluid : Air or inert gas
 filtered 40 µ class 5 according to ISO 8573-1
 dry class according to service temperature
 non-lubricated, or lubricated
 Storage temperature : -40 °C to + 70 °C
 Low temperature climatic : According to EN 60068-2-1, test Ad
 High temperature climatic : According to EN 60068-2-2, test Bd
 Shock and Vibrations : According to IEC 68-2-6 and IEC 68-2-27
 Salt spray test : According to ISO 9227, 168 h
 Solenoid orifice : 1.2/1.3mm
 Power (DC) : 6 to 6.8W
 Voltage tolerance : +/- 30%
 Duty cycle : 100%
 Electrical connection : Din A

Relay functions	Pressure Switch	Solenoid Actuator	Counters and Timers			
------------------------	------------------------	--------------------------	----------------------------	--	--	--

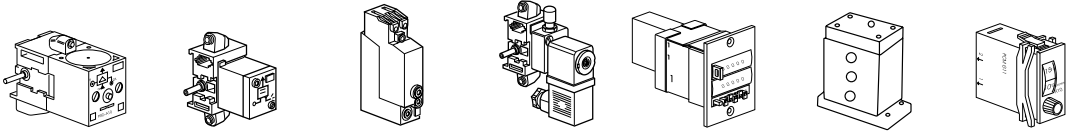

PRD	PRF	PRE, PS1	PRS	PCT, PCP	2147	PCM
Amplifier relay	Sensor relay	Pressure switch	Solenoid actuator	Counter	Binary Counter	Timers
3 to 8 bar	3 to 8 bar	3 to 8 bar	3 to 8 bar	2 to 8 bar	0 to 10 bar	2 to 6 bar
-15 °C to +70 °C	-15 °C to +70 °C	-15 °C to +70 °C	-15 °C to +70 °C	0 °C to +60 °C	0 °C to +70 °C	0 °C to +60 °C
-40 °C to +60 °C	-40 °C to +60 °C	-40 °C to +60 °C	-40 °C to +40 °C	-0 °C to +50 °C		-0 °C to +60 °C
90	180	-	60	-	460	100
1	1,8		0,65	-	-	
Commuting time of the primary acting cell: 2 to 3 ms		2 to 3 ms	8 to 12 ms	Reset time 150 ms	Reset time 200 ms	
10 million cycles	10 million cycles	10 million cycles	10 million cycles	10 million cycles	50 million cycles	5 million cycles

According to IEC 68-2-6 and IEC 68-2-27

Push-in connection Ø4 mm

All positions	All positions	All positions	All positions	All positions	All positions	All positions
19	19	20	20	21	21	21

P

Specific characteristics

PRD

Signal pressure (a) : 0,5 to 2 mbar (maximum permissible overpressure = 200 mbar)
 Auxiliary supply pressure (p) : 100 to 200 mbar
 Consumption : at 100 mbar with a = 0 : 3l/min ANR
 Operating frequency : 10 Hz (with manual control)

PRF

Operating pressure : 3 to 8 bar
 Nozzle Ø : 0,3 mm
 Nozzle consumption : 2 Nl/min per bar

PRS

Consumption : Direct current : sealed = 5 W Alternating current : sealed= 6 VA ; inrush = 20 VA
 Voltage range : 0,9 to 1,05 Un
 Standard voltages : 24 VDC ; 48 VDC ; 24 VAC ; 115 VAC ; 230 VAC
 Rating : 100 %
 Connection : Plug -in connector, Ø 9 mm cable entry, terminal capacity 1,5 mm²
 Nominal insulation voltage : 660 V AC or V DC (with manual control)
 Protection degree : IP 65



PRE

Trip pressure : 2,2 to 3 bar
 Depilot pressure : 2 to 2,6 bar
 Max. operating frequency : 10 Hz
 Nominal insulation voltage : 660 V AC or V DC
 Nominal thermal rating : 10 A
 Protection degree : IP 65
 Connection : Plug -in connector, Ø 9 mm cable entry, terminal capacity 1,5 mm²
 Function : NO contact

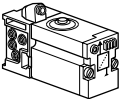

P**PS1-P**

Fixed trip pressure : ≤1,3 bar
 Adjustable trip pressure : 2 to 5 bar
 Nominal thermal rating : 10 A
 Max. operating frequency : 10 Hz
 Nominal insulation voltage : 660 V AC or V DC
 Protection degree : IP 40
 Function : Open/Closed contact

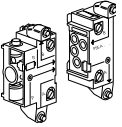

Step modules

Type	Symbol	Logic function	Description	Connection	Weight kg	Order code
		Visual indication of pneumatic output and manual override	With PSB-A12 sub-base	Ø4 mm Swivel push-in	0,175	PSM-A12 *
		Without manual override	With PSB-A12 sub-base	Ø4 mm Swivel push-in	0,170	PSM-B12 *

Set of head and tail modules

Type	Symbol	Logic function	Connection	Weight kg	Order code
		Ø6 mm Swivel push-in connection	Ø4 mm Swivel push-in	0,080	PSE-A12

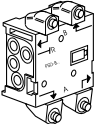

Deviation modules

Type	Symbol	Logic function	Connection	Weight kg	Order code
		Used for parallel, optional, repeat sequenses and skip step	Ø4 mm Swivel push-in	0,050	PSD-A12
		for the remote reset of the last step module		0,050	PSD-B12

* ATEX version available Order code example : **PSM-A12-EX**

 Indicates stocked product.

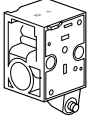

Additional step module interlock

Type	Symbol	Logic function	Connection ⁽¹⁾ connection	Weight kg	Order code
		May be mounted between the sub-base and the step module to interrupt the sequence if a sensor is found to be faulty	Ø4 mm Swivel push-in	0,045	PSV-A12 *

(1) For other type of connections contact Technical Sales Department

Step module without sub-base

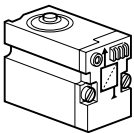
To be used with PSB-A12 sub-bases



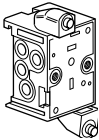

Type	Symbol	Logic function	Description	Weight kg	Order code
		Visual indication of pneumatic output	With manual override	0,135	PSM-A10 *
			Without manual override	0,130	PSM-B10

Step module sub-base

Type	Description	Connection ⁽¹⁾	Weight kg	Order code
	Sub-base	Ø4 mm Swivel push-in	0,040	PSB-A12

(1) For other type of connections contact technical sales Technical Sales Department







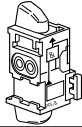

Main data for Line mounted elements

Type	Symbol	Logic function	Description	Connection	Weight kg	Order code
		AND	Single module	Ø4 mm Straight push-in	0,07	PLL-A11 *
		OR	Single module	Ø4 mm Straight push-in	0,07	PLK-A11 *
		Screw and clip assembly	Enables line mounted logic elements to be attached to DIN rail (Sold per pack of 10)		0,02	PZM-L199

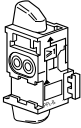
* ATEX version available Order code example : **PSV-A12-EX**

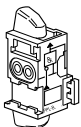

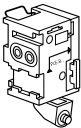







 Indicates stocked product.

Main data for Combinable elements

Type	Symbol	Logic function	Description	Connection (1)	Weight kg	Order code
		AND	With built-in key for combination and operating mode selection	Ø4mm Swivel push-in	0,08	PLL-B12 *
		OR	With built-in key for combination and operating mode selection	Ø4mm Swivel push-in	0,08	PLK-B12 *
		NOT	With built-in key for combination and operating mode selection	Ø4mm Swivel push-in	0,08	PLN-B12 *
		INPUT	With built-in key for combination, clip for mounting on DIN rail and blanking plate for closing a bank of combined elements	Ø4mm swivel push-in	0,08	PLE-B12

(1) For other type of connections contact Technical Sales Department

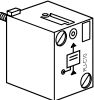



Main data for Sub-base mounted element

Type	Symbol function	Logic	Description	Weight kg	Order code
		AND	With visual indication of pneumatic output signal	0,03	PLL-C10 *
		OR	With visual indication of pneumatic output signal	0,03	PLK-C10 *
		NOT inhibit standard	With visual indication of pneumatic input/output signal	0,03	PLN-C10 *
		NOT inhibit	With visual indication of pneumatic input/output signal threshold	0,03	PLN-D10 *
		YES regenerate	With visual indication of pneumatic input/output signal	0,03	PLJ-C10 *

 Indicates stocked product.

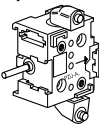
* ATEX version available Order code example : **PLL-B12-EX**

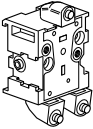

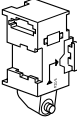
Sub base mounted elements

Type	Symbol	Logic function	Description	Connection ⁽¹⁾	Weight kg	Order code
3-port sub-bases (2) 	 		With common input	Ø4 mm Swivel push-in	0,04	PZU-A12
			Cascade	Ø4 mm Swivel push-in	0,05	PZU-C12
4-port sub-bases (2) 			For combination with memory relay (see next page) and amplifier relay (see next page)	Ø4 mm Swivel push-in	0,05	PZU-B12
Input module 				Ø4 mm Swivel push-in	0,05	PZU-E12

(1) For other type of connections contact Technical Sales Department (Ex : M5 connection = PZU-E15)

(2) Can be used singly or in combination. Mounting methods: On DIN rail with built in clip, on surface mounting using screws M4x25

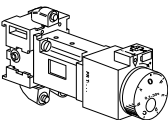
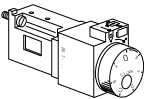
Main data for time delay relays

Type	Function	Timing range	Connection ⁽¹⁾	Weight kg	Order code
Complete with sub-base PZU-A12 	Output after timed period	0,1 to 30 s	Ø4 mm Swivel push-in	0,17	PRT-A12 *
Without sub-base For sub-base PZU-A12 or PZU-C12 	 	Output after timed period	0,1 to 3 s	0,13	PRT-E10 *
			0,1 to 30 s	0,13	PRT-A10 *
			10 to 180 s	0,13	PRT-B10 *
	Output during timed period (3)	0,1 to 3 s	0,13	0,13	PRT-F10 *
		0,1 to 30 s	0,13	0,13	PRT-C10 *
		10 to 180 s	0,13	0,13	PRT-D10 *
Tamper proof cap				0,01	LA9-D901



* ATEX version available Order code example : **PZU-A12-EX**

(1) For other type of connections contact Technical Sales Department



(3) Can be used to provide an impulse generator

 Indicates stocked product.



Main data for Memory relays

Type	Symbol	Description	Connection ⁽¹⁾	Weight kg	Order code
Complete with sub-base PZU-B12		With priority reset signal and visula indication With manual override	Ø4 mm Swivel push-in	0,19	PLM-A12 *
Without sub-base For sub-base PZU-B12		With priority reset signal and visual indication With manual override		0,14	PLM-A10 *
		Without manual override		0,13	PLM-B10

Main data for Amplifier relays

Type	Symbol	Description	Connection ⁽¹⁾	Weight kg	Order code
Complete with sub-base PZU-B12		This relay is used to amplify the low pressure signal provided by a fluidic proximity sensor to a useable level With manual override	Ø4 mm Swivel push-in	0,18	PRD-A12 *
Without sub-base For sub-base PZU-B12		This relay is used to amplify the low pressure signal provided by a fluidic proximity sensor to a useable level With manual override		0,13	PRD-A10 *

Main data for Sensor relays

Type	Symbol	Description	Connection ⁽¹⁾	Weight kg	Order code
Complete with sub-base PZU-A12		This relay is used to provide a supply to a bleed sensor and to generate a pneumatic signal equal to its supply pressure	Ø4 mm Swivel push-in	0,07	PRF-A12 *
Without sub-base For sub-base PZU-A12 or PZU-C12		This relay is used to provide a supply to a bleed sensor and to generate a pneumatic signal equal to its supply pressure		0,03	PRF-A10 *



* ATEX version available Order code example : **PLM-A12-EX**

(1) For other type of connections contact your Technical Sales Department

 Indicates stocked product.

P

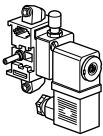

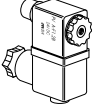



Main data for Solenoid actuators

Type	Symbol	Voltage	Load	Connection	Weight kg	Order code
Complete units, solenoid and cable plug						
		24 V ~ 50/60 Hz	8,5 VA	Manual override	22 mm Plug-in	0,17 PRS-A121B
		24 V	6 W	Manual override	22 mm Plug-in	0,17 PRS-A122B
		115 V ~ 50 Hz 120 V ~ 60 Hz	8,5 VA	Manual override	22 mm Plug-in	0,17 PRS-A121F
		230 V ~ 50 Hz 240 V ~ 60 Hz	8,5 VA	Manual override	22 mm Plug-in	0,17 PRS-A121M
Solenoid mounting base						
		For mounting the solenoid coil and plunger on 3-port modular sub-bases type PZU-A••, see page 18		Manual override	0,09	PRS-D10
Solenoid coil with plunger and 22 mm plug-in connector (4)						
		24 V*	6 W			0,135 PVA-F102B
		48 V*	6 W			0,135 PVA-F102E
		24 VAC 50/60 Hz	8,5 VA			0,135 PVA-F101B
		48 VAC 50/60 Hz	8,5 VA			0,135 PVA-F101E
		115 VAC 50 Hz/ 120 VAC 60 Hz	8,5 VA			0,135 PVA-F101F
		230 VAC 50 Hz 240 VAC 60 Hz	8,5 VA			0,135 PVA-F101M
		255 VAC 50 Hz	8,5 VA			0,135 PVA-F101U

* Versions available for operation in explosive atmospheres.
 - Conforming to certificate LCIE 866115X
 - Electrical equipment conforming to harmonised European standards



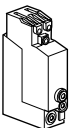

EN 50014 dated March 1977 (NFC 23514 dated May 1982)
 EN 50019 dated March 1977 (NFC 23519 dated May 1982)
 - Referencing code EExe II T4 (consult Technical Sales Department)
 (4) Can be fitted with LED indicator and suppression, PVA•ZF••

Main data for Pressure switches

Type	Symbol	Electrical characteristics	Pneumatic characteristics	Connection Electric/Pneumatic	Weight kg	Order code
Complete unit with sub-base, solenoid and cable plug						
		N/O contact	Manual override	22 mm Plug-in	0,13	PRE-A12
				Ø4 mm Swivel push-in		
Without sub-base						
		N/O contact	Manual override	22 mm Plug-in	0,04	PRE-A10
				Ø4 mm Swivel push-in		
Line mounted						
		1 CO contact 5 A/250 V	Fixed operating threshold	Manual override	Ø4 mm Push-in	0,05 PS1-P1081
		1 CO contact 5 A/250 V	Adjustable operating threshold	Manual override	Ø4 mm Push-in	0,05 PS1-P1091

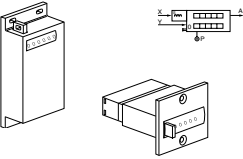
 Indicates stocked product.

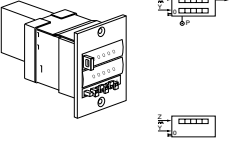

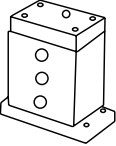

Main data for Impulse counters

Type	Symbol	Type	Counting range	Mounting	Weight kg	Order code
Totalling counters						
		Pneumatic or manual reset	0 - 999 999	Surface mounting	0,08	PCT-A11
				Flush mounting	0,06	PCT-B11
Pre-selection counters						
		Additional with pneumatic or manual reset	0 - 99 999	Flush mounting	0,12	PCP-A11
		Auto reset	0 - 99 999	Flush mounting		PCP-A111
		Subtraction with pneumatic or manual reset	0 - 99 999	Flush mounting	0,11	PCP-S11

Binary counters

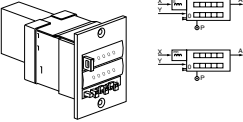
Type	Description	Weight kg	Order code
	Pneumatic actuated	0,650	2147900
	Electrical actuated	0,775	2147950

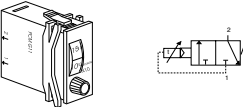
Main data for Timers



Type	Symbol	Type	Time base	Time range	Weight kg	Order code	
Digital display							
		With pneumatic or manual reset	1 second	1 second to 27 hours	0,20	PCM-A11	
				1 minute	1 minute to 69 days	0,20	PCM-B11
				2 minutes	3 to 100 minutes	0,20	PCM-E11
Calibrated dial							
			1 second	2 to 30 seconds	0,05	PCM-F11	
			1 second	20 to 300 seconds	0,05	PCM-G11	

 Indicates stocked product.

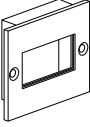
Mounting bezels

Type	Description	Weight kg	Order code
	For PCM-F11 and PCM-G11 mounting in 60 x 75 mm cut-out	0,015	PXC-ZM6075
	For PCM-F11 and PCM-G11 mounting in 72 x 72 mm cut-out	0,015	PXC-ZM7272

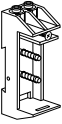
Bezels for DIN rail mounting

Type	Description	Weight kg	Order code
	For (non-reversible) clip-on mounting of PCM-F11 and PCM-G11 on push-in connection sub-base	0,020	PXC-ZA35
	35 mm DIN rail latching device for PXC-ZA35 sub-bases	0,010	PXC-ZE35

Lockable cover

Degree of protection IP 55

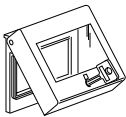
Type	Description	Weight kg	Order code
	Transparent cover key lockable for 60x75 bezel for PCP-A11, PCP-S11, PCP-MA11, PCP-MB11	0,025	PXC-B1
	For PCT-B11	0,018	PXC-A1

P

 Indicates stocked product.

Seals for step modules and additional interlock modules

Type	Base component	Weight kg	Order code
1 set of 10 flat seals	PSM-A12 PSM-B12 PSV-A12 PSB-A12	0,038	PPR-L01

For logic elements and relays for mounting on modular sub-bases

Type	Base component	Weight kg	Order code
1 lot of 100 O-ring seals comprising : - 10 seals for ports with inputs filters - 90 seals for ports without input filter	PLJ-C10 PLK-C10 PLL-C10 PLN-C10 PLN-D10 PRT- . . PRF-A10	0,015	PPR-L04

For amplifier relays

Type	Base component	Weight kg	Order code
1 lot of 10 Mylar diaphragms	PRD-A10 PRD-A12	0,004	PPR-L08



Base usage - Shows which components can be mounted with which base types

Element	Order code	Type	2-Port	3-Port	4-Port	6-Port
		Stacking		PZU-A12	PZU-B12	PSA-B12
		Stacking		PZU-C12		
		Inline	BNC3P20	BNC3P10		
		Inline	BPB3P20	BPB3P10		
Step Module						
Step Module with Overrides	PSM-A10					X
Step Module without Override	PSM-B10					X
Logic						
AND	PLL-C10			X		
OR	PLK-C10			X		
YES	PLJ-C10			X		
NO	PLN-C10			X		
Threshold NOT	PLN-D10			X		
Relays						
Sensor	PRF-A10			X		
Solenoid	PRS-A10		X	X		
Electric Pressure Switch	PRE-A10			X	X	
E/P Pressure Switch	LNOTPS10			X		
Electric Pressure switch	LPS10		X	X		
Vacuum / Electric	LPSV10		X	X		
Timers						
Timer (NNP) Relay	PRT-A10		X*	X		
Timer (NNP) Relay	PRT-B10		X*	X		
Timer (NNP) Relay	PRT-E10		X*	X		
Timer (NNP) Relay	PRT-C10		X*	X		
Timer (NNP) Relay	PRT-D10		X*	X		
Timer (NNP) Relay	PRT-F10		X*	X		
Other Relays						
Memory Relay	PLM-A10			X	X	
Amplifier Relay	PRD-A10			X	X	

* Functionality must be checked.

Fitting color code

Port	Label		Color
Supply	P	2	Black / None
Signal	a	1	Green
Output	S	3	Red

Sequencer input power modules

	Entry Module	Head / Tail
Used with Base	PZU-E12	PSE-A12 *
	PZU-A12	PSB-A12 **
	PZU-C12	
	PZU-B12	

* PSE-A12-**EX** (ATEX version)

* PSE-A127 (U.S. version)

** PSB-A12-**EX** (ATEX version)



Dimensions, Logic processing

Modular sequencer

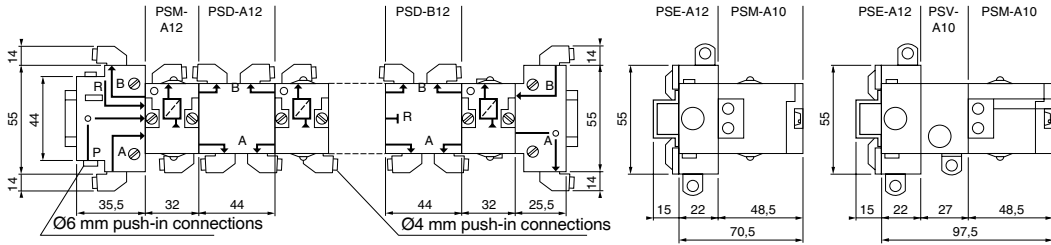

Line mounted logic elements

PLL-A11 and PLK-A11

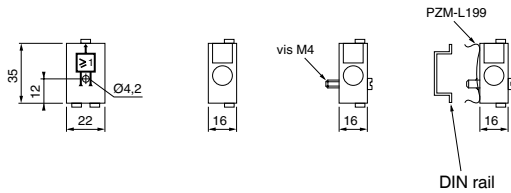

Combinable logic elements

PLE-B12 – PLL-B12 – PLK-B12 and PLN-B12

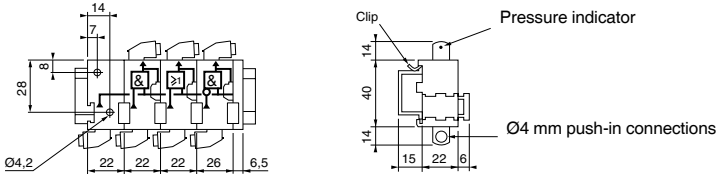

P

Logic elements mounted on 3-port modular sub-bases

PZU-E12

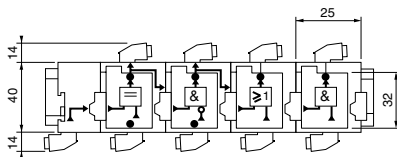

PLJ-C10 – PLN-C10 – PLK-C10 and PLL-C10 mounted on PZU-C12 and PZU-A12

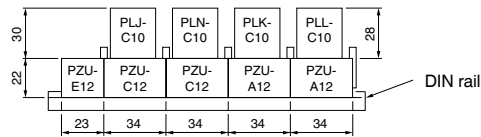

3 and 4-port modular sub-bases
PZU-E12 – PZU-C12 – PZU-A12

PZU-B12

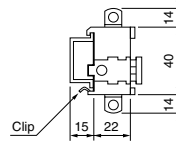
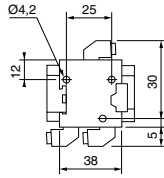
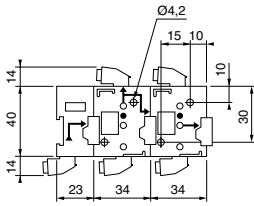

Relays mounted on 3-port modular sub-bases
PRT-A12 – PRF-A12 – PRE-A12 – PRS-A121 and PLN-D12

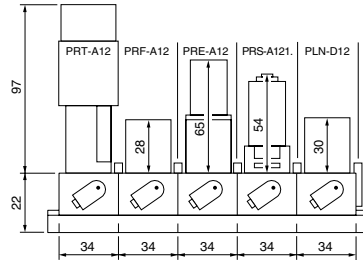
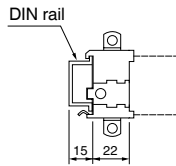
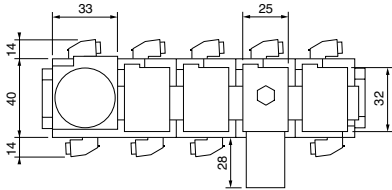

Relays mounted on 4-port modular sub-bases
PLM-A12 and PRD-A12

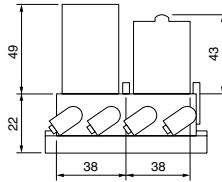
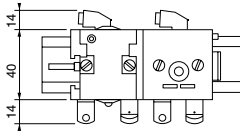

Pressure switch
PS1-P1091

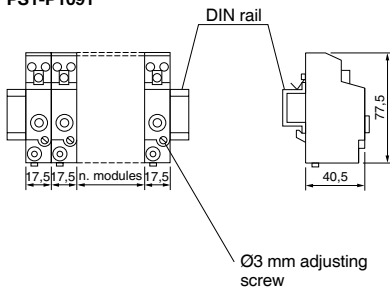

Totalling counters

PCT-A11 PCT-B11

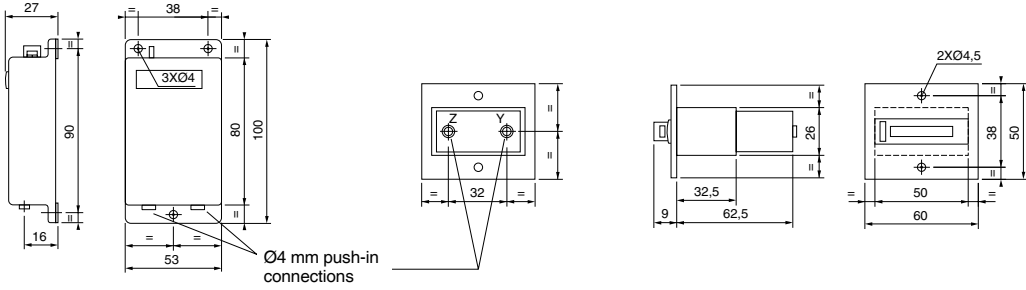

Preselection counters

PCP-A11 and PCP-S11

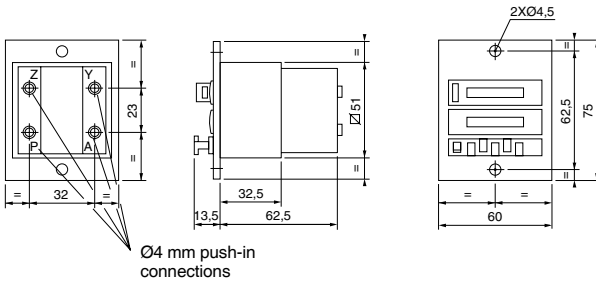

Binary counters

PCM-A11 and PCM-B11

2147900

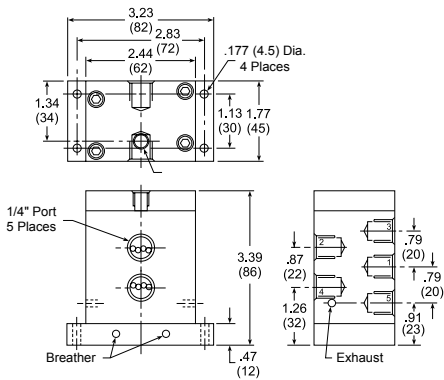

2147950

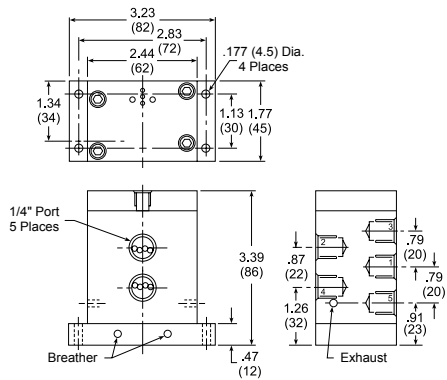

Digital display timers
PCM-A11 and PCM-B11

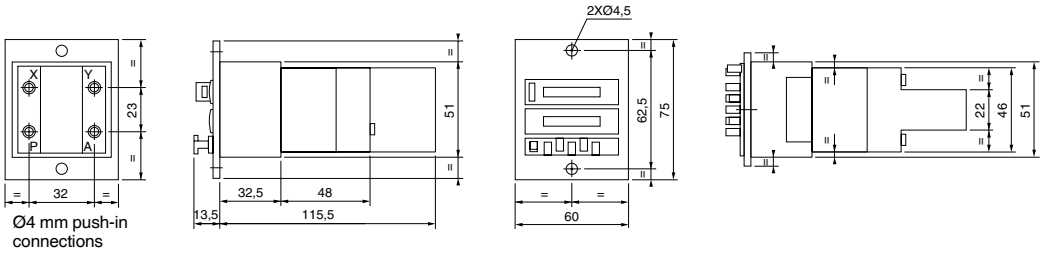

Timers with calibrated dial
PCM-F11 and PCM-G11

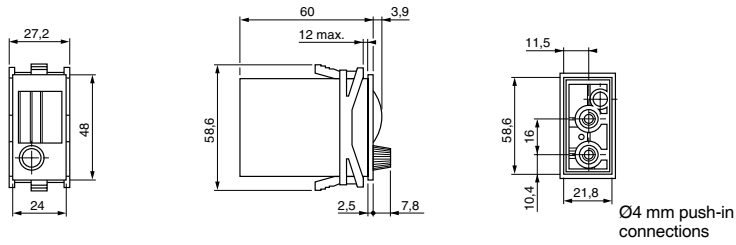

P

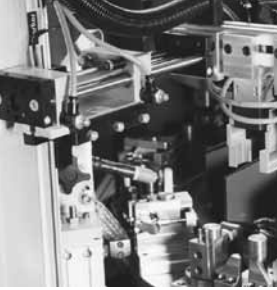

Man/Machine Dialogue

Push-buttons, Two hand control units

- Facia mounted operator
- 3/2 NO or NC
- Pneumatic valves combinable with electrical switches
- Modular construction (up to 3 valves per pushbuttons heads)
- Wide range of actuators



Operating and additional information

Working pressure

PXB-B3••

1 to 9 bar

PXB-B4••

1 to 10 bar

Working temperature

-15 °C to +60 °C

Flow

(acc. to ISO 6358)

PXB-B3••

Qmax=60 NI/min

Qn = 30 NI/min

PXB-B4••

Qmax=240 NI/min

Qn = 120 NI/min

Connections

Ø4 mm straight Push-in as standard

Ø4 mm swivel Push-in on request

M5 on request

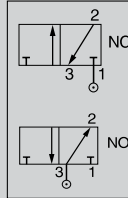

All PXB-B4 valves can be connected either as normally closed 3/2 valve (NC) or normally open 3/2 valve (NO) as required, by connecting the primary air supply to port 1 or port 3.





Spring return pushbuttons - Metal head version - Ø 4 mm straight fittings

Symbol	Actuator	Return	Operating force at 6 bar, N	Flow NI/min	Weight kg	Order code
	Pushbutton Black	Spring	8,5 6,0	60 240	0,077 0,082	PXB-B3111BA2 PXB-B4131BA2
	Pushbutton Green	Spring	8,5 6,0	60 240	0,077 0,082	PXB-B3111BA3 PXB-B4131BA3
	Pushbutton Red	Spring	8,5 6,0	60 240	0,077 0,082	PXB-B3111BA4 PXB-B4131BA4
	Pushbutton Black	Spring	16,5 14,0	60 240	0,087 0,092	PXB-B3251BA2 PXB-B4231BA2

Mushroom head pushbuttons - Metal head version - Ø 4 mm straight fittings

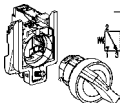

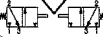
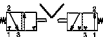
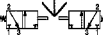
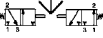

Symbol	Actuator	Return	Operating force at 6 bar, N	Flow NI/min	Weight kg	Order code
	Pushbutton Ø40 mm Black	Spring	12 6,5	60 240	0,122 0,127	PXB-B3111BC2 PXB-B4131BC2
	Latching pushbutton Ø40 mm Red		48 42,5	60 240	0,125 0,127	PXB-B3111BT4 PXB-B4131BT4
	Latching pushbutton Ø40 mm Red		49 43,5	60 240	0,125 0,127	PXB-B3121BT4 PXB-B4131BT4

Selector switches - Metal head version - Ø 4 mm straight fittings

Symbol	Actuator	Return	Flow Nl/min	Weight kg	Order code
	 Latching selector button 2 positions, Black		60	0,092	PXB-B3111BD2
			240	0,097	PXB-B4131BD2
	 Latching selector button 2 positions, Black		60	0,102	PXB-B3211BD2
			240	0,107	PXB-B4231BD2
	 Latching selector button 3 positions, Black		60	0,102	PXB-B3251BD2
			240	0,107	PXB-B4231BD2
 Latching selector button 3 positions, Black		60	0,102	PXB-B3211BD3	
		240	0,107	PXB-B4231BD3	
 Latching selector button 3 positions, Black		60	0,102	PXB-B3251BD3	
		240	0,107	PXB-B4231BD3	
 Non latching selector button with long handle 3 positions, Black	Spring		60	0,103	PXB-B3211BJ5
			240	0,108	PXB-B4231BJ5









Switch bodies with operating metal head mounting - Ø 4 mm straight fittings

For use with ZB4 operating heads



Symbol	Actuator	Return	Operating force at 6 bar, N	Flow Nl/min	Weight kg	Order code
	 Plunger	Spring	7	60	0,048	PXB-B3111B
			4,5	240	0,053	PXB-B4131B
	 Plunger	Spring	8	60	0,048	PXB-B3121B
			4,5	240	0,053	PXB-B4131B

Additional switch valves - Ø 4 mm straight fittings

For use with ZB4 and ZB5 operating heads and mounting blocks

Symbol	Actuator	Return	Operating force at 6 bar, N	Flow Nl/min	Weight kg	Order code
	 Plunger Straight connection	Spring	7	60	0,010	PXB-B3911
			4,5	240	0,015	PXB-B4931
	 Plunger Straight connection	Spring	8	60	0,010	PXB-B3921
			4,5	240	0,015	PXB-B4931
	 Plunger Swivel connection	Spring	7	60	0,015	PXB-B3912
			4,5	240	0,021	PXB-B4932
	 Plunger Swivel connection	Spring	8	60	0,015	PXB-B3922
			4,5	240	0,021	PXB-B4932

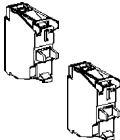
Electrical contact blocks

Connections	Type of contact	Weight kg	Order code
	Normally open (NO) 	0,011	ZBE-101
	Normally closed (NC) 	0,011	ZBE-102

Mounting block for valves and operating heads

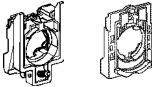
Description	For Metal head ZB4		For Plastic head ZB5	
	Weight kg	Order code	Weight kg	Order code
 <p>Mounting block for valves and operating heads:</p> <p>to make up a complete push button with one operating head and switch valves.</p>	0,038	ZB4-BZ009	0,006	ZB5-AZ009

Operating heads

For use with PXB-B3. and PXB-B4. switch bodies

Spring return pushbuttons

Description	Colour	Weight kg	Metal head		Plastic Head	
			Order code	Weight kg	Order code	
 <p>Flush</p>	Black	0,029	ZB4-BA2	0,018	ZB5-AA2	
	Green	0,029	ZB4-BA3	0,018	ZB5-AA3	
	Red	0,029	ZB4-BA4	0,018	ZB5-AA4	
	6 color caps	0,029	ZB4-BA9	0,018	ZB5-AA9	
 <p>Projecting</p>	Black	0,030	ZB4-BL2	0,019	ZB5-AL2	
	Green	0,030	ZB4-BL3	0,019	ZB5-AL3	
	Red	0,030	ZB4-BL4	0,019	ZB5-AL4	
 <p>Flush booted</p>	Black	0,034	ZB4-BP2			





Push/push pushbuttons

Description	Colour	Weight kg	Metal head	
			Order code	
 <p>Flush</p>	Black	0,029	ZB4-BH02	
	Green	0,029	ZB4-BH03	
	Red	0,029	ZB4-BH04	



Double headed spring return pushbuttons

Description	Colour Marking	Weight kg	Metal head Order code
 <p>Flush</p>	Green/Red I/O	0,047	ZB4-BA8234

Mushroom head pushbuttons

Description	Function	Colour	Metal head		Plastic Head	
			Weight kg	Order code	Weight kg	Order code
 <p>Ø40 mm</p> <p>Mushroom head</p>	Spring return	Black	0,074	ZB4-BC2		
		Green	0,074	ZB4-BC3		
		Red	0,074	ZB4-BC4		
 <p>Latching push-pull</p>	Red		0,077	ZB4-BT4		
 <p>Ø60 mm</p> <p>Mushroom head</p>	Spring return	Black	0,093	ZB4-BR2		
 <p>Ø40 mm</p> <p>Mushroom head</p>	Latching Turn to release	Red	0,070	ZB4-BS54	0,044	ZB5-AS54
	Latching Release by Ronis key N°455	Red	0,070	ZB4-BS14		

Selector switches

	Description	Function	Weight kg	Metal head Order code	Weight kg	Plastic Head Order code
	Standard, black handle	2 positions Stay put	0,044	ZB4-BD2	0,024	ZB5-AD2
		3 positions Stay put	0,044	ZB4-BD3	0,024	ZB5-AD3
		3 spring return to centre	0,044	ZB4-BD5	0,024	ZB5-AD5
	Long black handle	2 positions Stay put	0,045	ZB4-BJ2		
		3 positions Stay put	0,045	ZB4-BJ3		
		Spring return to centre	0,045	ZB4-BJ5		
		1 spring return from left to centre	0,045	ZB4-BJ7		

	Description	Function with drawal	Key	Weight kg	Order code
	Key operated (Ronis key N° 455)	2 stay put positions	Left	0,069	ZB4-BG2
			Left and right	0,069	ZB4-BG4

Tools

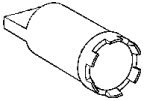
	Description	Weight kg	Order code
	ZB5 head nut tool	0,160	ZB5-AZ905

Dimensions

PXB-B3

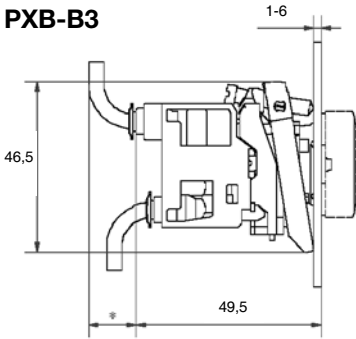

Body width 30 mm
 * With 2 x 4 mm tube = 10
 With 2,7 x 4 mm tube = 15

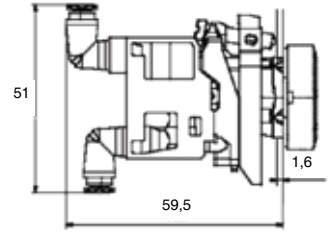
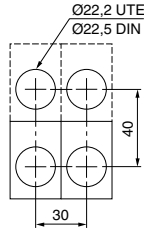

PXB-B4

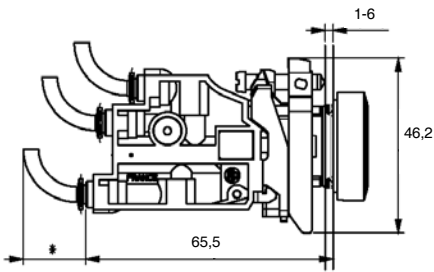

Body width 30 mm
 * With 2 x 4 mm tube = 10
 With 2,7 x 4 mm tube = 15

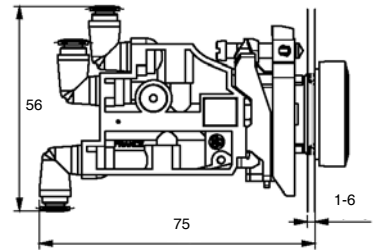

Assembling of PXB-B3. and PXB-B4. valves on mounting block

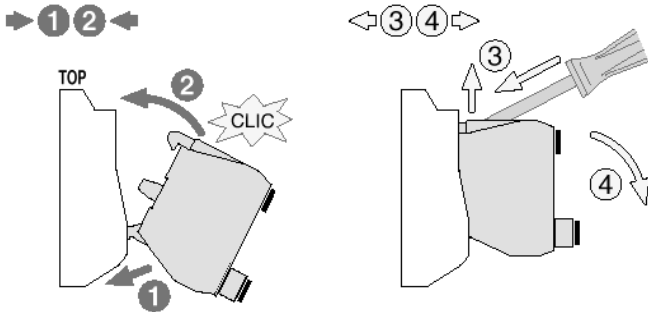

Assembling of PXB-B3. and PXB-B4. valves on the back of the electrical contact

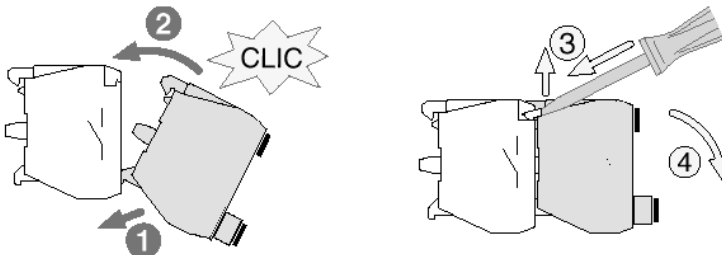

- Lightning fast response
- Simple long life mechanism
- Very high contrast
- All around visibility
- One single pipe connection
- Effective aid to diagnostics



Operating information

Working pressure 1-8 bar
 Working temperature -15 °C to +60 °C

Options and additional information

Connections Ø4 mm straight Push-in
 as standard

Order key

P X V - F 1 2 1 3 - E X

Ø	Colour, actuated	Connection	Colour, unactuated	ATEX Version *
F1 22 mm	1 White	1 Ø4 mm Push-in	1 White	ATEX Version *
M1 30 mm	2 Black	5 M5	2 Black	
	3 Green		3 Green	
	4 Red		4 Red	
	5 Yellow		5 Yellow	
	6 Blue		6 Blue	

*
 See :
 PDE2584TCUK-ev



Ø22 mm Visual Indicators

Black plastic bezel
In the actuated mode

Symbol	Colour *	Weight kg	Order code
	Green	0,080	PXV-F131
	Red	0,080	PXV-F141
	Yellow	0,080	PXV-F151
	Blue	0,080	PXV-F161
	White	0,080	PXV-F111

Ø22 mm Visual Indicators

Black plastic bezel
In the unactuated mode

Symbol	Colour *	Weight kg	Order code
	Green	0,080	PXV-F1213
	Red	0,080	PXV-F1214
	Yellow	0,080	PXV-F1215
	Blue	0,080	PXV-F1216
	White	0,080	PXV-F1211

* The pneumatic indicators are black in one position and coloured in the other.
The coloured position corresponds either to the presence of pressure (actuated mode)
or the absence of pressure (unactuated mode). For two different colours on the
same indicator, please consult Technical Sales Department

Dimensions

Ø22 mm visual indicators PXV-F1••

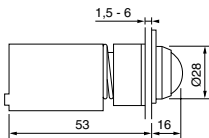

Minimum distance between centres

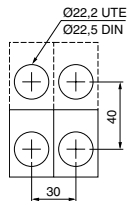

- Ergonomical design
- Easy to install
- Robust enclosure and rigid guards
- Meet requirements for protection against accidental operation and tempering
- Conforms to the EN574 and EN954-1 requirements



Specification

Material

Valve body	High grade polymer
Seals	Nitrile, NBR
Enclosure	High grade polymer or metal

Operating information

Working pressure	3-8 bar
Working temperature	-5 °C to +60 °C

European standard definition

EN 292-1 safety of machinery part 1
 Extract : two-hand control device
 A device which requires at least simultaneous actuation by use of both hands in order to initiate and to maintain, whilst a hazardous condition exists, any operation of a machine thus affording a measure of protection only for the person who actuates.

Conformity to standard

Conformity to the recommendation about health and security n° 89/392/CEE revised.



Ce Type examination Certificate

The two-hand control devices, here after, conform to models that have obtained CE Type test Certificate by the CETIM.

Description	Function	Order code	N°	CE Type examination Certificate				Cat
Control module	Logic unit	PXP-A11	N°	0526	520	4630	03 97	III A
Two-hand control device polyester enclosure	Single control	PXP-C111	N°	0526	520	4631	03 97	III A
Two-hand control device polyester enclosure	Dual control	PXP-D121	N°	0526	520	4632	03 97	III B
Two-hand control device metal enclosure	Single control	PXP-S111	N°	0526	520	4633	06 97	III A
Two-hand control device metal enclosure	Dual control	PXP-S121	N°	0526	520	4634	06 97	III B





Control module only

Symbol	Connections	Weight kg	Order code
 	Ø4 mm Push-in	0,250	PXP-A11

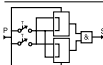

Complete units

Polyester enclosure, with two mushrooms head pushbuttons and control module(s)

Symbol	Connections	Number of control modules	Weight kg	Order code
 	Ø4 mm Push-in	1	1,000	PXP-C111
	Ø4 mm Push-in	2 **	1,000	PXP-D121

Complete units

Metal enclosure, with two Ø 60 push buttons with protective guards and control module(s)

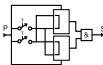
Symbol	Connections	Number of control modules	Weight kg	Order code
 	Push-in Ø6 mm for supply Ø4 mm for output	1	4,200	PXP-S111
	Push-in Ø6 mm for supply Ø4 mm for output	2 **	4,400	PXP-S121

Spare parts for two-hand control units

Description	Base component	Weight kg	Order code
1 guard for two-hand control	PXP-C111 PXP-D121	0,050	PPR-L15

[‡] These units are indispensable for ensuring that both operator's hands are occupied for reasons of safety. Both push-buttons must be operated simultaneously to produce an output signal.

** Conforming to french standard NFE 09-036 * Pneumatic synchronous two-hand controls*.

Dimensions, two-hand control unit, PXP Series

All dimensions in mm unless otherwise stated

PXP-A11

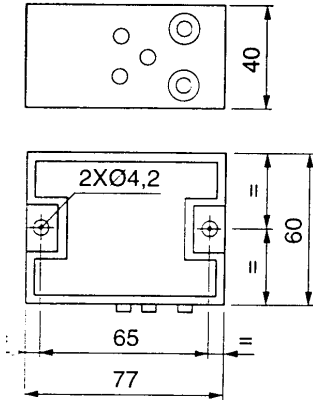

- (2) Pressure supply orifice $\text{Ø} 4$ mm (push-in)
- (3) Output signal orifice $\text{Ø} 4$ mm (push-in)

PXPC-111 and PXP-D121

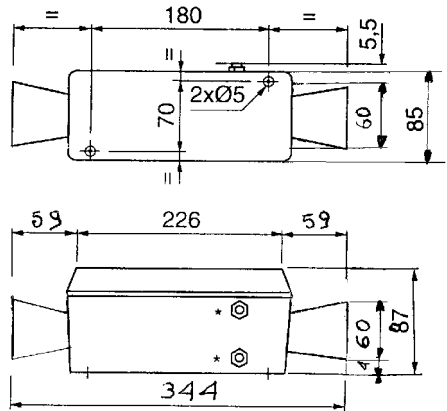

PXP-S111 and PXP-S121

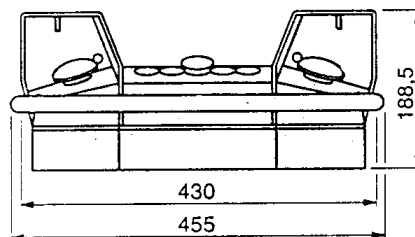
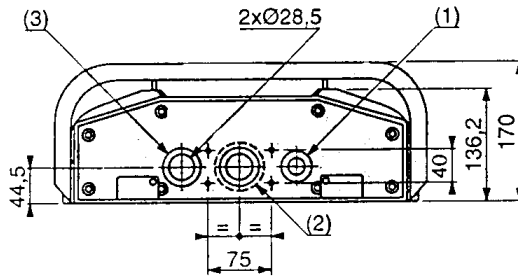

- (1) 1 hole for cable gland PG13
- (2) Pressure supply orifice $\text{Ø} 4$ mm (push-in)
- (3) Output signal orifice $\text{Ø} 4$ mm (push-in)



Q



R

Vacuum Products

Vacuum Products

A complete range of vacuum products and accessories

Vacuum Products
A complete range of vacuum products and accessories

Applications:
assembly
climate control
electrochemical
film blowing
fluid & gas handling
hydraulics
process control
printing & packaging

Parker
ENGINEERING YOUR

Parker is the world leader in motion and control technologies, providing systematic, precision-engineered solutions for a wide variety of, industrial markets. Throughout the world, Parker Hannifin is working together with companies to make their machines more reliable and more productive. Parker products are in operation on satellites orbiting the earth: in machine tools and mobile plant; on oil rigs and refineries; in hospitals and laboratories. In fact, wherever there are machines that depend on motion or fluid control, you will find innovative and reliable Parker components and systems.

The Parker Convum range of vacuum products is one of the most comprehensive in the market. The product range includes vacuum cups in wide variety of styles and materials, ejectors and generators from mini units to fully integrated units along with sensors and a wide selection of accessories.

Vacuum Products

Wide choice of styles and materials

Ventouses



- Flat & Bellows Pads
- Male & Female Connections
- Different Materials
- Range of Diameters

High performance accessories

Accessoires



- High performance silencers and vacuum filters
- Electronic cables with M8 connector 4 pin

Vacuum generators to suit most applications

Générateurs de vide



- Basic Ejectors
- Basic Ejectors with electro-mechanical Switch
- In-line Ejectors
- Integrated Ejectors small & large

Digital or analog out put

Vacuostats et pressostats



- -1 to +10 bar
- Analog and/or Digital Outputs
- With display

- Flat & Bellow Pads
- Male & Female Connections
- Different Materials
- Range of Diameters



Flat Pads - PFG

	Ø (mm)	Order code
	1	PFG-1-NBR
	1,5	PFG-1.5-NBR
	2	PFG-2A-NBR
	3,5	PFG-3.5A-NBR
	5	PFG-5A-NBR
	6	PFG-6A-NBR
	8	PFG-8A-NBR
	10	PFG-10A-NBR
	15	PFG-15A-NBR
	20	PFG-20B-NBR
	25	PFG-25-NBR
	30	PFG-30-NBR
	35	PFG-35-NBR
	40	PFG-40-NBR
	50	PFG-50-NBR
	60	PFG-60-NBR
	80	PFG-80-NBR
95	PFG-95-NBR	
120	PFG-120-NBR	
150	PFG-150-NBR	
200	PFG-200-NBR	

Flat Pads - Male Connection - PFTM

	Ø (mm)	Thread	Order code
	2	M5	PFTM-2A-NBR-M5
	3,5	M5	PFTM-3.5A-NBR-M5
	5	M5	PFTM-5A-NBR-M5
	5	G1/8	PFTM-5A-NBR-G1
	6	M5	PFTM-6A-NBR-M5
	6	G1/8	PFTM-6A-NBR-G1
	8	M5	PFTM-8A-NBR-M5
	8	G1/8	PFTM-8A-NBR-G1
	10	M5	PFTM-10A-NBR-M5
	10	G1/8	PFTM-10A-NBR-G1
	15	M5	PFTM-15A-NBR-M5
	15	G1/8	PFTM-15A-NBR-G1
	20	G1/8	PFTM-20B-NBR-G1
	20	G1/4	PFTM-20B-NBR-G2
	25	G1/8	PFTM-25-NBR-G1
	25	G1/4	PFTM-25-NBR-G2
	30	G1/8	PFTM-30-NBR-G1
	30	G1/4	PFTM-30-NBR-G2
	35	G1/8	PFTM-35-NBR-G1
	35	G1/4	PFTM-35-NBR-G2
	40	G1/8	PFTM-40-NBR-G1
40	G1/4	PFTM-40-NBR-G2	
50	G1/8	PFTM-50-NBR-G1	
50	G1/4	PFTM-50-NBR-G2	
60	G1/4	PFTM-60-NBR-G2	
80	G1/4	PFTM-80-NBR-G2	
95	G1/4	PFTM-95-NBR-G2	

Flat Pads - Female Connection - PFTF

	Ø (mm)	Thread	Order code
	5	G1/8	PFTF-5A-NBR-G1
	6	G1/8	PFTF-6A-NBR-G1
	8	G1/8	PFTF-8A-NBR-G1
	10	G1/8	PFTF-10A-NBR-G1
	15	G1/8	PFTF-15A-NBR-G1
	20	G1/8	PFTF-20B-NBR-G1
	20	G1/4	PFTF-20B-NBR-G2
	25	G1/8	PFTF-25-NBR-G1
	25	G1/4	PFTF-25-NBR-G2
	30	G1/8	PFTF-30-NBR-G1
	30	G1/4	PFTF-30-NBR-G2
	35	G1/8	PFTF-35-NBR-G1
	35	G1/4	PFTF-35-NBR-G2
	40	G1/8	PFTF-40-NBR-G1
	40	G1/4	PFTF-40-NBR-G2
	50	G1/8	PFTF-50-NBR-G1
	50	G1/4	PFTF-50-NBR-G2
	60	G1/4	PFTF-60-NBR-G2
	80	G1/4	PFTF-80-NBR-G2
	95	G1/4	PFTF-95-NBR-G2
120	G1/2	PFTF-120-NBR-G4	
150	G1/2	PFTF-150-NBR-G4	
200	G1/2	PFTF-200-NBR-G4	

Flat Pads - Reinforced Female Connection - CFS

	Ø (mm)	Thread	Order code
	20	M5	P5V-CFS02035N
	30	M5	P5V-CFS03035N
	50	G1/8	P5V-CFS05011N
	75	G1/4	P5V-CFS07512N
	100	G3/8	P5V-CFS10013N
	150	G1/2	P5V-CFS15014N
	300	G1	P5V-CFS30018N

Indicates stocked product.

1.1/2 Bellow Pads - PBG

Ø (mm)	Order code
10	PBG-10A-NBR
15	PBG-15A-NBR
20	PBG-20B-NBR
30	PBG-30-NBR
40	PBG-40-NBR
50	PBG-50-NBR
75	PBG-75-NBR
110	PBG-110-NBR
150	PBG-150-NBR



1.1/2 Bellow Pads - Male Connection - PBTM

Ø (mm)	Thread	Order code
10	M5	PBTM-10A-NBR-M5
10	G1/8	PBTM-10A-NBR-G1
15	M5	PBTM-15A-NBR-M5
15	G1/8	PBTM-15A-NBR-G1
20	G1/8	PBTM-20B-NBR-G1
20	G1/4	PBTM-20B-NBR-G2
30	G1/8	PBTM-30-NBR-G1
30	G1/4	PBTM-30-NBR-G2
40	G1/8	PBTM-40-NBR-G1
40	G1/4	PBTM-40-NBR-G2
50	G1/8	PBTM-50-NBR-G1
50	G1/4	PBTM-50-NBR-G2
75	G1/4	PBTM-75-NBR-G2



1.1/2 Bellow Pads - Female Connection - PBTF

Ø (mm)	Thread	Order code
10	G1/8	PBTF-10A-NBR-G1
15	G1/8	PBTF-15A-NBR-G1
20	G1/8	PBTF-20B-NBR-G1
20	G1/4	PBTF-20B-NBR-G2
30	G1/8	PBTF-30-NBR-G1
30	G1/4	PBTF-30-NBR-G2
40	G1/8	PBTF-40-NBR-G1
40	G1/4	PBTF-40-NBR-G2
50	G1/8	PBTF-50-NBR-G1
50	G1/4	PBTF-50-NBR-G2
75	G1/4	PBTF-75-NBR-G2
110	G1/2	PBTF-110-NBR-G4
150	G1/2	PBTF-150-NBR-G4



2.1/2 Bellow Pads - PCG

Ø (mm)	Order code
5	PCG-5-NBR
7	PCG-7-NBR
9	PCG-10-NBR
14	PCG-15-NBR
18	PCG-18-NBR
20	PCG-20-NBR
32	PCG-30-NBR
42	PCG-40-NBR
62	PCG-60-NBR
88	PCG-90-NBR



2.1/2 Bellow Pads - Male Connection - PCTM

Ø (mm)	Thread	Order code
5	M5	PCTM-5-NBR-M5
5	G1/8	PCTM-5-NBR-G1
7	M5	PCTM-7-NBR-M5
7	G1/8	PCTM-7-NBR-G1
9	M5	PCTM-10-NBR-M5
9	G1/8	PCTM-10-NBR-G1
14	M5	PCTM-15-NBR-M5
14	G1/8	PCTM-15-NBR-G1
18	M5	PCTM-18-NBR-M5
18	G1/8	PCTM-18-NBR-G1
20	M5	PCTM-20-NBR-M5
20	G1/8	PCTM-20-NBR-G1
32	G1/8	PCTM-30-NBR-G1
32	G1/4	PCTM-30-NBR-G2
42	G1/8	PCTM-40-NBR-G1
42	G1/4	PCTM-40-NBR-G2
62	G1/8	PCTM-60-NBR-G1
62	G1/4	PCTM-60-NBR-G2
88	G1/4	PCTM-90-NBR-G2

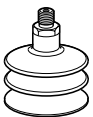

2.1/2 Bellow Pads - Female Connection - PCTF

Ø (mm)	Thread	Order code
5	G1/8	PCTF-5-NBR-G1
7	G1/8	PCTF-7-NBR-G1
9	G1/8	PCTF-10-NBR-G1
14	G1/8	PCTF-15-NBR-G1
18	G1/8	PCTF-18-NBR-G1
20	G1/8	PCTF-20-NBR-G1
32	G1/8	PCTF-30-NBR-G1
32	G1/4	PCTF-30-NBR-G2
42	G1/8	PCTF-40-NBR-G1
42	G1/8	PCTF-40-NBR-G2
62	G1/8	PCTF-60-NBR-G1
62	G1/4	PCTF-60-NBR-G2
88	G1/4	PCTF-90-NBR-G2



Other materials than NBR (nitrile) available
 SI (silicone)
 U (urethane)

Indicates stocked product.

R

- Basic Ejectors
- Basic Ejectors with electro-mechanical Switch
- In-line Ejectors
- Integrated Ejectors small & large

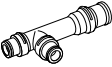

In-line Ejectors - MCA

	Vac %	Vac flow NI/min.	Order code
	86	5	MCA05HST6T6G1
	86	5	MCA05HST6T6T6
	60	9	MCA05LST6T6G1
	60	9	MCA05LST6T6T6
	86	11,5	MCA07HST6T6G1
	86	11,5	MCA07HST6T6T6
	50	19,5	MCA07LST6T6G1
	50	19,5	MCA07LST6T6T6
	90	25	MCA10HST6T6G2
	90	25	MCA10HST6T6T8
	60	37	MCA10LST6T6G2
	60	37	MCA10LST6T6T8
	92	35	MCA13HST6T6G2
	92	35	MCA13HST6T6T8

Ejector incl. blow-off - CV-VR

	Vac %	Vac flow NI/min.	Order code
	92	63	CV15HSVRG

Basic Ejectors - CV

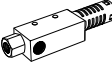
	Vac %	Vac flow NI/min.	Order code
	86	6	CV05HSG
	57	9	CV05LSG
	91	27	CV10HSG
	57	36	CV10LSG
	91	63	CV15HSG
	57	95	CV15LSG
	91	110	CV20HSG
	57	165	CV20LSG
	91	160	CV25HSG
	57	250	CV25LSG
	91	225	CV30AHSG
	57	350	CV30ALSG

Ejectors with electro-mech. switch - CV-CK

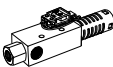
	Vac %	Vac flow NI/min.	Order code
	86	6	CV05HSCKG
	57	9	CV05LSCKG
	91	27	CV10HSCKG
	57	36	CV10LSCKG
	91	63	CV15HSCKG
	57	95	CV15LSCKG
	91	110	CV20HSCKG
	57	165	CV20LSCKG

R

Basic Ejectors - GAR

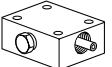
	Vac %	Vac flow NI/min.	Order code
	85	36	P5V-GAR0312
	85	53	P5V-GAR0614
	85	120	P5V-GAR1214
	85	290	P5V-GAR2414
	85	480	P5V-GAR4216
	85	600	P5V-GAR7214

Ejectors incl. AirSaver - GWV

	Vac %	Vac flow NI/min.	Order code
	90	14	P5V-GWV0214
	90	32	P5V-GWV0314
	90	50	P5V-GWV0414
	90	88	P5V-GWV0614

 Indicates stocked product.

Integrated Ejectors - (Small) - MC2

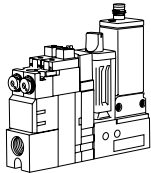
	Vac %	Vac flow NI/min.	Order code	Order code Sensor
	86	5,5	MC2S05HSZL24B5G	
	86	5,5	MC2S05HS12L24B5G	MPS-V1E-PC
	86	5,5	MC2S05HS02L24B5G	MVS-201-PCP
	53	10,5	MC2S05LSZL24B5G	
	53	10,5	MC2S05LS12L24B5G	MPS-V1E-PC
	53	10,5	MC2S05LS02L24B5G	MVS-201-PCP
	86	11	MC2S07HSZL24B5G	
	86	11	MC2S07HS12L24B5G	MPS-V1E-PC
	86	11	MC2S07HS02L24B5G	MVS-201-PCP
	53	20,5	MC2S07LSZL24B5G	
	53	20,5	MC2S07LS12L24B5G	MPS-V1E-PC
	53	20,5	MC2S07LS02L24B5G	MVS-201-PCP
	86	20	MC2S10HSZL24B5G	
	86	20	MC2S10HS12L24B5G	MPS-V1E-PC
	86	20	MC2S10HS02L24B5G	MVS-201-PCP

Integrated Ejectors - (Large) - CVK

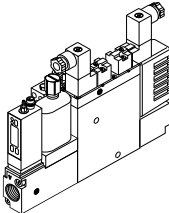
	Vac %	Vac flow NI/min.	Order code	Order code Sensor
	90	60	CVK15HSZC24BDG	
	90	60	CVK15HS22C24BDG	MPS-V2G-PC
	90	60	CVK15HS02C24BDG	MVS-201-PCP
	90	60	CVK15HS62C24BDG	MPS-V6C-PC
	55	90	CVK15LSZC24BDG	
	55	90	CVK15LS22C24BDG	MPS-V2G-PC
	55	90	CVK15LS02C24BDG	MVS-201-PCP
	55	90	CVK15LS62C24BDG	MPS-V6C-PC
	90	100	CVK20HSZC24BDG	
	90	100	CVK20HS22C24BDG	MPS-V2G-PC
	90	100	CVK20HS02C24BDG	MVS-201-PCP
	90	100	CVK20HS62C24BDG	MPS-V6C-PC
	55	155	CVK20LSZC24BDG	
	55	155	CVK20LS22C24BDG	MPS-V2G-PC
	55	155	CVK20LS02C24BDG	MVS-201-PCP
	55	155	CVK20LS62C24BDG	MPS-V6C-PC
	90	150	CVK27HSZC24BDG	
	90	150	CVK27HS22C24BDG	MPS-V2G-PC
	90	150	CVK27HS02C24BDG	MVS-201-PCP
	90	150	CVK27HS62C24BDG	MPS-V6C-PC

Moduflex Vacuum Generators - P2M

Order code for Size 1 vacuum generator (90% vac. - 25 NI/min)	
Basic module	P2M1PXVA
I: 2 unions - V: 2 x 6mm straight - E: Silencer	P2M1PXVAJJAF6AMA
I: 2 unions - V: 6mm straight + plug - E: Silencer	P2M1PXVAJJAF6BMA
I: 2 x 6mm straight - V: 2 x 6mm straight - E: Silencer	P2M1PXVAF6AF6AMA
I: 2 x 6mm straight - V: 6mm straight + plug - E: Silencer	P2M1PXVAF6AF6BMA
I: 6mm straight + plug - V: 2 x 6mm straight - E: Silencer	P2M1PXVAF6BF6AMA
I: 6mm straight + plug - V: 6mm straight + plug - E: Silencer	P2M1PXVAF6BF6BMA

I = Input V = Vacuum E = Exhaust

 Indicates stocked product.

R

- -1 to +10 bar
- Analog and/or Digital Outputs
- With display



Sensors

	Pressure range	Output	Connection		Order code
			electrical	pneumatic	
	-1 to 0 bar	1 analog / 7 amp.	conn.	G1/8	P5V-SVVA16K
	-1 to 0 bar	1 analog & 1 digit	M8	G1/8	MPS-V1G-PC
	0 to +10 bar	1 analog & 1 digit	M8	G1/8	MPS-P1G-PC
	-1 to 0 bar	1 analog & 1 digit	M8	Flange	MPS-V1E-PC
	0 to +10 bar	1 analog & 1 digit	M8	Flange	MPS-P1E-PC
	-1 to 0 bar	1 digit	M8	Flange	MPS-V1E-PC3
	-1 to 0 bar	2 digit	M8	G1/8	MPS-V2G-PC
	0 to +10 bar	2 digit	M8	G1/8	MPS-P2G-PC
	-1 to 0 bar	2 digit	M8	G1/8	MPS-V3G-PC
	0 to +10 bar	2 digit	M8	G1/8	MPS-P3G-PC
	-1 to 0 bar	2 digit	M8	Tube	MPS-V6T-PC
	-1 to 0 bar	2 digit	Cable	Tube	MPS-V6T-PG
	-1 to 0 bar	2 digit	M8	G1/8	MPS-V6G-PC
	-1 to 0 bar	2 digit	Cable	G1/8	MPS-V6G-PG
	-1 to 0 bar	1 analog	Cable	Tube	MPS-V6T-AGE
	0 to +10 bar	1 analog	Cable	Tube	MPS-P6T-AGE
			Cable		MPS-71E-PG
		Cable		MPS-74E-PG	

Vacuum accessories

- High performance silencers and vacuum filters
- Electronic cables with M8 connector 4 pin



Electronic cables

	Order code
	CB-M8-4P-2M
	CB-M8-4P-5M
	CB-M8-4P-5M-90

Silencers

Thread	Order code
G 3/4	MS6-01
G 1/2	MSL02
G 1/4	MSM-01
G 1/8	MSS-01

Vacuum filters

	Order code
	VF-11
	VF-2
	VF-3
	VF-5
	VF-6
	VFL-44
	VFL-66

Vacuum cut-off valve

Thread	Order code
M5	P5V-BKS35
G1/8	P5V-BKS11
G1/4	P5V-BKS12

Thread	Order code
G3/8	P5V-BKS13
G1/2	P5V-BKS14

Indicates stocked product.

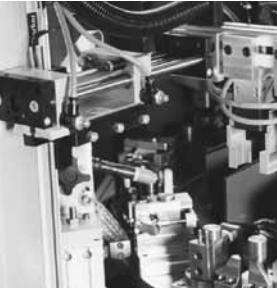

S

ADEX Valves

Miniature Directional Control Valves M5 - G1/8

A05 Series**A12 Series****Compact body with large flow**

It allows flexibility on your applications saving space and reducing costs.

These series is most suitable for driving cylinders of $\varnothing 10$ to $\varnothing 100$ in diameter.

Quick response time, faster than 10 ms

(A05 series, Single solenoid)

Uniquely designed pilot valve with fast response time and low power consumption.

Tested life time more than 50,000,000 times

(Based on Parker laboratory test conditions)

ADEX valves feature the well-reputed WCS (Wear Compensation System) in the main spool, resulting in low sliding friction and long service life.

Low power consumption only 0,6 W

(With indicator light and surge suppressor)

Direct drive from PLC is possible, contributing to cost reduction as well as down sizing of the DC power supply.

Multipin connector version

Connection by sub-D25 on sub-base.

**In-line or sub bases mounted
(side ported) versions****A05** 5/2 and 5/3 versions

Body width **10 mm**

Output ports **M5**

**A12** 5/2 and 5/3 versions

Body width **15 mm**

Output ports **G^{1/8}**



Captured exhaust from main valve and pilot valve

(Sub-base mounting type)

Exhaust air from pilot valve is captured together with exhaust air from main valve.

Unlike conventional exhaust systems, exhaust air from pilot valve is not directly discharged to outside. This takes to prevent air contamination in the atmosphere.

Manual override

Screwdriver-operated manual override is standard.

Multipurpose tag available

For the convenience of installation, testing, maintenance tag can be mounted on the upside of solenoid valve body.

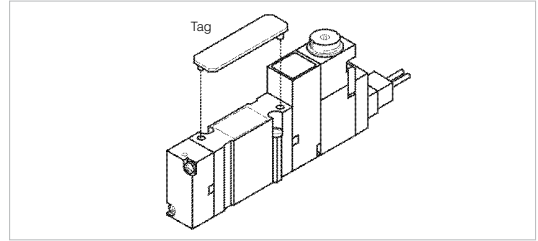
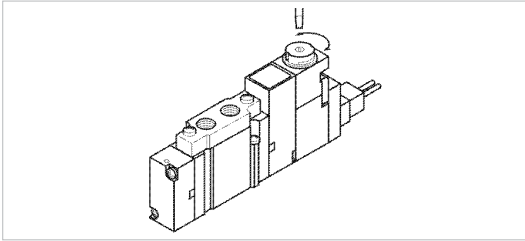

In-line IEM Valves



Series	A05R	A12R
Internal Pilot Supply	●	●
Single Solenoid 5/2	●	●
Double Solenoid 5/2	●	●
Closed Centre 5/3	●	●
Vented Centre 5/3	●	●
Pressurised Centre 5/3	●	●
Indicator LED & Surge Suppressor	●	●
Manual Override	●	●
In-line Mounting	●	●
IEM Manifold Mounting	●	●
Sub-base Mounting		
Electrical Collective Wiring	●	●
Port Sizes	M5	G1/8

Diameter of controlled cylinder

Pressure : 5 bar

Load factor : 0.5

Cylinder speed m/s :

0,15 0,30 0,45 0,60 0,75

0,15 0,30 0,45 0,60 0,75

Tube length : 1 m

Tube diameter : A05 : 6 x 4 mm

A12 : 8 x 6 mm

Ø 6																			
Ø 10																			
Ø 16																			
Ø 20																			
Ø 25																			
Ø 32																			
Ø 40																			
Ø 50																			
Ø 63																			
Ø 80																			
Ø 100																			

S

Sub-base Mounted Valves



Series	A05R	A12R
Internal Pilot Supply	●	●
Single Solenoid 5/2	●	●
Double Solenoid 5/2	●	●
Closed Centre 5/3	●	●
Vented Centre 5/3	●	●
Pressurised Centre 5/3	●	●
Indicator LED & Surge Suppressor	●	●
Manual Override	●	●
In-line Mounting		
IEM Manifold Mounting		
Sub-base Mounting	●	●
Electrical Collective Wiring	●	●
Port Sizes	M5	G1/8

Diameter of controlled cylinder
 Pressure : 5 bar
 Load factor : 0.5
 Cylinder speed m/s :

0,15 0,30 0,45 0,60 0,75 0,15 0,30 0,45 0,60 0,75

Tube length : 1 m
 Tube diameter : A05 : 6 x 4 mm
 A12 : 8 x 6 mm

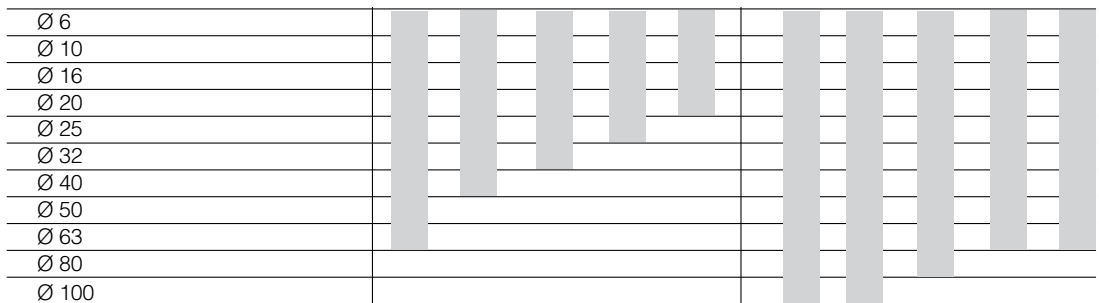

S

- 0,6 W low power solenoid
- Fast response time
- Vacuum version available on request
- Impulse and turn to lock manual override

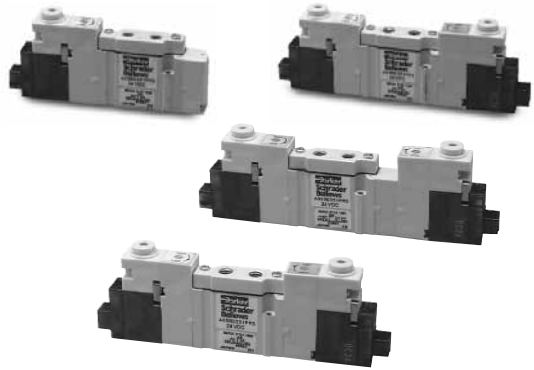

Operating information

Working pressure : 5/2 monos. 1,5 to 7,1 bar
 5/2 bistable 1 to 7,1 bar
 5/3 CC, CV, CP 2 to 7,1 bar

Working temperature : -5°C to +50°C
 Storage temperature : -40°C to +70°C
 Fluid : air or gaz 50µm filtered
 lubricated or not

Response time :

(VDC)	Response time : ms	5/2 bi.		
		5/2 monos.	5/2 bi.	5/3
A05R	On	10	10	10
	Off	10	-	15
A12R	On	15	10	12
	Off	18	-	36
A05P	On	10	10	10
	Off	10	-	15
A12P	On	15	10	12
	Off	18	-	36

Expected mechanical life with dry air at 6 bar 20°C 1 Hz : 50 million cycles
 Orientation : any plane
 Maximum operating frequency : cycles/min. : 5/2; 600 (10Hz) - 5/3; 500
 Degree of protection : IP 40

Note : Above mentioned datas apply for intermittent duty, for continuous duty : please consult us.

Operating voltage : 12 and 24 VDC
 -10% to +10% intermittent duty and -10% to 0% continuous duty

Surge suppression : Diode for DC version
 Consumption : 0,55 W (without LED)
 0,6W (with LED indicator light)

Wiring : Connector 2,54mm pin spacing

*Cv measurement : there are several ways to determine Cv valves, resulting in some Cv been overstated by 20 to 40%. This can adversely affect the user's application because the valve flows less than the quoted Cv.

Parker's Cv valve is calculated using the ANSI (NFPA) T3-21-3-1990 standard. The ANSI (NFPA) method is a structured test using very specific tube sizes and length, inlet pressures, pressures drop and volume chambers.

Flow characteristics

		5/2 monostable	5/2 bistable	5/3 close center
In-line IEM		A05RS25	A05RD25	A05RD35
A05	Cv*	0,17	0,17	0,16
In-line IEM		A12RS25	A12RD25	A12RD35
A12	Cv*	0,47	0,47	0,43
Sub-base		A05PS25	A05PD25	A05PD35
A05	Cv*	0,18	0,18	0,16
Sub-base		A12PS25	A12PD25	A12PD35
A12	Cv*	0,44	0,44	0,40

Main data for directional control valves A05R and A12R series

Electrically actuated 5/2 single solenoid



Symbol	Threaded connection	Voltage	Order code
	M5	24 VDC	A05RS251PM5MF
	G1/8	24 VDC	A12RS251PG1MF

Electrically actuated 5/2 double solenoid



Symbol	Threaded connection	Voltage	Order code
	M5	24 VDC	A05RD251PM5MF
	G1/8	24 VDC	A12RD251PG1MF

Electrically actuated 5/3 closed centre



Symbol	Threaded connection	Voltage	Order code
	M5	24 VDC	A05RD351PM5MF
	G1/8	24 VDC	A12RD351PG1MF

Electrically actuated 5/3 vented centre



Symbol	Threaded connection	Voltage	Order code
	M5	24 VDC	A05RE351PM5MF
	G1/8	24 VDC	A12RE351PG1MF

Electrically actuated 5/3 pressurised centre



Symbol	Threaded connection	Voltage	Order code
	M5	24 VDC	A05R0351PM5MF
	G1/8	24 VDC	A12R0351PG1MF

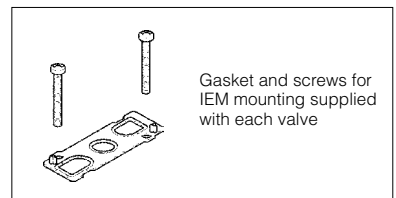

S

Main data for manifolds for directional control valves A05R/A12R series

Manifold for in-line valve with individual electric connector



No. of stations	Port size	Size	Order Code
4	M5	A05	MMFU4A05G
	G ¹ / ₈	A12	MMFU4A12G
6	M5	A05	MMFU6A05G
	G ¹ / ₈	A12	MMFU6A12G
8	M5	A05	MMFU8A05G
	G ¹ / ₈	A12	MMFU8A12G
10	M5	A05	MMFU10A05G
	G ¹ / ₈	A12	MMFU10A12G
12	M5	A05	MMFU12A05G
	G ¹ / ₈	A12	MMFU12A12G

Manifold for in-line valve with Sub-D collective wiring module



No. of stations	Port size	Size	Order Code
4	M5	A05	MMCU4A05G
	G ¹ / ₈	A12	MMCU4A12G
6	M5	A05	MMCU6A05G
	G ¹ / ₈	A12	MMCU6A12G
8	M5	A05	MMCU8A05G
	G ¹ / ₈	A12	MMCU8A12G
10	M5	A05	MMCU10A05G
	G ¹ / ₈	A12	MMCU10A12G
12	M5	A05	MMCU12A05G
	G ¹ / ₈	A12	MMCU12A12G

Collective wiring add-on module



No. of stations	Size	Order Code
4	A05	MCS4A05PDL
	A12	MCS4A12PDL
6	A05	MCS6A05PDL
	A12	MCS6A12PDL
8	A05	MCS8A05PDL
	A12	MCS8A12PDL
10	A05	MCS10A05PDL
	A12	MCS10A12PDL
12	A05	MCS12A05PDL
	A12	MCS12A12PDL

Collective wiring pin mapping

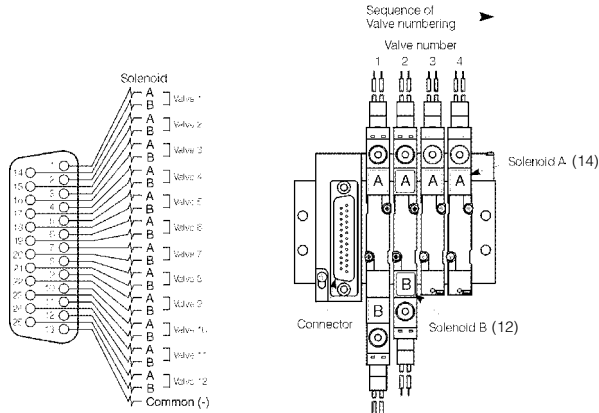

Pin map for Sub-D25 connector

Valve and solenoid addresses

Main data for directional control valves A05P/A12P series

Electrically actuated 5/2 single solenoid



Symbol	Voltage	Size	Order code
	24 VDC	A05	A05PS251P
	24 VDC	A12	A12PS251P

Electrically actuated 5/2 double solenoid



Symbol	Voltage	Size	Order code
	24 VDC	A05	A05PD251P
	24 VDC	A12	A12PD251P

Electrically actuated 5/3 closed centre



Symbol	Voltage	Size	Order code
	24 VDC	A05	A05PD351P
	24 VDC	A12	A12PD351P

Electrically actuated 5/3 vented centre



Symbol	Voltage	Size	Order code
	24 VDC	A05	A05PE351P
	24 VDC	A12	A12PE351P

Electrically actuated 5/3 pressurised centre



Symbol	Voltage	Size	Order code
	24 VDC	A05	A05P0351P
	24 VDC	A12	A12P0351P

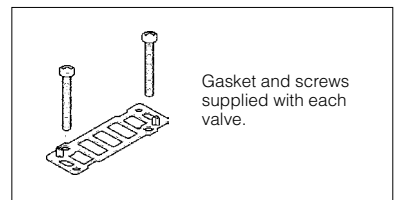

S

Main data for manifolds for directional control valves A05P/A12P series

Manifold side ported BSPP thread, for valves with individual electrical wiring



No. of stations	Port size	Size	Order Code
4	M5	A05	MMFS4A05GM5
	G ¹ / ₈	A12	MMFS4A12GG1
6	M5	A05	MMFS6A05GM5
	G ¹ / ₈	A12	MMFS6A12GG1
8	M5	A05	MMFS8A05GM5
	G ¹ / ₈	A12	MMFS8A12GG1
10	M5	A05	MMFS10A05GM5
	G ¹ / ₈	A12	MMFS10A12GG1
12	M5	A05	MMFS12A05GM5
	G ¹ / ₈	A12	MMFS12A12GG1

Manifold side ported BSPP thread, for Sub D-collective wiring module





No. of stations	Port size	Size	Order Code
4	M5	A05	MMCS4A05GM5
	G ¹ / ₈	A12	MMCS4A12GG1
6	M5	A05	MMCS6A05GM5
	G ¹ / ₈	A12	MMCS6A12GG1
8	M5	A05	MMCS8A05GM5
	G ¹ / ₈	A12	MMCS8A12GG1
10	M5	A05	MMCS10A05GM5
	G ¹ / ₈	A12	MMCS10A12GG1
12	M5	A05	MMCS12A05GM5
	G ¹ / ₈	A12	MMCS12A12GG1

Collective wiring add-on module (supplied with mounting screws) for MMCS... manifolds

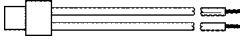
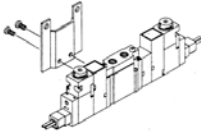
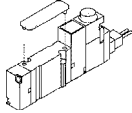
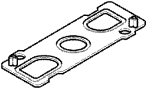
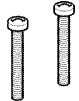

No. of stations	Size	Order Code
4	A05	MCS4A05PDL
	A12	MCS4A12PDL
6	A05	MCS6A05PDL
	A12	MCS6A12PDL
8	A05	MCS8A05PDL
	A12	MCS8A12PDL
10	A05	MCS10A05PDL
	A12	MCS10A12PDL
12	A05	MCS12A05PDL
	A12	MCS12A12PDL

For wiring pin mapping see page 8

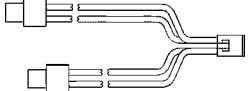
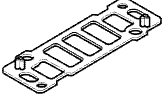
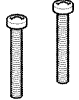
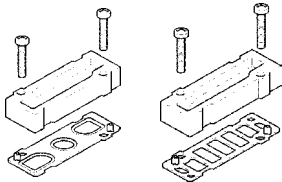
	Description	Order code
	Connector with lead wire black (-), red (+), length 500mm	A05PDCCCL5
	Connector with lead wire black (-), red (+), length 1000mm	A05PDCCCL10
	Mounting bracket A05R (1 bracket with 2 screws)	A05RBS
	Mounting bracket A12R (1 bracket with 2 screws)	A12RBS
	Identification tag for sub-base valves (pack of 10)	A05PN
	IEM gasket (pack of 10) for A05R/A12R	A05RG A12RG
	IEM mounting screws (pack of 20) for A05R/A12R	A05RS A12RS
	Collective wiring connector Single solenoid PNP	A05PSCCM A12PSCCM
	Collective wiring connector Double solenoid PNP	A05PDCCM A12PDCCM
	Sub-base gasket (pack of 10) for A05P/A12P	A05PG A12PG
	Sub-base mounting screws (pack of 20) for A05P/A12P	A05PS A12PS
	IEM blanking plate kit (pack of 5)	A05RGBP A12RGBP
	Sub-base blanking plate kit (pack of 5)	A05PGBP A12PGBP

S

A05R - Single and double operators - Body ported

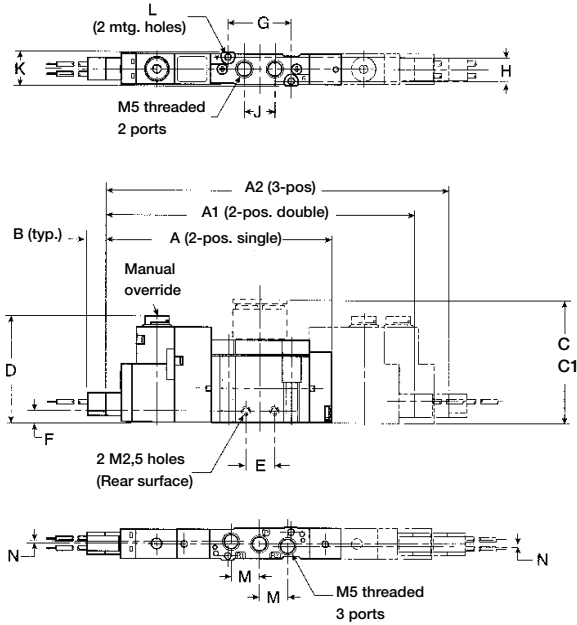

A05R - Body ported

A	A1	A2	B	C
74	100	108	6	-
C1	D	E	F	G
-	34,6	9,6	4	21
H	J	K	L	M
8,5	10,2	11,4	Ø2,1	9,5

N
1

Dimensions in mm

A12R - Single and double operators - Body ported

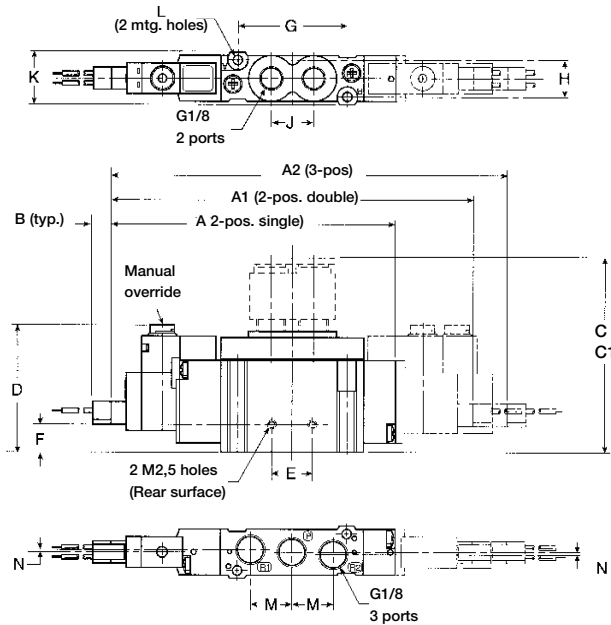

A12R - Body ported

A	A1	A2	B	C
93,5	119	130	6	-
C1	D	E	F	G
-	41,6	13,4	9	36
H	J	K	L	M
12	14	17,2	Ø3,1	13,6

N
0,8

Dimensions in mm

A05R - Manifold - Valve body ports

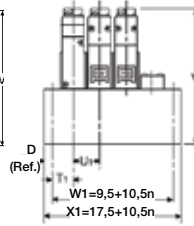
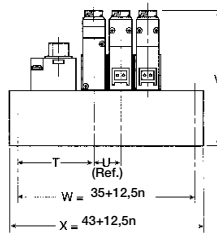
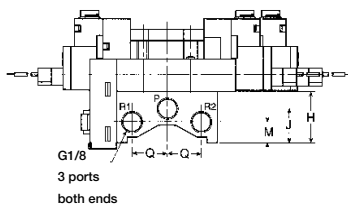
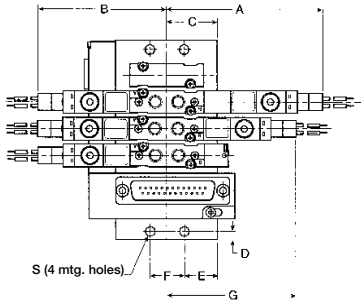

A05R - Manifold - Valve body port

A	B	C	D	E
64	56	23,5	4	15,5
F	G	H	J	M
16	56	24	15,5	9,5
Q	S	T	T1	U
16	Ø4,5	34	10	12,5
U1	V			
10,5	63			

Dimensions in mm

n = number of stations

MMCU...

MMFU...

A12R - Manifold - Valve body ports

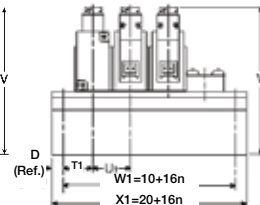
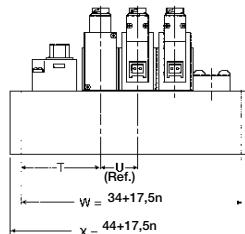
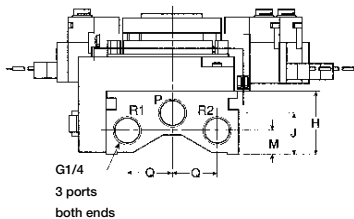
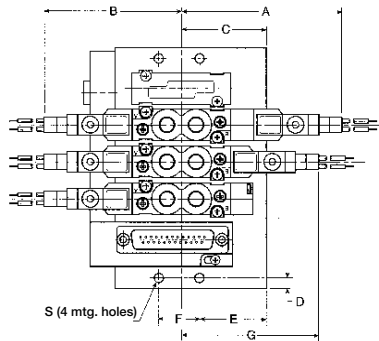

A12R - Manifold - Valve body port

A	B	C	D	E
77	66	29	5	19,2
F	G	H	J	M
19,6	66	27,5	18	10,5
Q	S	T	T1	U
19,5	Ø4,5	37,5	12,2	17,5
U1	V			
16	70			

Dimensions in mm

n = number of stations

MMCU...

MMFU...

S

A05P - Single and double operators - Sub-base

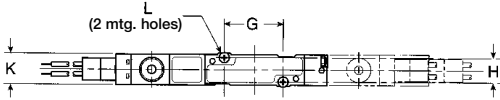

A05P - Subbase

A	A1	A2	B	D
74	100	108	6	35,1
G	H	K	L	
19	8,5	10	Ø2,1	

Dimensions in mm

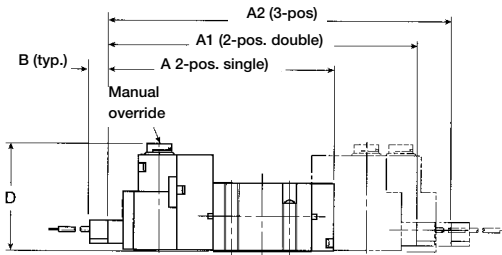

A12P - Single and double operators - Sub-base

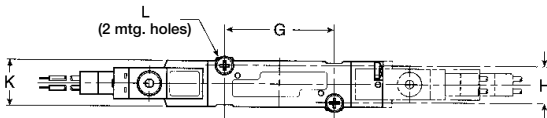

A05P - Subbase

A	A1	A2	B	D
93,5	119	130	6	39,1
G	H	K	L	
34	12	15	Ø3,1	

Dimensions in mm

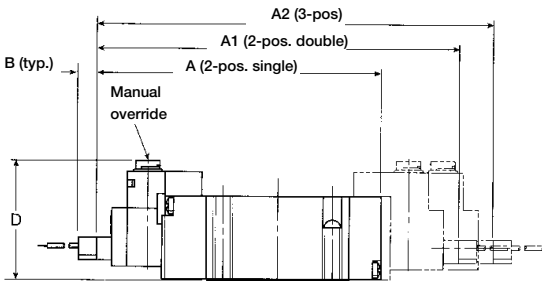

S

A05P - Manifold - Side ports

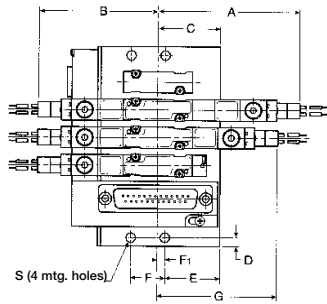

A05P - Manifold - Side ports

A	B	C	D	E
64	56	30,2	4	25,5
F	F1	G	H	J
16	4,7	56	32	28
L	M	N	P	O
14,5	11,5	14	3	16
R	S	T	T1	U
18	Ø4,5	33,8	10	12,5
U1	V			
10,5	67			

Dimensions in mm

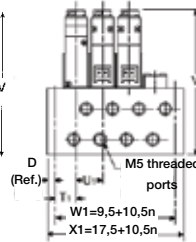
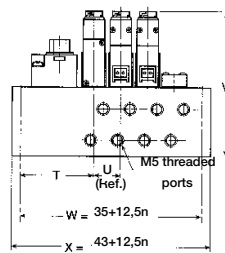
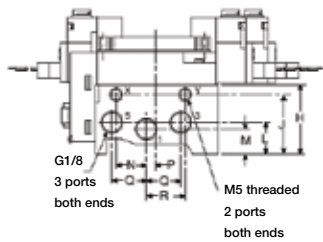

n = number of stations

MMCS...

MMFS...

A12P - Manifolds - Side ports

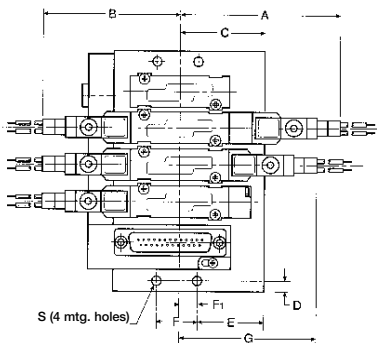

A12P - Manifold - Side ports

A	B	C	D	E
77	66	40,4	5	31,7
F	F1	G	H	J
19,6	11	66	39,5	35
K	L	M	N	P
20,5	18	14	22	1
Q	R	S	T	T1
19,5	23	Ø4,5	37,2	12,7
U	V			
17,5	79			

Dimensions in mm

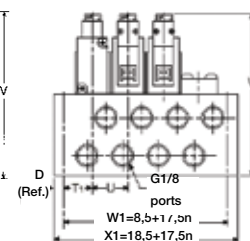
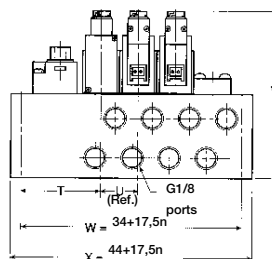
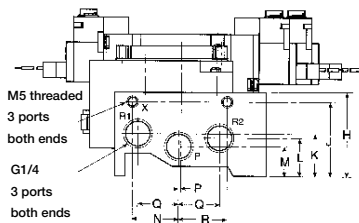

n = number of stations

MMCS...

MMFS...

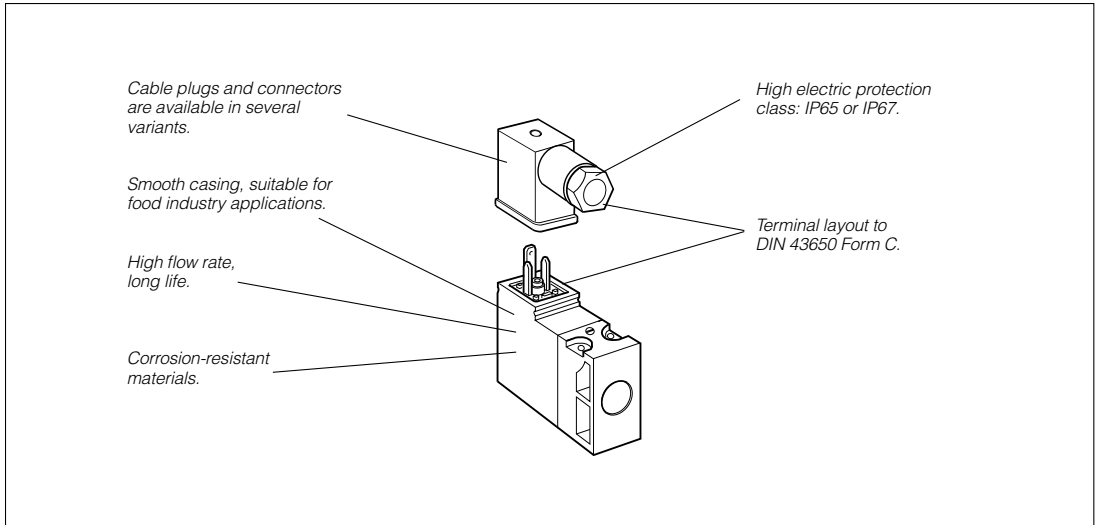
Solenoid operators - 15mm**The P2E-•V solenoid operator range**

The P2E-•V range of operators are normally closed (NC) 3/2 solenoid valves, with exceedingly compact dimensions in relation to their capacity.

International standard

The port connection pattern complies with a new French CNOMO standard (in process of drafting), with cable plug connections in accordance with DIN 43650 Form C.

Compact design

Overall dimensions of the P2E-•V operators are substantially less than those of earlier generations of solenoid operators.

High flow capacity

High flow capacity relative to the electrical operating power as a result of optimised internal flow paths.

Corrosion-resistant design

The valve is made of thermoplastic material and stainless steel, with Viton™ and nitrile rubber seals for excellent corrosion resistance.

Clean lines suitable for food industry applications, P2E-QV

The valve has been designed in conjunction with several machine manufacturers and organisations in the food processing industry, with corrosion-resistant materials and smooth lines being important starting points. The valve and its accessories have been designed so that there are no gaps or crevices in which dirt could collect.

High reliability

Few moving parts result in high reliability, rapid changeover and very long life.

Low power demand

The solenoids have a power demand of 1.2 W at 24 V DC and 1.6 VA at 24 V AC, 115 V AC and 230 V AC.

Insensitive to dirty air

The use of generously sized flow paths (1.0 mm diameter) means that the valve can be used in normal industrial environments without problems of blocking.

Manual override as option

The operators can be supplied with or without manual override. The manual override device is available as a screwdriver groove or with a control arm, and is either spring return (blue) or lockable (yellow).

S

Order key, solenoid operators (15mm)

P	2	E	-	Q	V	3	2	C	3		
Valve family											
P2E Solenoid operator											
Subfamily											
Solenoid operator, 15 mm wide Electric connection acc. to ISO 15217 Form C EI/supply connection on opposite side											
K Standard version											
M Mobile version											
Q Food industry version											
						Type of current		Voltage		Overrides	
						1	AC 50 Hz	B	12 V	0	Without
						2	DC	C	24 V	1	Non locking (blue)
						4	AC 50/60 Hz	D	48 V	2	Locking (yellow)
						5	Mobile and wide band only	F	115 V*	3	Extended non locking (blue)
								J	230 V*	4	Extended locking (yellow)
								W	37,5 V**		
								T	72 V**		
								Y	78 V**		
								V	96 V**		
								E	110 V**		
								* For standard and food type only			
								** For mobile "M" version only			
						Valvetype/Function					
						3		3/2 valve, normally closed (NC)			

Technical data

	NC, Standard	NC, Food¹⁾	NC, Mobile²⁾
Working pressure	0 to 10 bar	0 to 10 bar	0 to 10 bar
Working temperature	-15 °C to +60 °C	-15 °C to +60 °C	-40 °C to +70 °C
Orifice	1,0 mm	1,0 mm	1,0 mm
Flow Qmax	33 Nl/min	33 Nl/min	22 Nl/min
Power, hold	DC 1,2 W / AC 1,6 VA	DC 1,2 W / AC 1,6 VA	DC 1,4 W
Power, surge	DC 1,2 W / AC 3,5 VA	DC 1,2 W / AC 3,5 VA	DC 1,4 W
Connection time	100%	100%	100%
Voltage tolerance	+10%/–15%	+10%/–15%	+25%/–30%
Electric connection:	DIN 43650 Form C		
Port pattern:	To future CNOMO standard		
Protection:	IP 65 - IP 67, depending on type of cable plug		
Approval:	Standard solenoids are UL-approved and marked with the following symbol 		
Working media:	All neutral media, such as compressed air, water, hydraulic oil and many gases.		
1) Design:	Completely smooth exterior, suitable for food industry.		
2) Mobile standard	According to European standard EN 50 155.		

Transients

Interrupting the current through the solenoid coil produces momentary voltage peaks which, under unfavourable conditions, can amount to several hundred times the rated operating voltage. Normally, these transients do not cause problems, but to achieve the maximum life of relays in the circuit (and particularly of transistors, thyristors and integrated circuits) it is desirable to provide protection by means of voltage-dependent resistors (varistors). All cable plugs with a yellow LED also incorporate such protection.

Service life

With compressed air at 6 bar, 20 °C and complying with the requirements for compressed air quality as set out in ISO8573-1 norm (class 4 for dry and class 5 for filtered air), the valves should have a life of at least 50 million cycles.

Materials

Operator

Body, coil casing	Thermoplastic
Internal metal parts	Steel
Screws	Stainless steel
Bottom plug	Thermoplastic
Sealing materials	FPM (Viton™) and nitrile rubber

Cable head

Sheath	Thermoplastic
Retaining screw	Stainless steel, zinc-plated steel

Control Devices

Solenoid Operators - 15mm

Electrical connection EN175301-803 C/ISO15217 (Ex DIN 43650C)

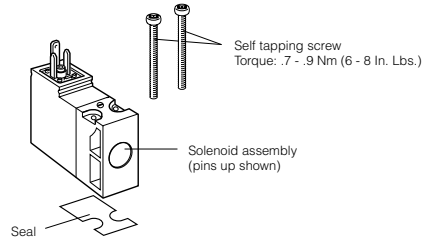

Solenoids 15 mm NC, standard

Note! Mounting screws included in basic valve

Voltage	Weight Kg	Order code Without manual override	Weight Kg	Order code Override, blue, non locking flush	Weight Kg	Order code Override, yellow, locking flush	
	12 VDC	0,038	P2E-KV32B0	0,038	P2E-KV32B1	0,038	P2E-KV32B2
	24 VDC	0,038	P2E-KV32C0	0,038	P2E-KV32C1	0,038	P2E-KV32C2
	48 VDC	0,038	P2E-KV32D0	0,038	P2E-KV32D1	0,038	P2E-KV32D2
	24 VAC 50Hz	0,038	P2E-KV31C0	0,038	P2E-KV31C1	0,038	P2E-KV31C2
	48 VAC 50/60Hz	0,038	P2E-KV34D0	0,038	P2E-KV34D1	0,038	P2E-KV34D2
	115 VAC 50Hz/ 120 VAC 60Hz	0,038	P2E-KV31F0	0,038	P2E-KV31F1	0,038	P2E-KV31F2
	230 VAC 50Hz/ 240 VAC 60Hz	0,038	P2E-KV31J0	0,038	P2E-KV31J1	0,038	P2E-KV31J2
	Voltage						
	24 VDC			0,038	P2E-KV32C3	0,038	P2E-KV32C4
	24 VAC 50Hz			0,038	P2E-KV31C3	0,038	P2E-KV31C4

Solenoids 15 mm NC, mobile

(Note! Mounting screws included in basic valve)

Voltage	Weight Kg	Order code Without manual override	Weight Kg	Order code Override, blue, non locking flush	
	12 VDC	0,038	0,038	P2E-MV35B1	
	24 VDC	0,038	0,038	P2E-MV35C1	
	37,5 VDC	0,038	0,038	P2E-MV35W1	
	48 VDC	0,038	0,038	P2E-MV35D1	
	72 VDC	0,038	0,038	P2E-MV35T1	
	78 VDC	0,038	0,038	P2E-MV35Y1	
	96 VDC	0,038	0,038	P2E-MV35V1	
	110 VDC	0,038	0,038	P2E-MV35E1	
	Weight				
	24 VDC			0,038	P2E-MV35C3
24 VAC 50Hz			0,038	P2E-MV31C3	

Solenoids 15 mm NC, food industry version

(Note! Mounting screws included in basic valve)

Voltage	Weight Kg	Order code Without manual override	Weight Kg	Order code Override, blue, non locking flush	Weight Kg	Order code Override, yellow, locking flush	
	24 VDC	0,038	0,038	P2E-QV32C1	0,038	P2E-QV32C2	
	48 VDC	0,038	0,038	P2E-QV32D1	0,038	P2E-QV32D2	
	24 VAC 50Hz	0,038	0,038	P2E-QV31C1	0,038	P2E-QV31C2	
	48 VAC 50/60Hz	0,038	0,038	P2E-QV34D1	0,038	P2E-QV34D2	
	115 V 50Hz/ 120 V 60Hz	0,038	0,038	P2E-QV31F1	0,038	P2E-QV31F2	
	230 VAC 50Hz/ 240 VAC 60Hz	0,038	0,038	P2E-QV31J1	0,038	P2E-QV31J2	
	Weight						
	24 VDC			0,038	P2E-QV32C3	0,038	P2E-QV32C4
	24 VAC 50Hz			0,038	P2E-QV31C3	0,038	P2E-QV31C4
	115 VAC 50 Hz			0,038	P2E-QV31F3	0,038	P2E-QV31F4
230 VAC 50 Hz			0,038	P2E-QV31J3	0,038	P2E-QV31J4	

In accordance with the EU Machine Directive, EN 983, solenoid valves with manual override should have spring-return operating arms for safety.

Solenoid operators - CNOMO

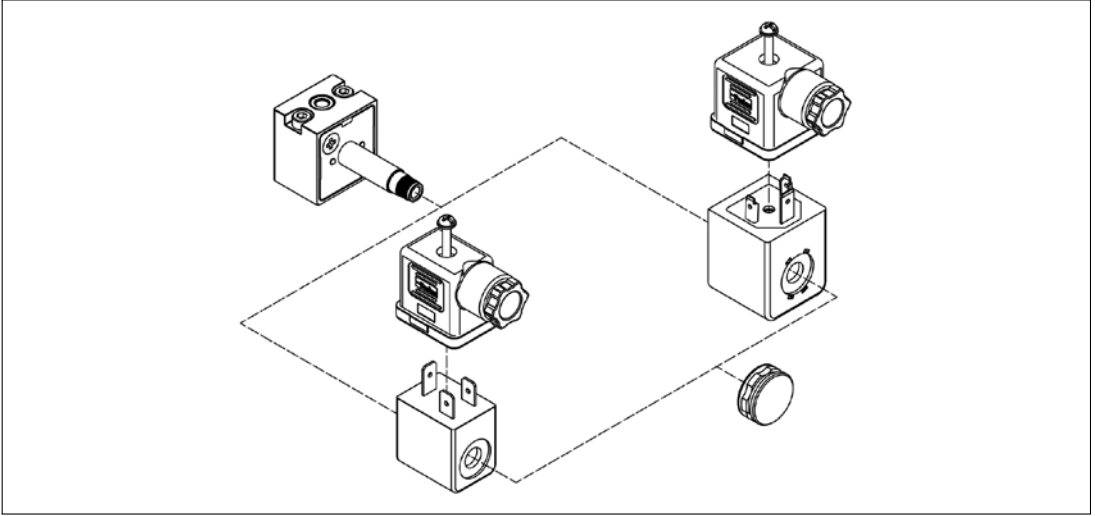

CNOMO Solenoid pilot options

The P2F P23*** (NC) 3/2 solenoid pilot operators are designed for piloting pneumatic control valves with compressed air or inert gases.

The P2F P operator is available for operating pressures up to 10 bar having an outlet orifice 1,3 mm and exhaust orifice 1,5 mm. Alternative operator are also available for an operating pressure up to 16 bar, or for a wide band voltage tolerance requires for mobile application.

Metal CNOMO Solenoid pilot for railway

An alternative operator, metal casting is also available for heavy duty or railway applications.

This P2F P operator is available for operating pressures up to 10 bar having an outlet orifice 1,3 mm and exhaust orifice 1,5 mm, and compatible with a wide range of coil, having a wide band voltage tolerance.

Corrosion resistant design

The pilot operator body is manufactured in thermoplastic PA 6.6 material and the core tube brass/stainless steel. The plunger/core is made from stainless steel and the valve seats from FKM.

Coils

Coils are wound with enameled copper wire, class H temperature class F insulation (155°C) and are encapsulated in Thermoplastic. When fitted with suitable connector and correct gasket they give protection to IP65.

Solenoid Pilot Exhaust

These operators all exhaust out of the top of the core tube which is tapped M5. The standard solenoid nut fitted to the core tube is the Diffuser nut which allows the exhaust to escape to atmosphere. This nut also minimises ingress of dirt into the valve through this port. The alternative plastic knurled nut can be specified (refer to part number system) if the exhaust air needs to be captured and piped away using the M5 tapped port.

Mobile Applications

ISO valves are tested to +5g shock and vibration. Solenoid operated valves are designed to operate with extended voltage tolerance bands within the ambient temperature ranges stated in the technical section.

Manual Override options

The pilot operators can be supplied with or without manual override. The standard manual override is the monostable (spring return) flush brass override. Alternatively the bistable (locking) override can be specified as an alternative for the Normal duty 10bar option.

Spares

Solenoid operators are available as spares complete with mounting screws. Coils and connectors should be ordered separately.

Solenoid operators - CNOMO

Order key

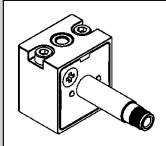
P	2	F	P	2	3	N	4	C		
Operator Type				Pressure / Temp				Manual / Override		
2				M				A		Without manual override
CNOMO 22 x 30 Plastic				10 bar / -25°C to +50°C				B		Non locking - monostable - Flush - Brass
4				N				C		Locking - bistable - Flush - Plastic
CNOMO 22 x 30 Metal				10 bar / -10°C to +50°C						

Note: 'C' only suitable for 'N' Pressure / Temp

Technical data - Solenoid operators, coil combinations

	NC Normal Operator with 30 x 30 standard coil	NC Normal Operator with 22 x 30 standard coil	NC Mobile Metal Operator with 30 x 30 Railway or mobile coil
Working pressure	0 to 10 bar	0 to 10 bar	0 to 10 bar
Ambient temperature	-10 °C to 60 °C (1)	-10 °C to 60 °C (1)	-25 °C to 60 °C (1)
Orifice	1.3/1.5mm	1.3/1.5mm	1.2/1.3mm
Flow Qn	0.84 dm³/s	0.84 dm³/s	0.7 dm³/s
Power (DC)	2.7W	4.8W	6.8W
Power (AC)	4.9VA	8.5VA	10.5VA
Voltage tolerance	+/- 10%	+/- 10%	+/- 30%
Pull in voltage			According to VDE 0580 July 2000
Duty cycle	100%	100%	100%
Insulation class	F	F	F
Electric connection	Din A	Industrial	Din A
Protection	IP65	IP65	IP65
Shock & Vibration			IEC 61373 Cat 1 Class B
Approval	CSA CUS		
Working media	All neutral media such as compressed air and inert gases.		

(1) limited to 50°C if use with 100% duty cycle and max voltage.

Mobile applications

Solenoid operated ISO valves for Mobile applications are fitted with the P2FP43M4A solenoid pilot operator. It has a 22x30 footprint with 1.2/1.3 orifice and will accept 22mm or 30mm coil options. The choice of coil option will depend on the voltage tolerance. Use the technical data in the table above before selecting the coil type required, or contact our technical department.

Transients

Interrupting the current through the solenoid coil produces momentary voltage peaks which, under unfavourable conditions, can amount to several hundred times the rated operating voltage. Normally, these transients do not cause problems, but to achieve the maximum life of relays in the circuit (and particularly of transistors, thyristors and integrated circuits) it is desirable to provide protection by means of voltage-dependent resistors (varistors). All connectors/cable plugs EN175301-803 with LED's include this type of circuit protection.

Materials

Pilot Valve	Standard	Mobile
Body:	Polyamide	Aluminium
Armature tube:	Brass	Stainless steel
Plunger & core:	Corrosion resistant Cr-Ni steel	
Seals:	FKM (Viton™)	Low temp FKM
Screws:	Zinc plated	Stainless steel

Coil

Encapsulation material: Thermoplastic as standard
thermoset resin for M12 connection

Control Devices

Solenoid coils with Din A or Industrial connection

Voltage	Order code Din A Standard 30 x 30	Weight (Kg)	Order code Din A Mobile 30 x 30	Weight (Kg)	Order code Industrial standard 22 x 30	Weight (Kg)
Direct current						
12V DC	P2FCA445	0.105	P2FCA447	0.105	P2FCB445	0.093
24V DC	P2FCA449	0.105	P2FCA448	0.105	P2FCB449	0.093
48V DC	P2FCA453*	0.105	P2FCA474	0.105	P2FCB451	0.093
72V DC			P2FCA470	0.105		
96V DC			P2FCA471	0.105		
110V DC			P2FCA472	0.105		
Alternative current						
12V 50/60Hz	P2FCA440	0.105			P2FCB440	0.093
24V 50/60Hz	P2FCA442	0.105			P2FCB442	0.093
48V 50/60Hz	P2FCA469#	0.105				
110V 50Hz, 120V 60Hz	P2FCA453	0.105			P2FCB453	0.093
230V 50Hz, 230V 60Hz	P2FCA457	0.105			P2FCB457	0.093

* P2FCA453 is compatible with 110 V AC and 48 V DC

P2FCA469 is 24 V DC 6.8W or 48 V 50Hz 9.9 VA

Solenoid coils with M12 connection

Voltage	Order code 30 x 30	Weight (Kg)	Order code 22 x 30	Weight (Kg)
Direct current				
24V DC	P2FC6419	0.065	P2FC7419	0.065

Spare Solenoid Nuts

Valves requiring captured exhaust should be fitted with plastic knurled nut

Order code

P2FNP

Valves with vented exhaust are fitted with diffuser plastic nut

Order Code

P2FND

Spare Solenoid Operators

Solenoid pilot operator CNOMO NC



Description	Order code No manual override	Weight (Kg)	Order code Non-lock manual override	Weight (Kg)	Order code Locking manual override	Weight (Kg)
Standard duty	P2FP23N4A	0.065	P2FP23N4B	0.065	P2FP23N4C	0.065
Mobile metal	P2FP43M4A	0.1				

Note.

Solenoid pilot operators are fitted to the Viking valve range. Order the above part numbers for spares. The operators are supplied with mounting screws and interface 'O' rings.

Coils and connectors must be ordered separately.

Solenoid Connectors / Cable Plugs EN175301-803

	Description	Order code 15mm Form C/ISO15217	Order code 22mm Industrial Form B	Order code 30mm Form A/ISO4400
With large headed screw suitable for mounting in inaccessible or recess position 	Standard IP65	P8C-C		
	24V DC LED and protection IP65	P8C-C26C		
	110V AC LED and protection IP65	P8C-C21E		
With standard screw 	Standard IP65 without flying lead	P8C-D	3EV10V10	3EV290V10
	With LED and protection 24V AC/DC	P8C-D26C	3EV10V20-24	3EV290V20-24
	With LED and protection 110V AC	P8C-D21E	3EV10V20-110	3EV290V20-110
	With LED and protection 230V AC		3EV10V20-230	3EV290V20-230
With cable 	Standard with 2m cable IP65	P8L-C2		
	Standard with 5m cable IP65	P8L-C5		
	24V AC/DC, 2m cable LED and protection IP65	P8L-C226C		
	24V AC/DC, 5m cable LED and protection IP65	P8L-C526C	3EV10V20-24L5	3EV290V20-24L5
	24V AC/DC, 10m cable LED and protection IP65	P8L-CA26C		
	110V AC/DC, 2m cable LED and protection IP65	P8L-C221E		
	110V AC/DC, 5m cable LED and protection IP65	P8L-C521E	3EV10V20-110L5	3EV290V20-110L5
	230V AC, 5m cable LED and protection IP65		3EV10V20-230L5	3EV290V20-230L5

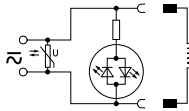
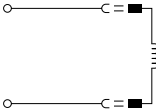

S

P8C-C	P8C-D26C	P8L-C226C
P8C-D	P8C-D21E	P8L-C526C
P8L-C2	P8C-C26C	P8L-CA26C
P8L-C5	P8C-C21E	P8L-C221E
3EV10V10		P8L-C521E
	3EV10V20-24	3EV10V20-24L5
	3EV10V20-110	3EV10V20-110L5
	3EV10V20-230	3EV10V20-230L5

Cable Plug Dimensions (mm)

Solenoid operators P2E - 15mm

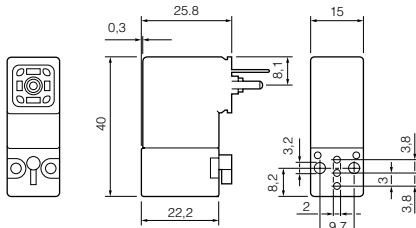

Solenoid operators P2F - CNOMO - 22 x 30mm

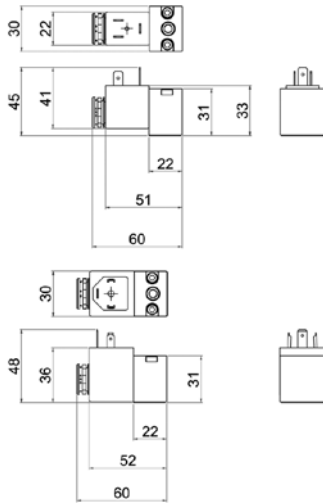

Cable plugs

- P8L-C2
- P8LC5
- P8L-C226C
- P8L-C526C
- P8L-CA26C
- P8L-C221E
- P8L-C521E

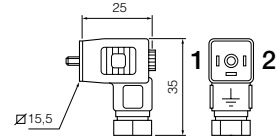

Cable plugs

- P8C-C
- P8C-C26C
- P8C-C21E
- P8C-D
- P8C-D26C
- P8C-D21E

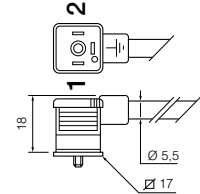

Cable plugs

- 3EV10V10

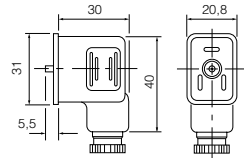

Cable plugs

- 3EV290V10

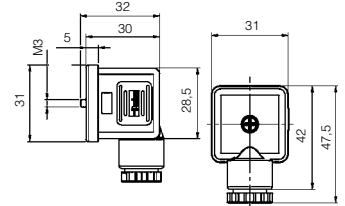

Accessories

Silencers

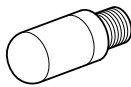

Port	Ordercode	Pack Qty
G1/8	P6M-PAB1	10
G1/4	P6M-PAB2	10
G3/8	P6M-PAB3	10
G1/2	P6M-PAB4	10

Fittings

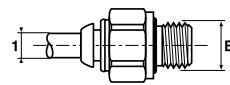

Male connector - BSPP

Tube dia 1	Thread B	Ordercode	Box Qty
4	1/8	F4PMB4-1/8	20
4	1/8	F4PMB4-1/8	20
6	1/8	F4PMB6-1/8	30
8	1/8	F4PB8-1/8	40
6	1/4	F4PMB6-1/4	30
8	1/4	F4PB8-1/4	30
10	1/4	F4PB10-1/4	20
12	1/4	F4PB12-1/4	10
8	3/8	F4PB8-3/8	20
10	3/8	F4PB10-3/8	20
12	3/8	F4PB12-3/8	10
14	3/8	F4PB14-3/8	10
10	1/2	F4PB10-1/2	10
12	1/2	F4PB12-1/2	10
14	1/2	F4PB14-1/2	10

Air Preparation & Airline Accessories

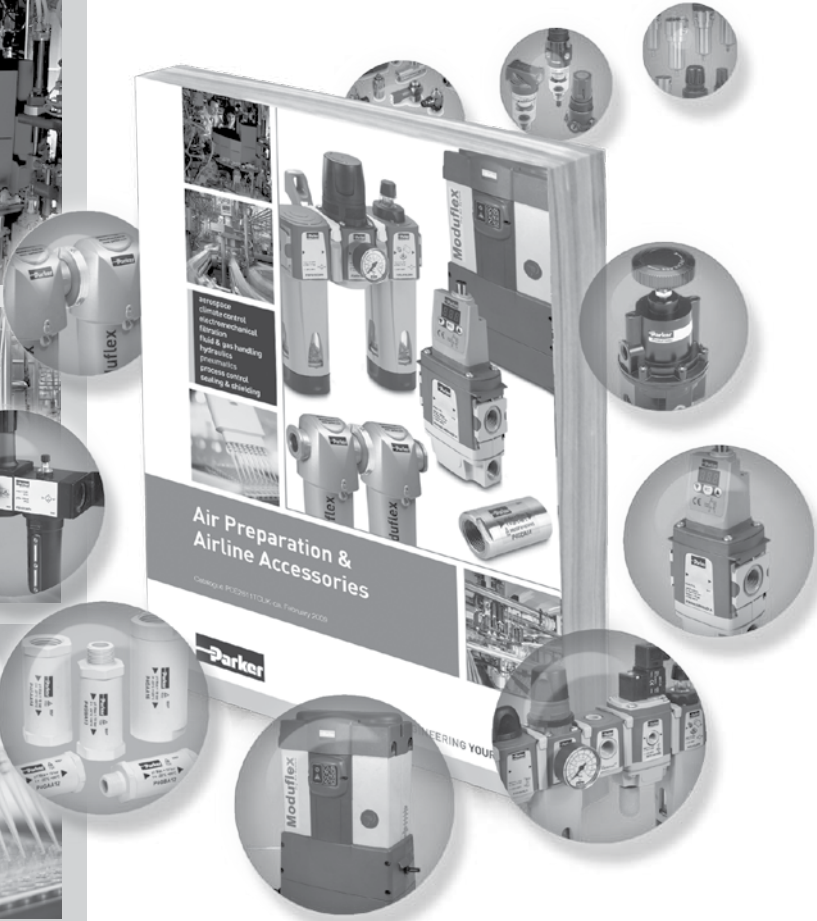

Parker is the world leader in motion and control technologies, providing systematic, precision-engineered solutions for a wide variety of, industrial markets. Throughout the world, Parker Hannifin is working together with companies to make their machines more reliable and more productive. Parker products are in operation on satellites orbiting the earth: in machine tools and mobile plant; on oil rigs and refineries; in hospitals and laboratories. In fact, wherever there

are machines that depend on motion or fluid control, you will find innovative and reliable Parker components and systems.

Global Air Preparation System



- Space saving integral gauge (P31 size only)
- Manifold style regulators available
- OSHA compliant shut-off valves
- Soft-Start & Quick Dump valves
- Electronic Proportional Regulator

Moduflex Dry Air System



- Designed in accordance with ASME VIII Div.1, approved to CSA/UL/CRN and fully CE Marked
- (PED, EMC, LVD) as standard.
- Flexible installation utilising the multiple in-line inlet & outlet connection ports.
- Can be Floor, Bench or Wall/Canopy mounted.
- Noise level less than 70dB(A).

Stainless Steel FRLs



- 316 Stainless steel FRL design to withstand harsh, corrosive environments
- Suitable for Marine & Offshore applications
- Chemical / Petroleum and process industries
- Coalescing filters are designed for removing oil and water aerosols down to 0.01µ

Moduflex Proportional Technology



- Very fast response times
- Accurate output pressure
- Micro parameter settings
- Selectable I/O parameters
- Quick, full flow exhaust.
- LED display indicates output pressure
- Auto enable function

Moduflex AirGuard Protection System



- Maintenance friendly, Repair possible while plant is still operating.
- Reliable and tamperproof, No adjustment necessary.
- Complies with EU current standard EN 983 - § 5.3.4.3.2.
- Complies with the 2009 ISO4414 (5.4.5.11.1)

P3N 1" Modular Hi Flow FRLs



- Self relieving feature plus balanced poppet provides quick response and accurate pressure regulation.
- Port blocks available to provide G3/4 and G11/2 port extension to G1 ported bodies.
- Proportional oil delivery over a wide range of air flows

Moduflex Compressed Air Filters



- Tested in accordance with ISO 8573.9
- High liquid removal efficiencies at all flow conditions
- Low pressure losses for low operational costs
- Multiple port sizes for a given flow rate provides increased flexibility during installation
- Suitable for variable flow compressors

Miniature FRL Series



- Compact body ported units.
- Port sizes G1/8 and G1/4.
- Unique deflector plate ensuring maximum water and particulate removal.
- Solid control piston with lip seal for extended life.
- Proportional oil delivery over a wide range of air flows.

High Precision Regulators



- High repeatability
- High relief capacity on R220 model
- High flow capacity on R230 model

Rotary Actuator and Air Motor Products

A complete range of rotary actuator and air motor products

aerospace
 chemical process
 electronics/robotics
 filtration
 food & packaging
 hydraulics
 pharmaceuticals
 process control
 testing & vibration

Rotary Actuators and Air Motors
 A complete range of pneumatic Rotary Actuator and Air Motor components
 © Parker Hannifin Corporation, 2009

Parker
 ENGINEERING YOUR...

Parker is the world leader in motion and control technologies, providing systematic, precision-engineered solutions for a wide variety of, industrial markets. Throughout the world, Parker Hannifin is working together with companies to make their machines more reliable and more productive. Parker products are in operation on satellites orbiting the earth: in machine tools and mobile plant; on oil rigs and refineries; in hospitals and laboratories. In fact, wherever there are machines that depend on motion or fluid control, you will find innovative and reliable Parker components and systems.

The Parker range of rotary actuators and airmotors offers a choice of oscillating or continuous rotary motion. Stainless steel versions specifically for food industry or more robust models for general industrial applications are available.

Rotary Actuator and Air Motor Products

Harsh Environments & Food Industry

P1V-S Air Motors



- All stainless steel design
- From 0.120kW - 1.2kW power
- For arduous applications
- Non-lube intermittent operation
- External seals viton
- Ideal for food industry applications.

Arduous Applications

P1V-B Large Vane Air Motors



- Power 5,1 kW, 9 kW and 18 kW
- For the very heavy applications
- Free speed from 400 up to 300 rpm
- High torque from 57 to 160 Nm by max output power

Packaging, Process, Electronic Applications

PRO-PRN Rotary Actuators



- Compact design
- Durable construction
- Long maintenance-free life
- High output torque/weight ratio
- Wide choice of torques available (up to 247 Nm)

Minimum Noise Level

P1V-P Radial Piston Air Motors



- P1V-P piston motor
- Power 0,73 kW, 0,125kW and 0,228kW
- Low speed and high torque
- Available as base and brake motors
- Free speed from 2200 down to 7,4 rpm
- High torque from 0,637Nm up to 500Nm

Arduous Applications

P1V-A Large Air Motors



- Designed for arduous applications.
- Wide range of optional gears
- Wide speed and torque range 1.6kW, 2.6kW, 3.6kW

Rack and Pinion Piston Rods

RA Rotary Actuators Rack & Pinion Type



- High torque
- Uniform torque in both directions
- Compact design
- 90° or 180° rotation
- Output shaft with key

Robust Air Motor

P1V-M Robust Vane Air Motors



- Power 0,2 kW, 0,4 kW and 0,6 kW
- Patented way for simple change of vanes
- Free speeds from 28 up to 10000 rpm
- Torque from 0,38 Nm up to 380NM by max output power
- Standard equipped with flange mounting
- Footmountings as accessories

Heavy Duty Applications

P5W Rotary Table Units



- Rack and pinion patented movement.
- Continuously adjustable stroke.
- Large ball bearings on the shaft.
- Through hole in the pinion.
- Optional rubber end stroke or hydraulic shock-absorber.
- Mid position stop (MPS)

Linear Actuator Products

A complete range of pneumatic actuators

Actuator Products
A complete range of pneumatic actuators
Catalogue PDC2612TCUK-ca, November 2008

Parker
ENGINEERING YOUR...

pneumatic
 electro-mechanical
 electro-hydraulic
 fluid & gas handling
 systems
 automation
 process control
 testing & analysis

Parker is the world leader in motion and control technologies, providing systematic, precision-engineered solutions for a wide variety of, industrial markets. Throughout the world, Parker Hannifin is working together with companies to make their machines more reliable and more productive. Parker products are in operation on satellites orbiting the earth; in machine tools and mobile plant; on oil rigs and refineries; in hospitals and laboratories. In fact, wherever there are machines that depend on motion or fluid control, you will find innovative and reliable Parker components and systems.

The Parker range of actuators encompasses both linear and rotary motion. Compact and lightweight designs, versions specifically for the food industry both in aluminium and stainless steel and products for arduous applications in harsh environments are all featured.

Minimum Space Applications

P1G Compact Cylinders



- Ø6, 10 & 16mm Bore sizes
- Non-lube operation
- Corrosion resistant design
- Integral mounting thread
- Compact construction
- Single acting as standard.

Clamping & Locking Operations

C05 Short Stroke Cylinders



- Ø8 - 63mm bore sizes
- Short stroke providing high clamping force
- Compact dimensions for confined spaces
- Single and double acting
- Simple installation and mounting.

Light Duties in Packaging, Food and Textile

P1A Mini ISO Cylinders



- Ø10 - 25mm Bore size to ISO 6432
- Magnetic piston as standard
- End stroke buffers for long service life
- Adjustable cushioning Ø16 - 25mm Bore sizes
- Complete range of mountings & sensors
- Piston rod guidance units available.

Confined Space Applications

P1J Compact Cylinders



- Ø12 - 63mm
- Stroke lengths up to 100mm
- Single and double acting
- Magnetic piston as standard
- Compact dimensions for confined spaces
- Complete range of mountings & sensors.

Flexible Porting Options

P1M Cylinders



- Ø12 - 100mm
- Stroke lengths up to 500mm
- Single and double acting
- Magnetic piston as standard
- Flexible porting options
- Complete range of mountings & sensors.

Harsh Environments / Food Industry

P1S Stainless Steel Cylinders



- All stainless steel design
- Mini ISO 6432 Ø10 - 25mm Bore sizes
- Standard ISO 6431 Ø32 - 125mm Bore sizes
- Magnetic piston as standard
- Clean design ideal for washdown
- Adjustable end cushioning.
- Initial lubrication with food grade grease.

Resistance to Side Load

P5T Compact Cylinders

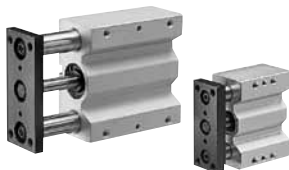

- Ø12 - 100mm bore size
- Complete cylinder with integral guidance
- Plain bearing or twin recirculating bearings
- End stop cushioning as standard
- Magnetic as standard
- Flexible porting and mounting
- Standard strokes 10 - 200mm

Light Duty Applications

P1K Cylinders



- Ø32 - 125mm Bore sizes
- Single and double acting
- Clean line profile design
- Designed for dry piston rod operation
- End stroke buffers for long service life
- Position sensing versions.

Short Stroke, High Thrust Single Acting Applications

Air Bellows



- 10 sizes Ø70 - 660mm
- Strokes from 45 - 430mm
- High thrust frictionless movement
- Single, double or triple convolutions
- Maintenance free.

General Industrial & Food Industry Versions

P1D ISO/VDMA Cylinders



- Ø32 - 125mm Bore size ISO/VDMA standard
- Double acting with adjustable end cushioning
- Magnetic piston as standard
- Flexible porting option
- Non-lube operation
- 'Clean' version for food industry
- Complete range of sensors and mountings

Clamping & Tightening

Hydraulic Clamp Cylinders



- Single acting cylinders with built-in hydro-pneumatic intensifier
- Compact size with large clamping forces up to 2700 daN (depending on air pressure)
- Operated using a compressed air supply, no special installation required
- Easy adjustment through a fully threaded body
- Simple and rapid installation

Gripping for most applications

P5G-C Robotic Grippers



- 4 sizes available
- Parallel or angular action
- Square jaw carriers
- One or two magneto-inductive sensor can be mounted on all sizes to provide signal to monitor gripper opening and closing.

Demanding Environments

P1E VDMA 24562 Cylinders



- Ø160 - 200mm Bore sizes VDMA standard
- Double acting with adjustable end cushioning
- Magnetic piston as standard
- Non-lube operation
- Tie rod construction
- Complete range of mountings & sensors.

Wide Variety of Industrial Applications

PV Rotary Actuators - Vane Type



- Double acting actuators
- Single or double vane
- Compact smooth design
- Uniform torque in both directions
- Angle adjustment and sensors available.

Hydraulic Damping Cylinder

Hydrockecks



- Range of imperial sizes
- Gives smooth control feeds
- Strokes up to 450mm

Door Actuation, Special Purpose Machinery

Rodless Cylinders



- High precision cushioning
- Flexible porting
- High efficiency sealing technology
- Integral sensor slot with enhancement strip
- Heavy load carrying capability

Clamping, Riveting & Punching Applications

C0D - C0P Thrust Cylinders



- Short stroke high thrust design
- Compact dimensions
- Diaphragm or piston versions
- Single or double acting.

Chip Mounting, Glass, Injection Mold, Sheet Metal

Vacuum



- Mini vacuum generators
- Compact "air saver" vacuum generators
- Multi-function vacuum generators with holding
- Valve and rapid release options
- Wide range of suction cups
- Wide range materials

At Parker, we're guided by a relentless drive to help our customers become more productive and achieve higher levels of profitability by engineering the best systems for their requirements. It means looking at customer applications from many angles to find new ways to create value. Whatever the motion and control technology need, Parker has the experience, breadth of product and global reach to consistently deliver. No company knows more about motion and control technology than Parker. For further info call 00800 27 27 5374.



AEROSPACE

- Key Markets**
- Aircraft engines
 - Business & general aviation
 - Commercial transports
 - Land-based weapons systems
 - Military aircraft
 - Missiles & launch vehicles
 - Regional transports
 - Unmanned aerial vehicles

- Key Products**
- Flight control systems & components
 - Fluid conveyance systems
 - Fluid metering delivery & atomization devices
 - Fuel systems & components
 - Hydraulic systems & components
 - Inert nitrogen generating systems
 - Pneumatic systems & components
 - Wheels & brakes



CLIMATE CONTROL

- Key Markets**
- Agriculture
 - Air conditioning
 - Food, beverage & dairy
 - Life sciences & medical
 - Precision cooling
 - Processing
 - Transportation

- Key Products**
- CO₂ controls
 - Electronic controllers
 - Filter driers
 - Hand shut-off valves
 - Hose & fittings
 - Pressure regulating valves
 - Refrigerant distributors
 - Safety relief valves
 - Solenoid valves
 - Thermostatic expansion valves



ELECTROMECHANICAL

- Key Markets**
- Aerospace
 - Factory automation
 - Food & beverage
 - Life science & medical
 - Machine tools
 - Packaging machinery
 - Paper machinery
 - Plastics machinery & converting
 - Primary metals
 - Semiconductor & electronics
 - Textile
 - Wire & cable

- Key Products**
- AC/DC drives & systems
 - Electric actuators
 - Controllers
 - Gantry robots
 - Gearheads
 - Human machine interfaces
 - Industrial PCs
 - Inverters
 - Linear motors, slides and stages
 - Precision stages
 - Stepper motors
 - Servo motors, drives & controls
 - Structural extrusions



FILTRATION

- Key Markets**
- Food & beverage
 - Industrial machinery
 - Life sciences
 - Marine
 - Mobile equipment
 - Oil & gas
 - Power generation
 - Process
 - Transportation

- Key Products**
- Analytical gas generators
 - Compressed air & gas filters
 - Condition monitoring
 - Engine air, fuel & oil filtration & systems
 - Hydraulic, lubrication & coolant filters
 - Process, chemical, water & microfiltration filters
 - Nitrogen, hydrogen & zero air generators



FLUID & GAS HANDLING

- Key Markets**
- Aerospace
 - Agriculture
 - Bulk chemical handling
 - Construction machinery
 - Food & beverage
 - Fuel & gas delivery
 - Industrial machinery
 - Mobile
 - Oil & gas
 - Transportation
 - Welding

- Key Products**
- Brass fittings & valves
 - Diagnostic equipment
 - Fluid conveyance systems
 - Industrial hose
 - PTFE & PFA hose, tubing & plastic fittings
 - Rubber & thermoplastic hose & couplings
 - Tube fittings & adapters
 - Quick disconnects



HYDRAULICS

- Key Markets**
- Aerospace
 - Aerial lift
 - Agriculture
 - Construction machinery
 - Forestry
 - Industrial machinery
 - Mining
 - Oil & gas
 - Power generation & energy
 - Truck hydraulics

- Key Products**
- Diagnostic equipment
 - Hydraulic cylinders & accumulators
 - Hydraulic motors & pumps
 - Hydraulic systems
 - Hydraulic valves & controls
 - Power take-offs
 - Rubber & thermoplastic hose & couplings
 - Tube fittings & adapters
 - Quick disconnects



PNEUMATICS

- Key Markets**
- Aerospace
 - Conveyor & material handling
 - Factory automation
 - Food & beverage
 - Life science & medical
 - Machine tools
 - Packaging machinery
 - Transportation & automotive

- Key Products**
- Air preparation
 - Compact cylinders
 - Field bus valve systems
 - Grippers
 - Guided cylinders
 - Manifolds
 - Miniature fluidics
 - Pneumatic accessories
 - Pneumatic actuators & grippers
 - Pneumatic valves and controls
 - Rodless cylinders
 - Rotary actuators
 - Tie rod cylinders
 - Vacuum generators, cups & sensors



PROCESS CONTROL

- Key Markets**
- Chemical & refining
 - Food, beverage & dairy
 - Medical & dental
 - Microelectronics
 - Oil & gas
 - Power generation

- Key Products**
- Analytical sample conditioning products & systems
 - Fluoropolymer chemical delivery fittings, valves & pumps
 - High purity gas delivery fittings, valves & regulators
 - Instrumentation fittings, valves & regulators
 - Medium pressure fittings & valves
 - Process control manifolds



SEALING & SHIELDING

- Key Markets**
- Aerospace
 - Chemical processing
 - Consumer
 - Energy, oil & gas
 - Fluid power
 - General industrial
 - Information technology
 - Life sciences
 - Military
 - Semiconductor
 - Telecommunications
 - Transportation

- Key Products**
- Dynamic seals
 - Elastomeric O-rings
 - EMI shielding
 - Extruded & precision-cut, fabricated elastomeric seals
 - Homogeneous & inserted elastomeric shapes
 - High temperature metal seals
 - Metal & plastic relaxed composite seals
 - Thermal management

**Need
something ?**

It's



Using the Technical Catalogue CD

If you already have Adobe Acrobat 4.0
Insert the CD into your PC
Click on Parker Pneumatic PDF and the CD will run.
On the opening page are displayed the options available.

On the opening page are displayed the options available.

- 1. Search.** You may search by Part Number, Name or Product type.
- 2. Getting Started.** This displays a guide to Adobe Acrobat 4.0.
- 3. View Bookshelf.** Simple to use navigation, click on the product type and the overview of all products in that type will open. Click on the product you require and the Technical Catalogue will be displayed
- 4. Exit**
- 5. Contact us.** Lists the main Sales Offices around Europe with Telephone and Fax numbers

Using the Technical Catalogue CD, If you do not have Adobe Acrobat 4.0.

We recommend viewing this CD in Adobe Acrobat 4.0.
If you do not have Adobe Acrobat 4.0 it is available free on the CD for you to install. You will need to un-install older versions of Adobe Acrobat prior to installing version 4.0. Insert the CD into your PC
Click on Parker Pneumatic PDF and the CD will run.

Parker Worldwide

AE – UAE, Dubai
Tel: +971 4 8127100
parker.me@parker.com

AR – Argentina, Buenos Aires
Tel: +54 3327 44 4129

AT – Austria, Wiener Neustadt
Tel: +43 (0)2622 23501-0
parker.austria@parker.com

AT – Eastern Europe, Wiener Neustadt
Tel: +43 (0)2622 23501 900
parker.easteurope@parker.com

AU – Australia, Castle Hill
Tel: +61 (0)2-9634 7777

AZ – Azerbaijan, Baku
Tel: +994 50 2233 458
parker.azerbaijan@parker.com

BE/LU – Belgium, Nivelles
Tel: +32 (0)67 280 900
parker.belgium@parker.com

BR – Brazil, Cachoeirinha RS
Tel: +55 51 3470 9144

BY – Belarus, Minsk
Tel: +375 17 209 9399
parker.belarus@parker.com

CA – Canada, Milton, Ontario
Tel: +1 905 693 3000

CH – Switzerland, Etoy
Tel: +41 (0)21 821 87 00
parker.switzerland@parker.com

CL – Chile, Santiago
Tel: +56 2 623 1216

CN – China, Shanghai
Tel: +86 21 2899 5000

CZ – Czech Republic, Klecany
Tel: +420 284 083 111
parker.czechrepublic@parker.com

DE – Germany, Kaarst
Tel: +49 (0)2131 4016 0
parker.germany@parker.com

DK – Denmark, Ballerup
Tel: +45 43 56 04 00
parker.denmark@parker.com

ES – Spain, Madrid
Tel: +34 902 330 001
parker.spain@parker.com

FI – Finland, Vantaa
Tel: +358 (0)20 753 2500
parker.finland@parker.com

FR – France, Contamine s/Arve
Tel: +33 (0)4 50 25 80 25
parker.france@parker.com

GR – Greece, Athens
Tel: +30 210 933 6450
parker.greece@parker.com

HK – Hong Kong
Tel: +852 2428 8008

HU – Hungary, Budapest
Tel: +36 1 220 4155
parker.hungary@parker.com

IE – Ireland, Dublin
Tel: +353 (0)1 466 6370
parker.ireland@parker.com

IN – India, Mumbai
Tel: +91 22 6513 7081-85

IT – Italy, Corsico (MI)
Tel: +39 02 45 19 21
parker.italy@parker.com

JP – Japan, Tokyo
Tel: +81 (0)3 6408 3901

KR – South Korea, Seoul
Tel: +82 2 559 0400

KZ – Kazakhstan, Almaty
Tel: +7 7272 505 800
parker.easteurope@parker.com

MX – Mexico, Apodaca
Tel: +52 81 8156 6000

MY – Malaysia, Shah Alam
Tel: +60 3 7849 0800

NL – The Netherlands, Oldenzaal
Tel: +31 (0)541 585 000
parker.nl@parker.com

NO – Norway, Asker
Tel: +47 66 75 34 00
parker.norway@parker.com

NZ – New Zealand, Mt Wellington
Tel: +64 9 574 1744

PL – Poland, Warsaw
Tel: +48 (0)22 573 24 00
parker.poland@parker.com

PT – Portugal, Leca da Palmeira
Tel: +351 22 999 7360
parker.portugal@parker.com

RO – Romania, Bucharest
Tel: +40 21 252 1382
parker.romania@parker.com

RU – Russia, Moscow
Tel: +7 495 645-2156
parker.russia@parker.com

SE – Sweden, Spånga
Tel: +46 (0)8 59 79 50 00
parker.sweden@parker.com

SG – Singapore
Tel: +65 6887 6300

SK – Slovakia, Banská Bystrica
Tel: +421 484 162 252
parker.slovakia@parker.com

SL – Slovenia, Novo Mesto
Tel: +386 7 337 6650
parker.slovenia@parker.com

TH – Thailand, Bangkok
Tel: +662 717 8140

TR – Turkey, Istanbul
Tel: +90 216 4997081
parker.turkey@parker.com

TW – Taiwan, Taipei
Tel: +886 2 2298 8987

UA – Ukraine, Kiev
Tel: +380 44 494 2731
parker.ukraine@parker.com

UK – United Kingdom, Warwick
Tel: +44 (0)1926 317 878
parker.uk@parker.com

US – USA, Cleveland
Tel: +1 216 896 3000

VE – Venezuela, Caracas
Tel: +58 212 238 5422

ZA – South Africa, Kempton Park
Tel: +27 (0)11 961 0700
parker.southafrica@parker.com

European Product Information Centre
Free phone: 00 800 27 27 5374
(from AT, BE, CH, CZ, DE, EE, ES, FI, FR, IE, IL, IS, IT, LU, MT, NL, NO, PT, SE, SK, UK)

