

Manguera hidráulica, terminales y equipo

Catálogo



ER Hidráulica, S.L.
Hidráulica y Neumática

Índice

Soluciones orientadas al cliente	3
Sobre E.R. HIDRAÚLICA	4
Propuesta de valor	6
Componentes para Hidráulica, Neumática	7
Identificadores	9
Mangueras	20
Racores Italianos	35
Racores Serie 16	44
Racores Serie 26	55
Racores Serie 48	58
Racores Serie 70	112
Racores Serie 73	135
Racores Serie 77	159
Racores Serie V4/V6	187
Adaptadores	217
Enchufes rápidos y válvulas	249
Máquinas	252
Certificación E.R. HIDRAÚLICA	266

Soluciones orientadas al cliente



HOSE DOCTOR®

servicio de reparación de manguera in situ

Mercados industriales atendidos:

- Atracciones de feria y simuladores
- Empacadoras y compactadoras
- Prensas hidráulicas
- Maquinaria industrial
- Automoción en planta
- Máquina herramienta
- Aplicaciones marinas
- Equipo médico
- Petróleo y gas
- Papel
- Plásticos y caucho
- Generación de energía
- Máquinas de ensayo

Soluciones orientadas al cliente

Parker Hydraulics ofrece "soluciones" con la mayor variedad de productos y servicios del mercado. Los clientes pueden estar seguros de que nadie conoce la hidráulica industrial como nuestros ingenieros de aplicaciones y diseño, equipos de innovación y especialistas en soluciones de sistemas. Nuestros clientes pueden reducir su número de proveedores sin arriesgar la integridad de los productos. Y comprando todo en un mismo proveedor se ahorra tiempo y dinero, a la vez que se facilita la tramitación de pedidos y se reduce el plazo de entrega.

Productos hidráulicos y neumáticos para cualquier aplicación

En el corazón de todas las soluciones hidráulicas industriales está el prestigio de Parker en innovación y fabricación de calidad, adquirido a lo largo de 75 años. Nadie está mejor posicionado para satisfacer sus necesidades. Parker tiene en stock más de 300.000 referencias de productos hidráulicos y neumática. Así pues, tanto si piensa diseñar nuevas aplicaciones o rediseñar aplicaciones existentes, podemos satisfacer cualquier necesidad de componentes hidráulicos y neumático.

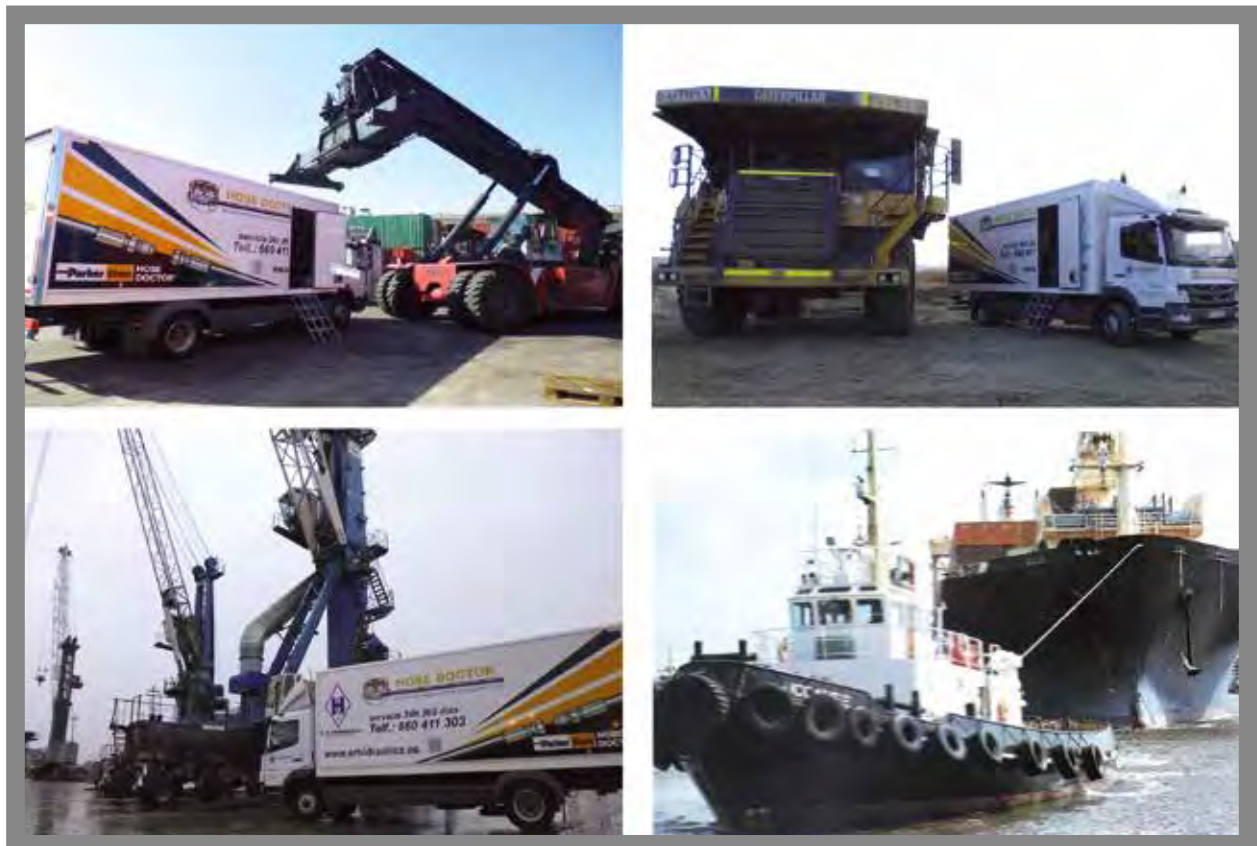

E.R. HIDRÁULICA, S.L.

E.R.HIDRAULICA,S.L., Es una empresa técnica y dinámica que se constituyó en el **año 1992**. Sus comienzos en principio fueron para atender la demanda del mercado hidráulico en el sector de maquinaria agrícola de Andalucía.

En el año 1995 y gracias a la colaboración de nuestros proveedores (fabricantes de primera línea a nivel mundial), llevamos a cabo la introducción en el mercado industrial, proveyendo, diseñando, reparando y montando sistemas de oleohidráulica, neumática, filtración, proceso, etc. hoy contamos con la distribución de PARKER y con ello de todo su equipo de ingeniería, y comercial.



Estos cambios nos han llevado a ampliar nuestras instalaciones y nuestros departamentos internos, implantando para mejor control de calidad el sistema UNE-EN-ISO 9000-2000.

E.R.HIDRAULICA,S.L. apuesta fuerte y sistemáticamente por mejorar su sistema comercial y productivo incorporando el departamento de RR.HH y preparando técnicamente al personal con cursos, charlas sobre productos y reuniones para el seguimiento de calidad y presentación de artículos.



Para satisfacer todas sus necesidades industriales, contacte con:

Tel.: 954 358 451 - Sevilla

Tel.: 959 224 833 - Huelva



**24 horas
365 días al año
con el servicio
HOSE DOCTOR.**

*E.R. Hidráulica
apuesta fuerte y
sistemáticamente
por mejorar
su sistema comercial.*



E.R.HIDRAULICA,S.L, (Sevilla), cuenta con una estructura de 1500 m² de instalaciones donde concentra más de 40.000 referencias de artículos de forma permanente, así como la atención rápida al cliente, departamento comercial, departamento de administración, producción y departamento de RR.HH., maquinaria para fabricación de latiguillos, banco de pruebas estático y de impulsos de hasta 2000BAR de presión y laboratorio de partículas para aceite hidráulico.

E.R.HIDRAULICA,S.L, (Huelva), es nuestra nueva instalación, y cuenta con 500 m² de nave

con más de 10.000 referencias y una unidad móvil completa HOSE DOCTOR servicio 24 horas, 365 días al año.

Para mayor atención al cliente incorporamos dos unidades de taller de fabricación de latiguillos (HOSE DOCTOR), con un servicio 24 horas, 365 días al año, que resolverá todo tipo de incidencias in situ por estar dotadas de maquinaria y más de 1500 referencias en su contenido.



Servicio Hose Doctor

Servicio de recambio de manguera hidráulica in situ



Propuesta de valor



Sevilla



Huelva

Soporte y servicios:

En lo relativo a la hidráulica y neumática, la red mundial de ingenieros de ventas, Parker predica con el ejemplo. Nuestros ingenieros de ventas los mejor formados del sector, pueden ser su punto único de contacto para cualquier necesidad hidráulica, incluida la solución rápida de problemas. Todos son técnicos titulados que cultivan las relaciones a largo plazo. Y están a su disposición siempre que los necesite, un horario laboral o durante un fin de semana.

La ventaja competitiva de Parker en servicio a clientes se ha labrado con una red mundial de 12.000 distribuidores que pueden proporcionar productos y servicios Parker prácticamente en cualquier momento y lugar.

En los centros de Tecnología Parker encontrará: diseño y tecnología avanzados, inventario local y mundial, un equipo de ingenieros de sistemas, el mejor soporte técnico de la industria y formación.

Para satisfacer todas sus necesidades industriales, contacte con:

Tel.: 954 358 451 - Sevilla

Tel.: 959 224 833 - Huelva



**24 horas
365 días
al año**

E.R. Hidráulica y Parker son unos aliados para mejorar su productividad y rentabilidad.

Sean cuales sean sus necesidades, Parker es su proveedor único de todas las soluciones de control de movimiento.

Componentes de hidráulica, neumática vacío y conducción de fluidos

Unidades de potencia

Parker tiene la gama más completa de unidades de potencia hidráulica estándar y preadaptadas de la industria. Nuestros productos incluyen desde plataformas verticales de 20 litros hasta plataformas elevadas de 625 litros. También ofrecemos unidades de potencia personalizadas que se diseñan y fabrican de acuerdo con las especificaciones del cliente; estas unidades se pueden dotar de accesorios para casi cualquier aplicación, con la consiguiente comodidad de adquirir una unidad completa de calidad en un solo proveedor.

Todas las unidades de potencia Parker están respaldadas por un soporte técnico completo, incluida la documentación de control para usar en el taller. Además, la mayoría de las unidades de potencia incluidas en el catálogo de Parker se entregan en cinco días hábiles.

Cilindros

Parker es un fabricante líder de cilindros hidráulicos para aplicaciones de equipos industriales. Nuestros cilindros ofrecen las altas prestaciones que los clientes esperan de Parker: millones de ciclos sin problemas. Los cilindros Parker han demostrado ser los más fiables y rentables del mercado.

Válvulas y controles hidráulicos

Fabricamos válvulas de control hidráulico para prácticamente todas las aplicaciones de equipos industriales, desde simples funciones on/off hasta control de movimiento preciso. Incluyen válvulas apilables, para control de movimiento, control de presión y servoválvulas, así

como válvulas direccionales y proporcionales montadas en manifold.

Bloques colectores hidráulicos

Parker es líder mundial en diseño y fabricación de circuitos hidráulicos integrados. Ofrecemos soluciones para circuitos complejos seleccionando válvulas de cartucho roscadas de nuestra amplia gama de productos e integrándolas en un solo manifold. Utilizamos software 3D-CAD/CAM, centros de mecanizado de avanzada tecnología y exhaustivas pruebas automatizadas para maximizar el rendimiento de las aplicaciones.

Actuadores giratorios

Parker es líder de la industria en diseño y fabricación de actuadores giratorios de piñón y cremallera, con una salida de par de hasta 68.000 Nm. Además de la oferta estándar de actuadores giratorios, trabajamos con nuestros clientes para diseñar soluciones que satisfagan cualquier requisito específico. Los actuadores giratorios ofrecen un alto par constante para ejecutar una variedad de acciones, incluyendo movimientos basculantes, giros, inclinación, orientación, transferencia, mezcla, accionamiento de válvulas, tensado y sujeción. Las aplicaciones engloban máquinas-herramienta así como maquinaria de embalaje, aplicaciones marinas, metales primarios, caucho, plásticos y manipulación de materiales.

Acumuladores

Parker ofrece la gama más amplia de la industria de acumuladores hidráulicos y productos afines:

acumuladores de pistón, vejiga y diafragma, así como botellas de gas y otros accesorios. Estos componentes de eficacia probada mejoran el rendimiento de los sistemas hidráulicos manteniendo la presión, complementando el caudal de las bombas y absorbiendo los golpes del sistema. La robusta construcción garantiza años de servicio eficaz y fiable.

Filtración

Los productos de filtración Parker están diseñados para proteger los sistemas y componentes hidráulicos de los contaminantes del fluido y maximizar así su fiabilidad. Nuestra amplia gama de filtros para líneas de presión y retorno prolongan la vida útil de las máquinas y reducen el mantenimiento y los costes. Están disponibles filtros de alta, media y baja presión, así como carros de filtros portátiles, cartuchos de repuesto Parfit e instrumentos de análisis de fluidos.

Conectores para fluidos

Parker tiene una línea completa de productos y servicios de conexión de fluidos para sistemas hidráulicos y neumáticos. Los productos incluyen desde racores, válvulas y enchufes rápidos de máxima calidad hasta mangueras de presión disponibles en una amplia gama de materiales de tubo, diseños de refuerzo y cubiertas exteriores. Con nuestra red de distribución y centros de servicio ubicados estratégicamente en todo el mundo podrá obtener los productos adecuados en el momento y lugar que los necesite.

Servicios de valor añadido

ParkerStore, Servicio total de mangueras y racores



La primera tienda autoservicio para soluciones hidráulicas y neumáticas. Ofrece

- Una amplia gama de referencias en stock.
- Fabricación de latiguillos inmediata in-situ.
- Los expertos ParkerStore están formados y certificados por Parker, ellos siempre están disponibles para ayudar y ofrecer las mejores soluciones.

HOSE DOCTOR® –

Servicio de repuesto de manguera hidráulica



Este servicio de emergencia está disponible 24 horas al día y 7 días a la semana mediante línea telefónica gratuita. El Servicio HOSE DOCTOR® es un auténtico taller móvil con un stock de mangueras, terminales, adaptadores, enchufes rápidos y aceite hidráulico. El técnico es asimismo capaz de reemplazar cualquier flexible con fallo, rápidamente in-situ.

Parker® Tracking System – único como una huella



El Parker Tracking System es el camino más rápido para obtener flexibles de alta calidad

- Identificación rápida, precisa y segura del latiguillo
- Único como una huella
- El código Parker Tracking System de 8 dígitos permite trazabilidad
- Se aplica una etiqueta duradera a cada producto vendido, enlazando así los ParkerStores y clientes en todo el mundo

Si se necesita un repuesto ...

... simplemente ¡llame a su ParkerStore local!

- Para detalles sobre su ParkerStore más cercano contacte **008002727 5374** o **+44 (0) 1442 358 429** o visite nuestra página web **www.parker.com/pts**
- Haga saber dónde se encuentra usted y facilite el código de 8 dígitos Parker Tracking System
- El ParkerStore suministrará el flexible de recambio, **cuándo y dónde sea necesario**

IDENTIFICADORES



Identificación de los tipos de terminal

En general, los terminales se pueden identificar por su aspecto visual, su superficie de estanqueidad/tipo de estanqueidad o por su tipo/forma de rosca. En las páginas siguientes se muestra una identificación ocular autoexplicativa. No obstante, el mecanismo de estanqueidad y el método de identificación de roscas precisan una mayor explicación

Determinación de los mecanismos de estanqueidad:

- Superficie de la rosca
- Junta tórica
- Ángulo de asiento de metal con metal
- Ángulo de asiento con junta tórica

Superficie de la rosca

La estanqueidad queda asegurada por el aplastamiento de los bordes de las roscas cuando el terminal macho se rosca en el terminal hembra. Normalmente la parte frontal de los terminales machos es más estrecha que la parte trasera – denominadas a menudo roscas cónicas.

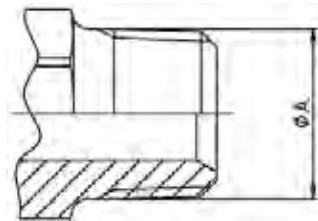

Junta tórica

La junta tórica del terminal macho se comprime contra el correspondiente terminal hembra y asegura la estanqueidad. Este tipo de mecanismo de estanqueidad debe ser la elección preferida para aplicaciones de alta presión.

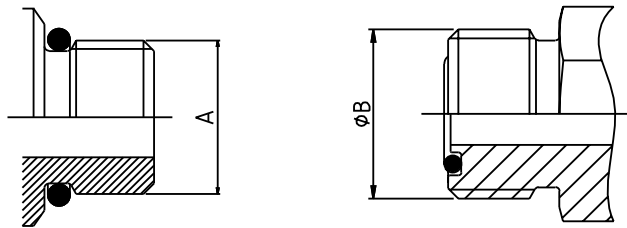

Ángulo de asiento de metal con metal

La junta tiene lugar donde coinciden las dos caras anguladas del terminal macho y del correspondiente terminal hembra, y son encajadas una en otra por el apriete de la tuerca. Las superficies de estanqueidad pueden ser convexas o cóncavas (asiento) en el terminal macho, o en la cabeza del tubo del terminal hembra, como se muestra.

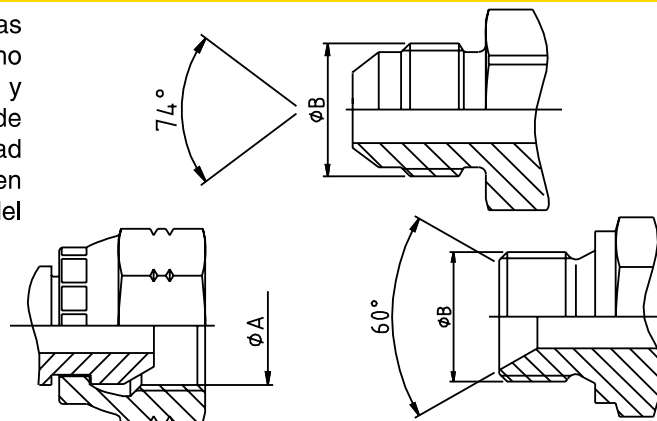

Ángulo de asiento con junta tórica

Estos terminales combinan la funcionalidad del ángulo de asiento con la junta tórica. La junta tórica está en la superficie de estanqueidad angulada del terminal, de modo que cuando se rosca el terminal macho y el hembra, las superficies de estanqueidad encajan juntas y deforman al mismo tiempo la junta tórica entre ellos.

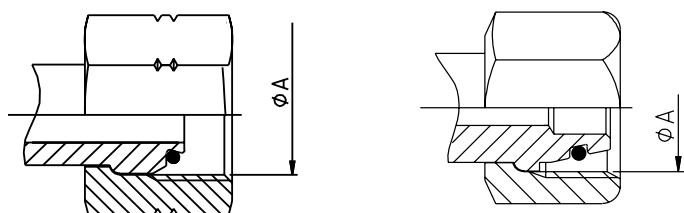

Determinación del tipo de rosca

En general, el aspecto de las roscas de diversos terminales parece igual y dificulta su identificación. Para asegurar una identificación correcta, las roscas se deben medir y comparar con las tablas que figuran en la siguiente sección.

Galga de roscas

Usando una galga de roscas se puede determinar el número de roscas por pulgada. Sujutando la galga y las roscas del acoplamiento delante de un fondo iluminado se puede obtener una medición exacta.

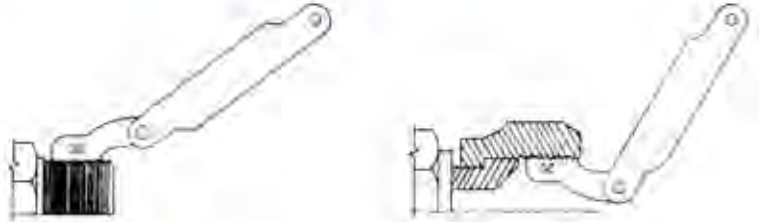

Medida con un calibre

Se debe usar un calibre para medir el diámetro de rosca del punto más grande. (Diámetro exterior (D.E.) de roscas macho – diámetro interior (D.I.) de roscas hembra.)

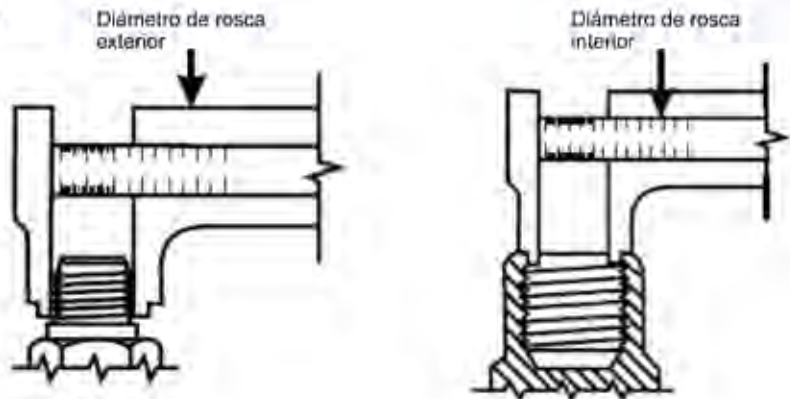

Terminales de manguera DIN alemanes (DIN – Deutsche Industrie Norm)

Conocidos a veces como terminales métricos, estos terminales sellan usando las superficies de estanqueidad anguladas (metal con metal) o la combinación de metal con metal con juntas tóricas. Están disponibles en Serie extra ligera (LL), Serie ligera (L) o Serie pesada (S). Los ángulos de la cara de estanqueidad son o bien 24° con o sin juntas tóricas, o conos universales 24°/60°. La identificación se realiza midiendo el tamaño de rosca y también el diámetro exterior del tubo.

Definido por el diámetro exterior y el paso (distancia entre 2 crestas de la rosca)
ejemplo: M22x1.5 - paso de 1,5 mm

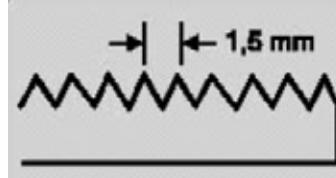

DIN Serie muy ligera (LL)

El cono macho 60° casará sólo con el cono hembra 60°. El macho tiene un ángulo de estanqueidad de 60° (asiento) y rosca métrica cilíndrica. La hembra tiene un asiento de 60° y rosca métrica cilíndrica.

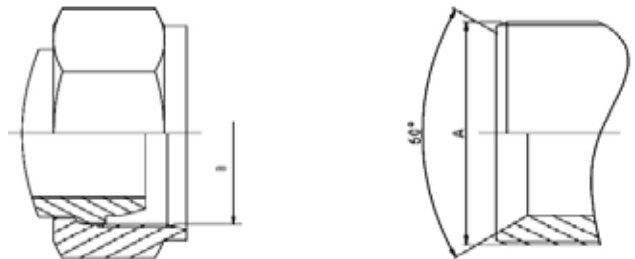

Norma
DIN 20078 Parte 3¹⁾

D.E. Tubo	Rosca métrica	ØA (mm)	ØB (mm)
20	M30x1.5	30,00	28,50
25	M38x1.5	38,00	36,50
32	M45x1.5	45,00	43,50
40	M52x1.5	52,00	50,50
50	M65x2	65,00	63,00

DIN Serie ligera (L) y Serie pesada (S) sin junta tórica

El cono macho de 60° sólo casará con el cono hembra universal de 24° o 60°. El macho tiene un ángulo de estanqueidad de 60° (asiento) y roscas métricas cilíndricas. La hembra tiene un asiento universal de 24° y 60° y roscas métricas cilíndricas.

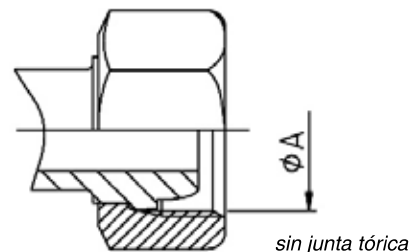

Norma
DIN 20078 Parte 2¹⁾
(antes conocida como **DIN 20078 A, D y E**)

¹⁾ norma obsoleta, sin sustitución exacta

DIN 24° Serie ligera (L) y Serie pesada (S) con junta tórica

El macho tiene un ángulo de estanqueidad de 24° (asiento) y roscas métricas cilíndricas. La hembra tiene un cono convexo de 24° con junta tórica y una tuerca loca métrica.

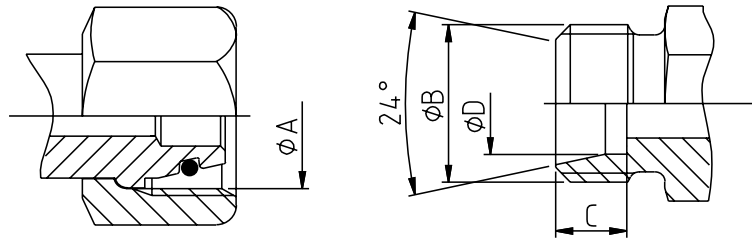

con junta tórica

Norma

ISO 12151-2 / ISO 8434-1 y ISO 8434-4
(Anteriormente DIN 20 078 Parte 4, 5, 8, 9)

Configuraciones de terminales Parker,
Serie ligera:

CA, CE, CF, D0

Configuraciones de terminales Parker,
Serie pesada:

C9, 0C, 1C, D2

D.E. Tubo	Especif.	Rosca métrica	ØA (mm)	ØB (mm)	C (mm)	ØD (mm)
6,00	6L	M12X1.5	10,50	12,00	7,00	6,20
6,00	6S	M14X1.5	12,50	14,00	7,00	6,20
8,00	8L	M14x1.5	12,50	14,00	7,00	8,20
8,00	8S	M16x1.5	14,50	16,00	7,00	8,20
10,00	10L	M16x1.5	14,50	16,00	7,00	10,20
10,00	10S	M18x1.5	16,50	18,00	7,50	10,20
12,00	12L	M18x1.5	16,50	18,00	7,00	12,20
12,00	12S	M20x1.5	18,50	20,00	7,50	12,20
14,00	14S	M22x1.5	20,50	22,00	8,00	14,20
15,00	15L	M22x1.5	20,50	22,00	7,00	15,20
16,00	16S	M24x1.5	22,50	24,00	8,50	16,20
18,00	18L	M26x1.5	24,50	26,00	7,50	18,20
20,00	20S	M30x2	27,90	30,00	10,50	20,20
22,00	22L	M30x2	27,90	30,00	7,50	22,20
25,00	25S	M36x2	33,90	36,00	12,00	25,20
28,00	28L	M36x2	33,90	36,00	7,50	28,20
30,00	30S	M42x2	39,90	42,00	13,50	30,20
35,00	35L	M45x2	42,90	45,00	10,50	35,30
38,00	38S	M52x2	49,90	52,00	16,00	38,30
42,00	42L	M52x2	49,90	52,00	11,00	42,30

Rosca cilíndrica británica (BSP)

También conocida como rosca Whitworth, los terminales con rosca BSP sellan usando superficies anguladas de metal con metal o una combinación de metal con metal y una junta tórica. El ángulo de las superficies de estanqueidad es de 60° para ambas formas. Hay dos formas de rosca populares, rosca cilíndrica británica (BSPP) y rosca cónica británica (BSPT).

La identificación se realiza midiendo el diámetro exterior de la rosca y el número de roscas por pulgada (25,4 mm)

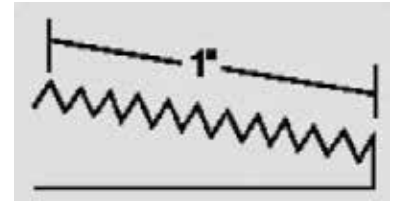

BSPP

Metal con metal sin junta tórica

Norma
BS5200

Configuraciones
de terminales Parker
92, B1, B2, B4, D9

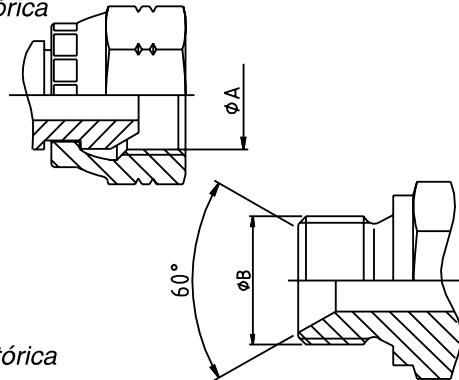

D.E. tubo	tamaño	BSP rosca	ØA (mm)	ØB (mm)
6/10	-2	1/8-28	8,60	9,70
8/13	-4	1/4-19	11,50	13,20
12/17	-6	3/8-19	14,90	16,70
15/21	-8	1/2-14	18,60	20,90
18/23	-10	5/8-14	20,60	22,90
20/27	-12	3/4-14	24,10	26,40
26/34	-16	1"-11	30,30	33,20
33/42	-20	1.1/4-11	38,90	41,90
40/49	-24	1.1/2-11	44,90	47,80
50/60	-32	2-11	56,70	59,60

BSPP

Metal con metal con junta tórica

Norma
ISO 12151-6²⁾

Configuraciones
de terminales Parker
EA, EB, EC, EE, D9

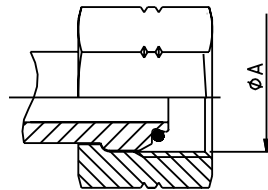

BSPT

Los terminales sellan mediante la interferencia de las roscas. Se debe tener cuidado para no confundir el terminal BSPT con el racor macho NPTF.

BSPT tiene un ángulo de rosca de 55°. NPTF tiene un ángulo de rosca de 60°.

Configuración
de terminales Parker
91

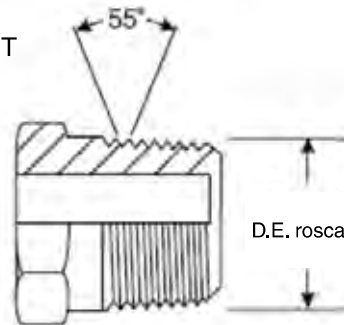

D.E. tubo	tamaño	BSP rosca	ØA (mm)
5/10	-2	1/8-28	9,73
8/13	-4	1/4-19	13,16
12/17	-6	3/8-19	16,66
15/21	-8	1/2-14	20,96
20/27	-12	3/4-14	26,44
26/34	-16	1"-11	33,25
33/42	-20	1.1/4-11	41,91
40/49	-24	1.1/2-11	47,80
50/60	-32	2-11	59,61

BSP Junta plana

Estos terminales tienen roscas cilíndricas BSP, pero la superficie de estanqueidad es plana. La unión se hace cuando la junta compuesta se comprime contra la cara plana hembra.

Configuraciones
de terminales Parker
B5, B6, B7

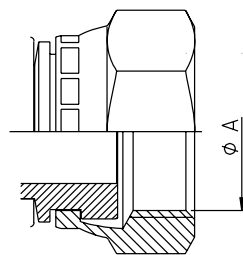

D.E. tubo	tamaño	BSP rosca	ØA (mm)
6/10	-2	1/8-28	8,6
8/13	-4	1/4-19	11,5
12/17	-6	3/8-19	14,9
15/21	-8	1/2-14	18,6
18/23	-10	5/8-14	20,6
20/27	-12	3/4-14	24,1
26/34	-16	1"-11	30,3

²⁾ norma en preparación

Terminales métrica francesa cono 24° Gaz

Típicos del mercado francés, los terminales Gaz franceses tienen un asiento de superficie de estanqueidad de 24° con roscas métricas cilíndricas.

Aunque similares a los terminales DIN alemanes, las roscas difieren en algunos tamaños, ya que los terminales Gaz franceses tienen roscas finas en todos los tamaños mientras que los terminales DIN alemanes utilizan las roscas estándar en los tamaños grandes.

El mecanismo de estanqueidad es de metal con metal.

Los terminales no se especifican en ninguna norma internacional.

Configuraciones de terminales Parker

F6, F9 (tubo métrico)

FG, F2, F4 (tubo Gaz)

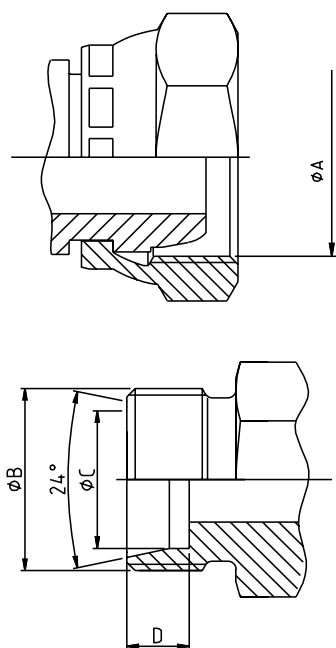

D.E. tubo	Especif.	Rosca métrica	ØA (mm)	ØB (mm)	ØC (mm)	D (mm)
6,00	6N	M12x1	11,00	12,00	6,20	9,00
8,00	8N	M14x1.5	12,50	14,00	8,15	9,00
10,00	10N	M16x1.5	14,50	16,00	10,20	9,00
12,00	12N	M18x1.5	16,50	18,00	12,15	9,00
13,25	13G	M20x1.5	18,50	20,00	13,50	9,00
14,00	14N	M20x1.5	18,50	20,00	14,15	9,00
15,00	15N	M22x1.5	20,50	22,00	15,15	9,00
16,00	16N	M24x1.5	22,50	24,00	16,15	9,00
16,75	17G	M24x1.5	22,50	24,00	17,00	9,00
18,00	18N	M27x1.5	25,50	27,00	18,15	9,00
20,00	20N	M27x1.5	25,50	27,00	20,15	9,00
21,25	21G	M30x1.5	28,50	30,00	21,50	9,00
22,00	22N	M30x1.5	28,50	30,00	22,15	9,00
25,00	25N	M33x1.5	31,50	33,00	25,15	9,00
26,75	27G	M36x1.5	34,50	36,00	27,00	9,00
28,00	28N	M36x1.5	34,50	36,00	28,25	9,00
30,00	30N	M39x1.5	37,50	39,00	30,25	9,00
32,00	32N	M42x1.5	40,50	42,00	32,25	9,00
33,25	34G	M45x1.5	43,50	45,00	33,80	9,00
35,00	35N	M45x1.5	43,50	45,00	35,25	9,00
38,00	38N	M48x1.5	46,50	48,00	38,25	9,00
40,00	40N	M52x1.5	50,50	52,00	40,35	9,00
42,25	42G	M52x1.5	50,50	52,00	42,55	9,00
48,25	49G	M58x2	55,90	58,00	49,00	11,00

Roscas cónicas estancas según normas americanas (NPTF)

Este tipo de terminal utiliza la interferencia entre roscas para sellar y, como tal, tiene una rosca cónica que se deforma y crea la unión. Tienen superficies de estanqueidad de 30°, formando un asiento de 60° invertido (cóncavo). Estos terminales se ven muy frecuentemente en máquinas originarias de los Estados Unidos.

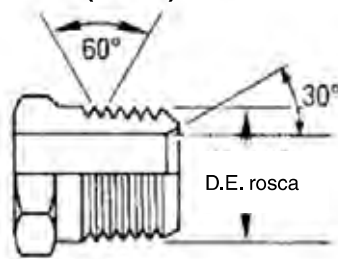

La dimensión ØA se mide en el cuarto paso de la rosca

El macho NPTF casará con las hembras NPTF, NPSF o NPSM.

Se debe tener cuidado para no confundir el terminal NPTF con el racor macho BSPT. Los terminales NPTF tienen un ángulo de rosca de 60°. BSPT tiene un ángulo de rosca de 55°.

Norma
SAE J516

Configuración de terminales Parker
01

tamaño	Rosca NPTF	ØA (mm)	ØB (mm)
-2	1/8-27	10,24	8,73
-4	1/4-18	13,61	11,90
-6	3/8-18	17,05	15,90
-8	1/2-14	21,22	19,05
-12	3/4-14	26,56	24,60
-16	1-11,5	33,22	30,95
-20	1.1/4-11,5	41,98	39,69
-24	1.1/2-11,5	48,05	45,24
-32	2-11,5	60,09	57,15

SAE JIC 37°

Con tipo de estanqueidad de metal con metal y normalmente conocidos como terminales JIC, tienen un cono hembra de 37° (ángulo de superficie de estanqueidad) y roscas UNF.

La especificación de diseño original de los terminales procede de la Sociedad de Ingenieros de Automoción (SAE) y son los terminales americanos más comunes en Europa.

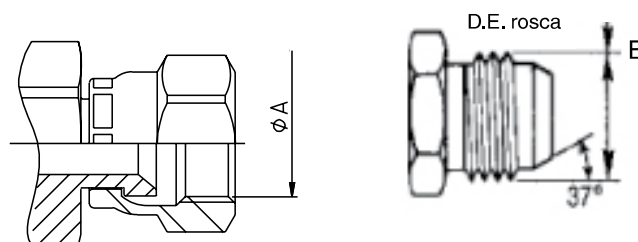

Norma
ISO 12151-5²⁾, ISO8434-2 and SAE J516

Los terminales de manguera Parker JIC son totalmente compatibles con los terminales de tubo y adaptadores Parker Triple-Lok.

Configuraciones de terminales Parker
03, 06/68, 37/3V, 39/3W, 41/3Y, L9

D.E. tubo	Tubo D (mm)	Rosca UNF	tamaño	ØA (mm)	ØB (mm)
3/16"		3/8-24	-3	8,60	9,50
1/4"	6	7/16-20	-4	10,00	11,10
5/16"	8	1/2-20	-5	11,60	12,70
3/8"	10	9/16-18	-6	13,00	14,30
1/2"	12	3/4-16	-8	17,60	19,10
5/8"	14-15-16	7/8-14	-10	20,50	22,20
3/4"	18-20	1.1/16-12	-12	24,60	27,00
7/8"	22	1.3/16-12	-14	28,30	30,10
1"	25	1.5/16-12	-16	31,30	33,30
1.1/4"	30-32	1.5/8-12	-20	39,20	41,30
1.1/2"	38	1.7/8-12	-24	45,60	47,60
2"		2.1/2-12	-32	61,50	63,50

SAE abocardado 45°

El ángulo del abocardado se usa comúnmente como nombre al referirse a los terminales con estanqueidad de metal con metal. Los terminales hembra tienen un asiento invertido cóncavo de 90°, creado por las superficies de estanqueidad con un ángulo de 45°.

El SAE macho abocardado 45° casará con un SAE hembra abocardado 45° sólo o con asiento doble JIC 37°/SAE45°.

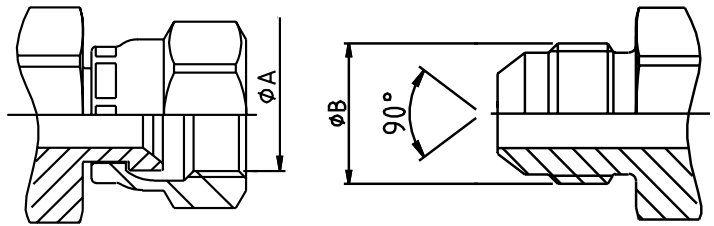

Norma

SAE J516

Configuraciones de terminales Parker

04, 08/68, 77/3V, 79/3W, 81/3Y

D.E. tubo	tamaño	Rosca UNF	ØA (mm)	ØB (mm)
1/4"	-4	7/16-20	9,90	11,10
5/16"	-5	1/2-20	11,50	12,70
3/8"	-6	5/8-18	14,30	15,90
1/2"	-8	3/4-16	17,50	19,10
5/8"	-10	7/8-14	20,60	22,20
3/4"	-12	1.1/16-14	25,00	27,00

SAE con junta tórica (tipo boss)

Este terminal macho tiene roscas cilíndricas, una cara de estanqueidad y una junta tórica. Sólo es compatible con terminales hembra de tipo boss, que se encuentran generalmente en las lumbreras de las máquinas. La estanqueidad se consigue a través de la junta tórica del macho y a través del chaflán de estanqueidad de la hembra.

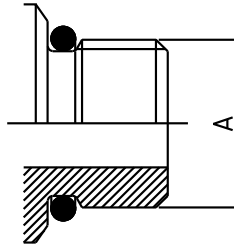

Rosca UNF	tamaño	ØA (mm)
5/16-24	-2	7,93
3/8-24	-3	9,52
7/16-20	-4	11,11
1/2-20	-5	12,70
9/16-18	-6	14,28
3/4-16	-8	19,10
7/8-14	-10	22,22
1.1/16-12	-12	27,00
1.3/16-12	-14	30,10
1.5/16-12	-16	33,30
1.5/8-12	-20	41,30
1.7/8-12	-24	47,60
2.1/2-12	-32	63,50

Configuración de terminales Parker

05

ORFS

Los terminales ORFS se están convirtiendo en el tipo de terminal internacional más utilizado en máquinas de OEM de ámbito mundial debido a su alto nivel de estanqueidad y a su buena resistencia a la vibración. Los terminales utilizan un mecanismo de compresión de junta tórica para sellar. Los terminales hembra tienen caras planas y tuercas locas con rosca cilíndrica UNF. Los terminales macho tienen una junta tórica en una ranura de la cara plana.

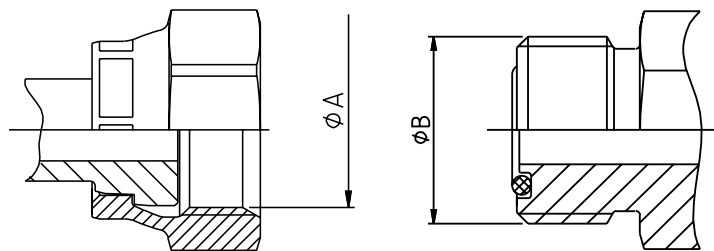

Considerados muy ventajosos, estos terminales ofrecen la posibilidad de construir latiguillos en distancias/espacios fijos, sin tener que mover otros componentes del sistema, debido a la cara plana de los terminales macho y hembra – el latiguillo se puede montar deslizándolo.

Norma

ISO 12151-1, ISO8434-3 y SAE J516

Configuraciones de terminales Parker

JC, JM/J0, JS, JU, J1, J3, J5, J7, J9

D.E. tubo	Tubo D (mm)	Rosca UNF	tamaño	ØA (mm)	ØB (mm)
1/4"	6	9/16-18	-4	13,00	14,20
3/8"	10	11/16-16	-6	15,90	17,50
1/2"	12	13/16-16	-8	19,10	20,60
5/8"	16	1-14	-10	23,80	25,40
3/4"	20	1.3/16-12	-12	28,20	30,10
1"	25	1.7/16-12	-16	34,15	36,50
1.1/4"	32	1.11/16-12	-20	40,50	42,90
1.1/2"	38	2-12	-24	48,80	50,80

Terminales en brida Código 61 y Código 62

El terminal para semibridas de cuatro taladros (o brida completa) se usa en todo el mundo para conectar mangueras de alta presión a bombas, motores y cilindros, donde los latiguillos están sometidos a grandes cargas de presión. El mecanismo de estanqueidad se realiza mediante compresión de la junta tórica en la cara de la cabeza de la brida contra la superficie de la lumbrera/conexión.

Los terminales en brida se dividen generalmente en dos clases de presión, 3000 psi (SFL) y 6000 psi (SFS).

ISO 12151-3 se refiere a los terminales para bridas con código 61 para 3000 psi y código 62 para 6000 psi.

Además de estas bridas, también se pueden encontrar en el mercado bridas Komatsu y CATERPILLAR específicas para clientes.

Configuraciones de terminales Parker

Código 61 (3000 psi)

15, 16, 17, 19, P5, P7, P9

5000 psi (dimensiones código 61)

4A, 4F, 4N

Código 62 (6000 psi)

6A, 6F, 6N, PA, PF, PN, 89

Brida Caterpillar

XA, XF, XG, XN

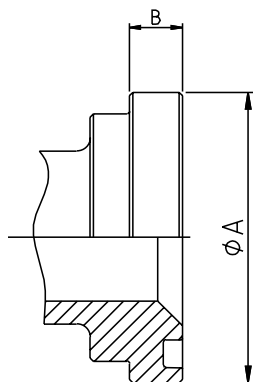

- Código estándar 61 para 3000 a 5000 psi máx., dependiendo del tamaño
- Código de alta presión 62 para 6000 psi máx., con independencia del tamaño

Brida (pulg)	tam.	código 61	código 62
1/2	-8	34,5 / 5000	41,3/ 6000
3/4	-12	34,5/ 5000	41,3/ 6000
1	-16	34,5/ 5000	41,3/ 6000
1.1/4	-20	27,5/ 4000	41,3/ 6000
1.1/2	-24	20,7/ 3000	41,3/ 6000
2	-32	20,7/3000	41,3/ 6000

Código 61 - SAE 3000PSI

Brida (pulg)	tam.	ØA (mm)	B (mm)	Junta tórica
1/2"	-8	30,18	6,73	18,64x3,53
3/4"	-12	38,10	6,73	24,99x3,53
1"	-16	44,45	8,00	32,92x3,53
1.1/4"	-20	50,80	8,00	37,69x3,53
1.1/2"	-24	60,33	8,00	47,22x3,53
2"	-32	71,42	9,53	56,74x3,53
2.1/2"	-40	84,12	9,53	69,44x3,53
3"	-48	101,60	9,53	85,32x3,53

Código 62 - SAE 6000 PSI

Brida (pulg)	tam.	ØA (mm)	B (mm)	Junta tórica
1/2"	-8	31,75	7,75	18,64x3,53
3/4"	-12	41,28	8,76	24,99x3,53
1"	-16	47,63	9,53	32,92x3,53
1.1/4"	-20	53,98	10,29	37,69x3,53
1.1/2"	-24	63,50	12,57	47,22x3,53
2"	-32	79,38	12,57	56,74x3,53

CATERPILLAR®

Brida (pulg)	tam.	ØA (mm)	B (mm)	D-Ring
3/4"	-12	41,28	14,22	25,40x5,00
1"	-16	47,63	14,22	31,90x5,00
1.1/4"	-20	53,98	14,22	38,20x5,00
1.1/2"	-24	63,50	14,22	44,70x5,00

Aunque no está incluida en las normas SAE ni ISO, la cabeza de brida de tamaño -10 (5/8) está ganando popularidad.

Esta brida se encuentra a menudo en equipos Komatsu y en accionamientos hidrostáticos de maquinaria agrícola.

Brida (pulg)	tam.	ØA (mm)	B (mm)	Junta tórica
5/8"	-10	34,25	6,00	21,7x3,5

Semibrida de cuatro taladros

Las semibridas de cuatro taladros se usan para fijar los terminales en brida a sus lumbreras.

- Código estándar 61 para 3000 a 5000 psi máx., dependiendo del tamaño
- Código de alta presión 62 para 6000 psi máx., con independencia del tamaño

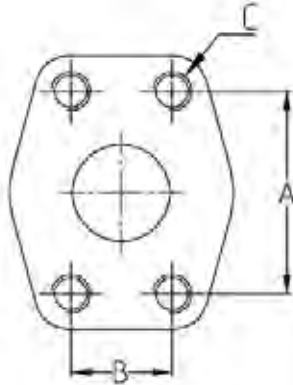

dimensiones de lumbrera

Código 61 - SAE 3000 psi

Brida	tam.	A (mm)	B (mm)	C	
				(pulg)	(métr.)
1/2"	-8	38.1	17.5	5/16-18	M8x1,25
3/4"	-12	47.6	22.3	3/8-16	M10x1,5
1"	-16	52.4	26.2	3/8-16	M10x1,5
1-1/4"	-20	58.7	30.2	7/16-14	M10x1,5
1-1/2"	-24	69.9	35.7	1/2-13	M12x1,75
2"	-32	77.8	42.8	1/2-13	M12x1,75*

Código 62 - SAE 6000 psi

Brida	tam.	A (mm)	B (mm)	C	
				(pulg)	(métr.)
1/2"	-8	40.5	18.2	5/16-18	M8x1,25
3/4"	-12	50.8	23.8	3/8-16	M10x1,5
1"	-16	57.2	27.8	7/16-14	M12x1,75
1-1/4"	-20	66.7	31.8	1/2-13	M12x1,75*
1-1/2"	-24	79.4	36.5	5/8-11	M16x2
2"	-32	96.8	44.4	3/4-10	M20x2,5

* M14x2 todavía se usa en el mercado, pero ya no es conforme a ISO6162.

Terminales japoneses – JIS

Las normas industriales japonesas (JIS) se emplean en la mayoría de los equipos japoneses y usan un ángulo de estanqueidad de 30° y rosca cilíndrica británica o rosca métrica. Se debe tener cuidado para no confundir los terminales JIS con los terminales BSP o JIC.

El mecanismo de estanqueidad de los terminales es el de superficies anguladas 30° de metal con metal.

Configuraciones de terminales Parker
MU, XU (Metric)
FU (BSP)

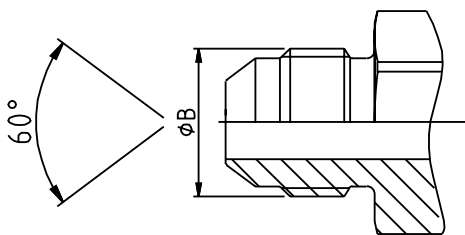
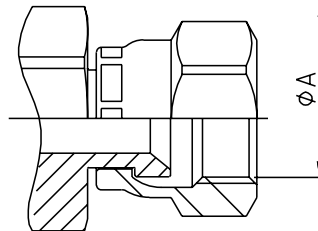

JIS 30° métrica

	Símbolo	Rosca métrica	ØA (mm)	ØB (mm)
	MU-6	M14x1.5	12,50	14,00
	MU-9	M18x1.5	16,50	18,00
	MU-12	M22x1.5	20,50	22,00
	MU-15	M27x2	25,00	27,00
	MU-19	M27x2	25,00	27,00
	MU-25	M33x2	31,00	33,00
	MU-32	M42x2	40,00	42,00
	MU-38	M50x2	48,00	50,00
	MU-50	M60x2	58,00	60,00

JIS 30° BSP

	Símbolo	Rosca BSP	ØA (mm)	ØB (mm)
	GUI-3	1/8-28	8,60	9,70
	GUI-5/6	1/4-19	11,50	13,20
	GUI-8/9	3/8-19	14,90	16,70
	GUI-12	1/2-14	18,60	20,90
	GUI-15/19	3/4-14	24,10	26,40
	GUI-25	1"-11	30,30	33,20
	GUI-32	1.1/4-11	38,90	41,90
	GUI-38	1.1/2-11	44,90	47,80
	GUI-50	2-11	56,70	59,60

MANGUERAS



BCH1

No-Skive

EN 857 1SC – ISO 11237



- Construcción de manguera *No-Skive*
- Alto rendimiento
- Tubo interior de NBR – compatibilidad con fluidos extendida
- Cumple con la presión de trabajo y el radio de curvatura especificados por la EN 857 1SCSC
- Compuesto de cubierta de caucho sintético
- Radio de curvatura reducido

Aplicaciones primarias

Aplicaciones exigentes hidráulicas de presión media en todos los mercados

Construcción de manguera

Tubo interior: Nitrilo (NBR)
Refuerzo: Malla de alambre de acero de alta resistencia
Cubierta: Goma sintética

Fluidos Recomendados

Fluidos con base de petróleo y agua-glicol, aceites lubricantes, aire y agua. Para aire por encima de 1,7 MPa hay que picar la cubierta de la manguera.

Rango de temperatura -40 °C hasta +100 °C

Excepción: Aire máx. +70 °C
Agua máx. +85 °C

Terminales serie



Referencia	Manguera D.I.				Manguera D.E. mm	Calificación de Presión				radio de doblado mínimo mm	peso kg
	DN	Pulg.	Tamaño	mm		presión de trabajo máx. MPa	psi	presión de estallido min. MPa	psi		
BCH1-4	6	1/4	-4	6,4	11,5	22,5	3260	90,0	13050	75	0,17
BCH1-5	8	5/16	-5	7,9	13,6	21,5	3110	86,0	12470	85	0,20
BCH1-6	10	3/8	-6	9,5	15,5	18,0	2610	72,0	10440	90	0,24
BCH1-8	12	1/2	-8	12,7	18,9	16,0	2320	64,0	9280	130	0,33
BCH1-10	16	5/8	-10	15,9	22,2	13,0	1885	52,0	7540	150	0,41
BCH1-12	20	3/4	-12	19,1	26,0	10,5	1520	42,0	6080	180	0,56
BCH1-16	25	1	-16	25,4	33,3	8,8	1275	35,2	5100	230	0,75

La combinación de alta temperatura y presión podrían reducir la vida útil de la manguera.

Ejemplo de layline de manguera

Parker NO-SKIVE BCH1-6 WP 18.0 MPa (2610 PSI) I •• 10 mm (3/8) EN857/1SC/10 MADE IN ITALY

BCH2

No-Skive

EN 857 2SC – ISO 11237



- Construcción de manguera *No-Skive*
- Alto rendimiento
- Tubo interior de NBR – compatibilidad con fluidos extendida
- Cumple con la presión de trabajo y el radio de curvatura especificados por la EN 857 2SC
- Compuesto de cubierta de caucho sintético
- Radio de curvatura reducido

Aplicaciones primarias

Aplicaciones exigentes hidráulicas de presión media en todos los mercados

Construcción de manguera

Tubo interior: Nitrilo (NBR)

Refuerzo: Doble malla de alambre de acero de alta resistencia

Cubierta: Goma sintética

Fluidos Recomendados

Fluidos con base de petróleo y agua-glicol, aceites lubricantes, aire y agua. Para aire por encima de 1,7 MPa hay que picar la cubierta de la manguera.

Rango de temperatura -40 °C hasta +100 °C

Excepción: Aire máx. +70 °C

Agua máx. +85 °C

Terminales serie



Referencia	Manguera D.I.				Manguera D.E. mm	Calificación de Presión				radio de doblado mínimo mm	peso kg
	DN	Pulg.	Tamaño	mm		presión de trabajo máx. MPa	psi	presión de estallido min. MPa	psi		
BCH2-4	6	1/4	-4	6,4	13,4	40,0	5800	160,0	23200	75	0,28
BCH2-5	8	5/16	-5	7,9	15,0	35,0	5000	140,0	20000	85	0,31
BCH2-6	10	3/8	-6	9,5	17,2	33,0	4800	132,0	19200	90	0,39
BCH2-8	12	1/2	-8	12,7	20,4	27,5	4000	110,0	16000	130	0,50
BCH2-10	16	5/8	-10	15,9	23,9	25,0	3600	100,0	14400	170	0,63
BCH2-12	20	3/4	-12	19,1	27,7	21,5	3100	86,0	12400	200	0,81
BCH2-16	25	1	-16	25,4	35,4	16,5	2400	66,0	9600	250	1,06

La combinación de alta temperatura y presión podrían reducir la vida útil de la manguera.

Ejemplo de layline de manguera

NO-SKIVE BCH2-6 WP 33 MPa (4800 PSI) I •• 10 mm (3/8) EN857/2SC/10 MADE IN ITALY

SX35

No-Skive Multispiral

ISO 3862 Tipo R13 – Especificaciones Parker



- Construcción de manguera *No-Skive*
- Alto rendimiento
- Refuerzo de cuatro alambres de acero de alta tracción
- Presión constante 35,0 MPa
- Rango de temperatura hasta +125 °C

Aplicaciones primarias

Aplicaciones hidráulicas de alta presión general

Especificaciones aplicables

ISO 3862 Tipo R13 – Especificación Parker

Construcción de manguera

Tubo interior: Goma sintética

Refuerzo: 4 mallas de alambre de acero de alta resistencia

Cubierta: Goma sintética

Fluidos recomendados

Fluidos con base de petróleo y agua-glicol, aceites lubricantes, aire y agua. Para aire por encima de 1,7 MPa hay que picar la cubierta de la manguera.

Rango de temperatura -40 °C hasta +125 °C

Excepción: Aire máx. +70 °C

Agua máx. +85 °C

Terminales serie

SX35-3WB-12

SX35-12, SX35-16 y SX35-20



Referencia	Manguera D.I.				Manguera D.E. mm	Calificación de Presión				radio de doblado mínimo mm	peso kg
	DN	Pulg.	Tamaño	mm		presión de trabajo máx. MPa	psi	presión de estallido min. MPa	psi		
* SX35-3WB-12	20	3/4	-12	19,1	32,2	35,0	5000	140,0	20000	260	1,36
SX35-12	20	3/4	-12	19,1	32,4	35,0	5000	140,0	20000	240	1,72
SX35-16	25	1	-16	25,4	38,2	35,0	5000	140,0	20000	300	2,14
SX35-20	32	1 1/4	-20	31,5	46,3	35,0	5000	140,0	20000	420	2,96

La combinación de alta temperatura y presión podrían reducir la vida útil de la manguera.

Ejemplo de layline de manguera

Parker NO-SKIVE - SX35-12 WP 35,0 MPa (5000 PSI) I° ISO 3862 4SP / R13 - 19 mm (3/4") MADE IN ITALY

SX42

No-Skive Multispiral

ISO 3862 Tipo R15 – Especificaciones Parker



- Construcción de manguera *No-Skive*
- Alto rendimiento
- Refuerzo de cuatro o seis alambres de acero de alta tracción
- Presión constante 42,0 MPa
- Rango de temperatura hasta +125 °C

Aplicaciones primarias

Aplicaciones hidráulicas de alta presión general

Especificaciones aplicables

ISO 3862 Tipo R15 – Especificación Parker

Construcción de manguera

Tubo interior: Goma sintética
Refuerzo: 4 ó 6 espirales de alambre de acero de alta resistencia
Cubierta: Goma sintética

Rango de temperatura -40 °C hasta +125 °C

Excepción: Aire máx. +70 °C
Agua máx. +85 °C

Fluidos Recomendados

Fluidos con base de petróleo y agua-glicol, aceites lubricantes, aire y agua. Para aire por encima de 1,7 MPa hay que picar la cubierta de la manguera.

Terminales serie

Size -12

Size -16 y -20



Referencia	Manguera D.I.				Manguera D.E. mm	Calificación de Presión				radio de doblado mínimo mm	peso kg
	DN	Pulg.	Tamaño	mm		presión de trabajo máx. MPa	psi	presión de estallido min. MPa	psi		
SX42-12	20	3/4	-12	19,1	32,4	42,0	6000	168,0	24000	260	1,72
SX42-16	25	1	-16	25,4	38,2	42,0	6000	168,0	24000	330	1,74
SX42-20	32	1 1/4	-20	31,5	46,3	42,0	6000	168,0	24000	400	2,98

La combinación de alta temperatura y presión podrían reducir la vida útil de la manguera.

Ejemplo de layline de manguera

Parker NO-SKIVE - SX42-12 WP 42,0 MPa (6000 PSI) I° ISO 3862 R15 - 19 mm (3/4") MADE IN ITALY

221FR

No-Skive Retardante al fuego
para combustible y motor marino

Aplicaciones primarias

Marina: Manguera para combustible marino
General: Cuando la protección contra fuego es importante

Especificaciones aplicables

SAE J1527 R3, USCG Tipo AI, SAE J1942, ISO 7840

Construcción de manguera

Tubo interior: Goma resistente a combustible y aceite
Refuerzo: Malla de alambre de acero de alta resistencia
Cubierta: Cubierta de PKR azul retardante de fuego

Rango de temperatura -20 °C hasta +100 °C

Excepción: Aire máx. +70 °C
Agua máx. +85 °C



- Cubierta resistente al fuego
- Construcción de manguera *No-Skive*
- Aprobación marina

Fluidos recomendados

Petroleum based hydraulic fluids, water-glycol and water-oil emulsion hydraulic fluids, grease, lubricants, crude, fuel oils and water.

Terminales serie



Referencia	Manguera D.I.			Manguera D.E. mm	Índices de presión				Vacío kilo Pascal *1 kPa	min. bend radius mm	Peso kg
	Pulg.	Tamaño	mm		max. working pressure MPa	psi	min. burst pressure MPa	psi			
221FR-5	1/4	-5	6,3	15	3,5	500	14,0	2000	81	25	0,28
221FR-6	5/16	-6	8,0	17	3,5	500	14,0	2000	81	30	0,34
221FR-8	13/32	-8	10,0	20	3,5	500	14,0	2000	81	45	0,42
221FR-10	1/2	-10	12,5	23	3,5	500	14,0	2000	68	55	0,58
221FR-12	5/8	-12	16,0	27	3,5	500	14,0	2000	68	70	0,61
221FR-16	7/8	-16	22,0	31	3,5	500	14,0	2000	68	90	0,70

*1 = Los valores de vacío en la tabla son de vacío relativo a presión en kPa. Para valores absolutos, reste el valor en la tabla de 101 kPa.
La combinación de alta temperatura y alta presión puede reducir la vida de la manguera.

Ejemplo de layline de manguera

PARKER 221FR-10 SAE J1527 USCG TYPE A1 CE 1085 ISO 7840-A1 WITH 26 SERIES CRIMP FITTINGS ONLY

285

Aire acondicionado y refrigerante

SAE J2064 Tipo C, Clase 1

Aplicaciones primarias

Aire acondicionado:

Para aplicaciones industriales y móviles

Especificaciones aplicables

SAE J2064 Tipo C, Clase 1

Construcción de manguera

Tubo interior: Una barrera de nylon entre dos capas elastoméricas

Refuerzo: Una malla textil

Cubierta: Heat, moisture and Goma resistentes al calor, humedad y ozono



- Construcción de manguera *No-Skive*
- Para los principales fluidos refrigerantes
- Compatible con refrigerantes modernos

Fluidos recomendados

Para uso con refrigerantes Freon 12, 134a y 22.

Rango de temperatura -30 °C hasta +125 °C

Terminales serie



Referencia	Manguera D.I.			Manguera D.E.	Índices de presión				Vacío kilo Pascal *1	min. bend radius	Peso
	Pulg.	Tamaño	mm		max. working pressure	min. burst pressure					
						MPa	psi	MPa			
285-4-RL	3/16	-4	5,0	12,4	3,4	500	17,2	2500	95	25	0,14
285-6-RL	5/16	-6	8,0	15,7	3,4	500	17,2	2500	95	38	0,19
285-8-RL	13/32	-8	10,0	18,8	3,4	500	17,2	2500	95	51	0,25
285-10-RL	1/2	-10	12,5	21,1	3,4	500	17,2	2500	95	64	0,27
285-12-RL	5/8	-12	16,0	24,4	3,4	500	17,2	2500	95	76	0,34

*1 = los valores de vacío en la tabla son de vacío relativo a presión en kPa. Para valores absolutos, reste el valor en la tabla de 101 kPa.

Para tamaños -16 hay una manguera 235-16 disponible a petición

RL = sólo disponible en carretes

Ejemplo de layline de manguera

PARKER 285-10 WP 3,4 MPa (500 PSI) SAE J2064 TYPE C CLASS I 12,5 mm (1/2) 10-4Q09

372

Compacta *No-Skive*

3 mallas de alambre para presiones de trabajo de 4SP

Aplicaciones primarias

Aplicaciones hidráulicas generales de alta presión y bajo radio de curvatura

Especificaciones aplicables

Especificación Parker

Construcción de manguera

- Tubo interior: Nitrilo (NBR)
- Refuerzo: Malla triple de alambre de acero de alta resistencia
- Cubierta: Goma sintética

Rango de temperatura -40 °C hasta +100 °C

- Excepción: Aire máx. +70 °C
- Agua máx. +85 °C



- Construcción de manguera *No-Skive*
 - diseño compacto
- Tubo interno de nitrilo (NBR)
 - alta resistencia química

Fluidos recomendados

Fluidos con base de petróleo y agua-glicol, aceites lubricantes, aire y agua. Para aire por encima de 1,7 MPa hay que picar la cubierta de la manguera.

Terminales serie



Referencia	Manguera D.I.				Manguera D.E.		Calificación de Presión				radio de doblado mínimo	peso
	DN	Pulg.	Tamaño	mm	mm	presión de trabajo máx.	presión de estallido min.	mm	kg			
						MPa	psi	MPa	psi			
372-6	10	3/8	-6	9,5	21,4	44,5	6500	178,0	25800	120	0,73	
372-8	12	1/2	-8	12,7	24,6	41,5	6000	166,0	24000	160	0,90	
372-10	16	5/8	-10	15,9	28,2	35,0	5000	140,0	20000	210	1,09	
372-12	19	3/4	-12	19,1	32,2	35,0	5000	140,0	20000	260	1,36	
372-16	25	1	-16	25,4	39,7	28,0	4000	112,0	16000	310	1,78	

La combinación de alta temperatura y presión podrían reducir la vida útil de la manguera.

Ejemplo de layline de manguera

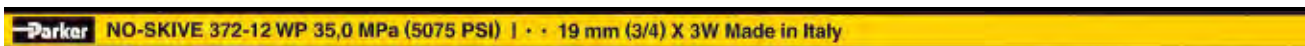

462

Compacta Elite

DIN EN 857 2SC – ISO 11237 Tipo 2SC

Aplicaciones primarias

Aplicaciones hidráulicas de media presión y altas demandas para todos los mercados

Especificaciones aplicables

Excede EN 857-2SC – ISO 11237 Tipo 2SC

Construcción de manguera

- Tubo interior: Nitrilo (NBR)
- Refuerzo: Doble malla de alambre de acero de alta resistencia
- Cubierta: Goma sintética

Rango de temperatura -40 °C hasta +100 °C

- Excepción: Aire máx. +70 °C
- Agua máx. +85 °C



- Construcción de manguera *No-Skive* – diseño compacto
- Tubo interno de nitrilo (NBR) – alta resistencia química
- Excede especificaciones EN/ISO para presión, radio de curvatura y resistencia a abrasión

Fluidos recomendados

Fluidos con base de petróleo y agua-glicol, aceites lubricantes, aire y agua. Para aire por encima de 1,7 MPa hay que picar la cubierta de la manguera.

Terminales serie

- para tamaños -4 hasta -16
- para tamaños -20



Referencia	Manguera D.I.				Manguera D.E.		Calificación de Presión				radio de doblado mínimo	peso
	DN	Pulg.	Tamaño	mm	mm	presión de trabajo máx.	presión de estallido min.	mm	kg			
						MPa	psi	MPa	psi			
462-4	6	1/4	-4	6,4	13,4	42,5	6160	170,0	24640	75	0,30	
462-5	8	5/16	-5	7,9	15,0	40,0	5800	160,0	23200	85	0,35	
462-6	10	3/8	-6	9,5	17,2	35,0	5075	140,0	20300	90	0,42	
462-8	12	1/2	-8	12,7	20,4	31,0	4495	124,0	17980	130	0,52	
462-10	16	5/8	-10	15,9	23,9	28,0	4060	112,0	16240	160	0,66	
462-12	19	3/4	-12	19,1	27,7	28,0	4060	112,0	16240	195	0,86	
462-16	25	1	-16	25,4	35,4	21,0	3045	84,0	12180	250	1,17	
462-20	31	1 1/4	-20	31,8	45,1	17,2	2495	68,8	9980	335	1,80	

Referencia sin sufijo: la manguera tiene apariencia lisa. Referencia con sufijo WR: la cubierta de manguera tiene apariencia de envoltura. La combinación de alta temperatura y alta presión podría reducir la vida útil de la manguera. También disponible en carretes bajo la referencia 462-xx-RL

Ejemplo de layline de manguera



463

Compacta *No-Skive*

Limpieza con agua a muy alta presión



- Construcción de manguera *No-Skive* – diseño compacto
- para agua a temperatura constante hasta 120 °C

Aplicaciones primarias
Limpiaadores de alta presión

Construcción de manguera

Tubo interior: Goma sintética
 Refuerzo: Doble malla de alambre de acero de alta resistencia
 Cubierta: Goma sintética , negro o azul

Rango de temperaturaAgua máx. +120 °C

Terminales serie



Referencia	Manguera D.I.				Manguera D.E.	Calificación de Presión				radio de doblado mínimo	peso
	DN	Pulg.	Tamaño	mm		presión de trabajo máx.		presión de estallido min.			
						MPa	psi	MPa	psi		
463-5	8	5/16	-5	7,9	15,0	40	5800	120,0	17400	75	0,31
463-5-BLU	8	5/16	-5	7,9	15,0	40	5800	120,0	17400	75	0,31
463-6	10	3/8	-6	9,5	17,4	40	5800	120,0	17400	90	0,38
463-6-BLU	10	3/8	-6	9,5	17,4	40	5800	120,0	17400	90	0,38
463-8	12	1/2	-8	12,7	20,6	35	5075	105,0	15225	110	0,48
463-8-BLU	12	1/2	-8	12,7	20,6	35	5075	105,0	15225	110	0,48

Protector de goma Referencia WKS-X-XXX en negro o azul, por favor vea página Eb-20.
 La combinación de alta temperatura y alta presión podría reducir la vida útil de la manguera.
 También disponible en carretes bajo referencia 463-xx-RL

Ejemplo de layline de manguera



493

Compacta *No-Skive*

Limpieza con agua a muy alta presión



- Construcción de manguera *No-Skive* – diseño compacto
- para agua a temperatura constante hasta 120 °C

Aplicaciones primarias

Limpiadores de alta presión

Construcción de manguera

- Tubo interior: Goma sintética
 Refuerzo: Malla de alambre de acero de alta resistencia
 Cubierta: Goma sintética , negro o azul

Rango de temperaturaAgua máx. +120 °C

Terminales serie



Referencia	Manguera D.I.				Manguera D.E. mm	Calificación de Presión				radio de doblado mínimo mm	peso kg
	DN	Pulg.	Tamaño	mm		presión de trabajo máx. MPa	psi	presión de estallido min. MPa	psi		
493-4	6	1/4	-4	6,4	13,4	20,0	2898	60,0	8695	60	0,18
493-4-BLU	6	1/4	-4	6,4	13,4	20,0	2898	60,0	8695	60	0,18
493-5	8	5/16	-5	7,9	15,0	20,0	2898	60,0	8695	75	0,21
493-5-BLU	8	5/16	-5	7,9	15,0	20,0	2898	60,0	8695	75	0,21
493-6	10	3/8	-6	9,5	17,4	20,0	2898	60,0	8695	90	0,25
493-6-BLU	10	3/8	-6	9,5	17,4	20,0	2898	60,0	8695	90	0,25
493-8	12	1/2	-8	12,7	20,6	17,5	2536	52,5	7608	110	0,33
493-8-BLU	12	1/2	-8	12,7	20,6	17,5	2536	52,5	7608	110	0,33

Protector de goma Referencia WKS-X-XXX en negro o azul, por favor vea página Eb-20.
 La combinación de alta temperatura y alta presión podría reducir la vida útil de la manguera.
 También disponible en carretes bajo referencia 493-xx-RL

Ejemplo de layline de manguera

PARKER NO-SKIVE 493-5 WP 20,0 MPa [2898 PSI] 1" x 8 mm [5/16] max. 120°C WATER

731

No-Skive Multiespiral

ISO 3862 Tipo 4SH – DIN EN 856 Tipo 4SH



- Construcción de manguera *No-Skive*
- Refuerzo de 4 alambres de acero de alta resistencia

Aplicaciones primarias

Aplicaciones hidráulicas de alta presión general

Especificaciones aplicables

Excede ISO 3862 Tipo 4SH – EN 856 Tipo 4SH

Construcción de manguera

Tubo interior: Goma sintética

Refuerzo: 4 mallas de alambre de acero de alta resistencia

Cubierta: Goma sintética

Fluidos recomendados

Fluidos con base de petróleo y agua-glicol, aceites lubricantes, aire y agua. Para aire por encima de 1,7 MPa hay que picar la cubierta de la manguera.

Rango de temperatura -40 °C hasta +100 °C

Excepción: Aire máx. +70 °C

Agua máx. +85 °C

Terminales serie



Referencia	Manguera D.I.				Manguera D.E.		Calificación de Presión				radio de doblado mínimo	peso
	DN	Pulg.	Tamaño	mm	mm	mm	presión de trabajo máx.	presión de estallido min.	mm	kg		
							MPa	psi	MPa	psi		
731-12	19	3/4	-12	19,1	32,0	42,0	6000	168,0	24000	280	1,72	
731-16	25	1	-16	25,4	39,0	38,0	5500	152,0	22000	340	2,14	
731-20	31	1 1/4	-20	31,8	45,0	32,0	4700	130,0	18800	460	2,96	
731-24	38	1 1/2	-24	38,1	53,0	29,0	4200	116,0	16800	560	3,20	
731-32	51	2	-32	50,8	68,0	25,0	3600	100,0	14400	700	5,30	

La combinación de alta temperatura y presión podrían reducir la vida útil de la manguera.

Ejemplo de layline de manguera

Parker NO-SKIVE 731-12 WP 42,0 MPa (6000 PSI) MSHA XXXX 19 mm (3/4) X 4S EN 856-4SH/20/4Q91

787TC

No-Skive GlobalCore Compact Spiral™

Tamaños -4 hasta -6 excede ISO 18752-AC
Tamaños -8 hasta -32 excede ISO 18752-DC

Aplicaciones primarias

Instalaciones en tierra y en alta mar, construcción, moldeado por inyección, minería

Especificaciones aplicables

Excede SAE 100R13 – ISO 3862 Tipo R13 – EN 856 Tipo R13 – ISO 18752-AC/DC

Construcción de manguera

Tubo interior: Caucho sintético patentado
Refuerzo: 4 ó 6 espirales de alambre de acero de alta resistencia
Cubierta: Goma sintética aceptada MSHA

Rango de temperatura -40 °C hasta +125 °C

Excepción: Aire máx. +70 °C
Agua máx. +85 °C



- 1/2 del radio de curvatura de SAE 100R13
- Presión constante de 35,0 MPa
- D.E. reducido y construcción nueva que proporcionan una flexibilidad superior
- 1/3 menos de esfuerzo al doblado
- Reducción del peso: hasta 26 %
- Resistente a alta abrasión **TOUGH COVER**
- Aprobación MSHA
- La manguera está indicada para inmersión temporal en aceite mineral hasta 70 °C con inspecciones frecuentes

Fluidos recomendados

Fluidos hidráulicos derivados del petróleo y aceites lubricantes. Amplia compatibilidad que supera la Columna III, con resistencia química adicional, especialmente para diésel y biodiesel.

Terminales serie

Series 43/48 para tamaños -4 y -6



Series 77 para tamaños -8 hasta -32

Referencia	Manguera D.I.				Manguera D.E.		Calificación de Presión				radio de doblado mínimo	peso
	DN	Pulg.	Tamaño	mm	mm	presión de trabajo máx.	presión de estallido min.	mm	kg			
						MPa	psi	MPa	psi			
787TC-4	6	1/4	4	6,3	13,0	35,0	5000	140,0	20000	50	0,31	
787TC-6	10	3/8	-6	10,0	17,2	35,0	5000	140,0	20000	63	0,42	
787TC-8	12	1/2	-8	12,7	21,1	35,0	5000	140,0	20000	90	0,67	
787TC-10	16	5/8	-10	15,9	23,9	35,0	5000	140,0	20000	100	0,80	
787TC-12	19	3/4	-12	19,1	27,9	35,0	5000	140,0	20000	120	1,16	
787TC-16	25	1	-16	25,4	35,7	35,0	5000	140,0	20000	150	1,74	
787TC-20	31	1 1/4	-20	31,8	44,9	35,0	5000	140,0	20000	210	2,89	
787TC-24	38	1 1/2	-24	38,1	52,8	35,0	5000	140,0	20000	255	3,96	
787TC-32	51	2	-32	50,8	67,6	35,0	5000	140,0	20000	318	6,50	

Cambie la manguera cuando sea visible cualquier deformación o daño de la cubierta de la manguera. La combinación de alta temperatura y presión podrían reducir la vida útil de la manguera.

Ejemplo de layline de manguera



811

No-Skive Línea de succión y retorno SAE 100R4



- Construcción de manguera *No-Skive*
- Alambre helicoidal para evitar su aplastamiento en vacío
- Radios de curvatura pequeños

Aplicaciones primarias

Todos los mercados: Aplicaciones generales

Construcción de manguera

Tubo interior: Goma sintética
 Refuerzo: Dos espirales de fibra, un alambre helicoidal
 Cubierta: Goma sintética, resistente a aceite y condiciones climáticas

Fluidos recomendados

Fluidos hidráulicos en una base de minerales-aceite, agua-glicol y aceites lubricantes, aire y agua.

Rango de temperatura -40 °C hasta +100 °C

Excepción: Aire máx. +70 °C
 Agua máx. +85 °C

Terminales serie

hasta tamaños - 32
 para tamaños -40 e -48



Part Number	Hose I.D.				Hose O.D. mm	Pressure Rating				Vaccum* kPa	min. bend radius mm	weight kg
	DN	Inch	Size	mm		max. working pressure		min. burst pressure				
						MPa	psi	MPa	psi			
811-12	19	3/4	-12	19,1	30,0	2,1	300	8,3	1200	85	65	0,63
811-16	25	1	-16	25,4	38,0	1,7	250	6,9	1000	85	75	0,96
811-20	31	1 1/4	-20	31,8	45,0	1,4	200	5,5	800	85	100	1,22
811-24	38	1 1/2	-24	38,1	52,0	1,0	150	4,1	600	85	130	1,55
811-32	51	2	-32	50,8	64,0	0,7	100	2,8	400	85	150	1,87
811-40	63	2 1/2	-40	63,5	75,0	0,4	62	1,6	248	85	180	2,45
811-48	76	3	-48	76,2	90,0	0,4	62	1,6	248	85	230	3,20

* Los valores de vacío listados en la tabla son valores de presión en vacío en kPa. Para valor absoluto reste el valor de la tabla de 101 kPa.

** tamaño 12/16: sólo en prensa Parkrimp 2 o prensas ajustables.

La combinación de alta temperatura y presión podrían reducir la vida útil de la manguera.

Ejemplo de layline de manguera

PARKER 811-12 SUCTION HOSE SAE 100R4-12 19 mm (3/4) 3Q81 ————— PARKER 811-12 SUC

881

No-Skive Línea de succión y retorno SAE 100R4



- Construcción de manguera *No-Skive*
- Alambre helicoidal para evitar su aplastamiento en vacío
- Temperatura de trabajo hasta +121 °C
- Aprobación MSHA

Aplicaciones primarias

Todos los mercados:
Para aplicaciones de alta temperatura
Para aplicaciones generales

Construcción de manguera

Tubo interior: Goma sintética
Refuerzo: Doble malla textil combinada con espiral de alambre alrededor del refuerzo textil
Cubierta: Goma sintética aceptada MSHA

Rango de temperatura -40 °C hasta +121 °C

Excepción: Aire máx. +70 °C
Agua máx. +85 °C

Fluidos recomendados

Fluidos hidráulicos en una base de minerales-aceite, agua-glicol y aceites lubricantes, aire y agua.

Terminales serie



Series 43 para tamaños -12, -16
Series 48 para tamaños -20 hasta -32
Para tamaño -40 serie de terminales a petición

Part Number	Hose I.D.				Hose O.D. mm	Pressure Rating				Vacuum* kPa	min. bend radius mm	weight kg
	DN	Inch	Size	mm		max. working pressure MPa	psi	min. burst pressure MPa	psi			
881-12	19	3/4	-12	19,1	30,0	2,1	300	8,3	1200	95	130	0,74
881-16	25	1	-16	25,4	38,0	1,7	250	6,9	1000	95	150	0,89
881-20	31	1 1/4	-20	31,8	45,0	1,4	200	5,5	800	95	200	1,32
881-24	38	1 1/2	-24	38,1	52,0	1,0	150	4,1	600	95	250	1,65
881-32	51	2	-32	50,8	63,0	0,7	100	2,8	400	95	300	1,89
881-40	63	2 1/2	-40	63,5	75,0	0,4	62	1,6	248	95	355	2,71

*1 = los valores de vacío en la tabla son de vacío relativo a presión en kPa. Para valores absolutos, reste el valor en la tabla de 101 kPa. La combinación de alta temperatura y alta presión puede reducir la vida de la manguera.

Ejemplo de layline de manguera

PARKER 881-12 SUCTION HOSE MSHA XXXX SAE 100R4-12 19 mm (3/4) 3Q78 PARKER

RACORES ITALIANOS



Cascillo Prensar

REFERENCIA	SAE100-R1AT DIN-20022-1SN		SAE100-R2AT DIN-20022-2SN	
	GALGA	DIAMETRO INTERIOR	GALGA	DIAMETRO INTERIOR
R103400-03	3/16"	4,8		
R103400-04	1/4"	6,4		
R103400-05	5/16"	7,9		
R103400-06	3/8"	9,5		
R103400-08	1/2"	12,7		
R103400-10	5/8"	15,9		
R103400-12	3/4"	19,1		
R103400-16	1"	25,4		
R103400-20	1-1/4"	31,8		
R103400-24	1-1/2"	38,1		
R103400-32	2"	50,8		

Cascillo Prensar

REFERENCIA	SAE100-R2A DIN-20022-2ST		SAE100-R9R DIN-20023-4SP	
	GALGA	DIAMETRO INTERIOR	GALGA	DIAMETRO INTERIOR
R100900-03	3/16"	4,8		
R100900-04	1/4"	6,4		
R100900-05	5/16"	7,9		
R100900-06	3/8"	9,5		
R100900-08	1/2"	12,7		
R100900-10	5/8"	15,9		
R100900-12	3/4"	19,1		
R100900-16	1"	25,4		
R100900-20	1-1/4"	31,8		
R100900-24	1-1/2"	38,1		
R100900-32	2"	50,8		

Cascillo Prensar

REFERENCIA	SAE100-R7		ISO-3949		DIN-EN-855	
	GALGA	DIAMETRO INTERIOR	GALGA	DIAMETRO INTERIOR	GALGA	DIAMETRO INTERIOR
R100800-03	3/16"	4,8				
R100800-04	1/4"	6,4				
R100800-05	5/16"	7,9				
R100800-06	3/8"	9,5				
R100800-08	1/2"	12,7				

Cascillo Prensar

REFERENCIA	TEFLON		PTFE	
	GALGA	DIAMETRO INTERIOR	GALGA	DIAMETRO INTERIOR
R100500-03	3/16"	4,8		
R100500-04	1/4"	6,4		
R100500-05	5/16"	7,9		
R100500-06	3/8"	9,5		
R100500-08	1/2"	12,7		
R100500-10	5/8"	15,9		
R100500-12	3/4"	19		

Racor Prensar Tuerca Giratoria Recta Gas-Bsp

REFERENCIA	ROSCA	MANGUERA
R120511-03-02	1/8"-28	3/16"
R120511-03-04	1/4"-19	3/16"
R120511-04-04	1/4"-19	1/4"
R120511-04-06	3/8"-19	1/4"
R120511-05-06	3/8"-19	5/16"
R120511-06-06	3/8"-19	3/8"
R120511-04-08	1/2"-14	1/4"
R120511-06-08	1/2"-14	3/8"
R120511-08-08	1/2"-14	1/2"
R120511-08-12	3/4"-14	1/2"
R120511-08-10	5/8"-14	1/2"
R120511-10-10	5/8"-14	5/8"
R120511-10-12	3/4"-14	5/8"
R120511-12-12	3/4"-14	3/4"
R120511-12-16	1"-11	3/4"
R120511-16-16	1"-11	1"
R120511-16-20	1-1/4"-11	1"
R120511-20-20	1-1/4"-11	1-1/4"
R120511-20-24	1-1/2"-11	1-1/4"
R120511-24-24	1-1/2"-11	1-1/2"
R120511-24-32	2"-11	1-1/2"
R120511-32-32	2"	2"

Racor Prensar Macho Fijo Gas-Bsp

REFERENCIA	ROSCA	MANGUERA
R110510-04-02	1/8"-28	1/4"
R110510-03-04	1/4"-19	3/16"
R110510-04-04	1/4"-19	1/4"
R110510-04-06	3/8"-19	1/4"
R110510-05-06	3/8"-19	5/6"
R110510-06-06	3/8"-19	3/8"
R110510-04-08	1/2"-14	1/4"
R110510-06-08	1/2"-14	3/8"
R110510-08-08	1/2"-14	1/2"
R110510-08-10	5/8"-14	1/2"
R110510-10-10	5/8"-14	5/8"
R110510-08-12	3/4"-14	1/2"
R110510-10-12	3/4"-14	5/8"
R110510-12-12	3/4"-14	3/4"
R110510-12-16	1"-11	3/4"
R110510-16-16	1"-11	1"
R110510-16-20	1-1/4"-11	1"
R110510-20-20	1-1/4"-11	1-1/4"
R110510-20-24	1-1/2"-11	1-1/4"
R110510-24-24	1-1/2"-11	1-1/2"
R110510-24-32	2"-11	1-1/2"
R110510-32-32	2"-11	2"

Racor Presar Codo Hembra 90° Gas-Bsp

	REFERENCIA	ROSCA	MANGUERA
	R120591-04-04	1/4"-19	1/4"
	R120591-04-06	3/8"-19	1/4"
	R120591-05-06	3/8"-19	5/6"
	R120591-06-06	3/8"-19	3/8"
	R120591-06-08	1/2"-14	3/8"
	R120591-08-08	1/2"-14	1/2"
	R120591-08-10	5/8"-14	1/2"
	R120591-10-10	5/8"-14	5/8"
	R120591-08-12	3/4"-14	1/2"
	R120591-10-12	3/4"-14	5/8"
	R120591-12-12	3/4"-14	3/4"
	R120591-12-16	1"-11	3/4"
	R120591-16-16	1"-11	1"
	R120591-16-20	1-1/4"-11	1"
	R120591-20-20	1-1/4"-11	1-1/4"
	R120591-20-24	1-1/2"-11	1-1/4"
	R120591-24-24	1-1/2"-11	1-1/2"
	R120591-24-32	2"-11	1-1/2"
	R120591-32-32	2"-11	2"

Racor Presar Codo 45° Hembra Gas-Bsp

	REFERENCIA	ROSCA	MANGUERA
	R120541-04-04	1/4"-19	1/4"
	R120541-04-06	3/8"-19	1/4"
	R120541-05-06	3/8"-19	5/16"
	R120541-06-06	3/8"-19	3/8"
	R120541-06-08	1/2"-14	3/8"
	R120541-08-08	1/2"-14	1/2"
	R120541-08-10	5/8"-14	1/2"
	R120541-10-10	5/8"-14	5/8"
	R120541-08-12	3/4"-14	1/2"
	R120541-10-12	3/4"-14	5/8"
	R120541-12-12	3/4"-14	3/4"
	R120541-12-16	1"-11	3/4"
	R120541-16-16	1"-11	1"
	R120541-16-20	1"-11	1"
	R120541-20-20	1-1/4"-11	1-1/4"
	R120541-20-24	1-1/2"-11	1-1/4"
	R120541-24-24	1-1/2"-11	1-1/2"
	R120541-24-32	2"	2"
	R120541-32-32	2"	2"

Racor Presar Hembra Giratoria Recta Asiento Plano

	REFERENCIA	ROSCA	MANGUERA
	R120611-04-04	1/4"-19	1/4"
	R120611-05-06	3/8"-19	5/16"
	R120611-06-06	3/8"-19	3/8"
	R120611-06-08	1/2"-14	3/8"
	R120611-08-08	1/2"-14	1/2"
	R120611-12-12	3/4"-14	3/4"
	R120611-16-16	1"-11	1"
	R120611-20-20	1-1/4"-11	1-1/4"
	R120611-24	1-1/2"-11	1-1/2"

Racor Presar Esférico Gas-Bsp

	REFERENCIA	ROSCA	MANGUERA
	R129910-04-04	1/4"-19	1/4"
	R129910-04-06	3/8"-19	1/4"
	R129910-05-06	3/8"-19	5/16"
	R129910-06-06	3/8"-19	3/8"
	R129910-06-08	1/2"-14	3/8"
	R129910-08-08	1/2"-14	1/2"
	R129910-08-12	3/4"-14	1/2"
	R129910-08-12	3/4"-14	1/2"
	R129910-10-12	3/4"-14	5/8"
	R129910-12-12	3/4"-14	3/4"
	R129910-12-16	1"-11	1"
	R129910-16-16	1"-11	1"

Racor Presar Esférico Métrico

	REFERENCIA	ROSCA	MANGUERA
	R129910-04-10	M-10X1,5	1/4"
	R129910-04-12	M-12X1,5	1/4"
	R129910-04-14	M-14X1,5	1/4"
	R129910-05-16	M-16X1,5	5/16"
	R129910-06-16	M-16X1,5	3/8"
	R129910-04-18	M-18X1,5	1/4"
	R129910-06-18	M-18X1,5	3/8"
	R129910-08-18	M-18X1,5	1/2"
	R129910-06-20	M-20X1,5	3/8"
	R129910-08-22	M-22X1,5	1/2"
	R129910-10-26	M-26X1,5	5/8"
	R129910-12-26	M-26X1,5	3/4"
	R129910-12-30	M-30X2	3/4"

Racor Presar Macho Cónico BSPT

	REFERENCIA	ROSCA	MANGUERA
	R110710-04-02	1/8"-28	1/4"
	R110710-04-04	1/4"-19	1/4"
	R110710-04-06	3/8"-19	1/4"
	R110710-05-06	3/8"-19	5/16"
	R110710-06-06	3/8"-19	3/8"
	R110710-06-08	1/2"-14	3/8"
	R110710-08-08	1/2"-14	1/2"
	R110710-10-10	5/8"-14	5/8"
	R110710-10-12	3/4"-14	5/8"
	R110710-12-12	3/4"-14	3/4"
	R110710-12-16	1"-11	3/4"
	R110710-16-16	1"-11	1"
	R110710-16-20	1-1/4"-11	1"
	R110710-20-20	1-1/4"-11	1-1/4"
	R110710-24-24	1-1/2"-11	1-1/2"
	R110710-32-32	2"-11	2"

Racor Presar Macho Cónico NPT

REFERENCIA	ROSCA	MANGUERA
R112810-04-02	1/8"-27	1/4"
R112810-04-04	1/4"-18	1/4"
R112810-05-06	3/8"-18	5/16"
R112810-06-06	3/8"-18	3/8"
R112810-06-08	1/2"-14	3/8"
R112810-08-08	1/2"-14	1/2"
R112810-10-12	3/4"-14	5/8"
R112810-12-12	3/4"-14	3/4"
R112810-12-16	1"-11,5	3/4"
R112810-16-16	1"-11,5	1"
R112810-16-20	1-1/4"-11,5	1-1/4"
R112810-20-20	1-1/4"-11,5	1-1/4"
R112810-24-24	1-1/2"-11,5	1-1/2"
R112810-32-32	2"-11,5	2"

Racor Presar Espiga Lisa

REFERENCIA	DIAMETRO	MANGUERA
R122010-04-06	6	1/4"
R122010-04-08	8	1/4"
R122010-04-10	10	1/4"
R122010-05-10	10	5/16"
R122010-06-10	10	3/8"
R122010-04-12	12	1/4"
R122010-05-12	12	5/16"
R122010-06-12	12	3/8"
R122010-06-14	14	3/8"
R122010-08-14	14	1/2"
R122010-08-15	15	1/2"
R122010-08-16	16	1/2"
R122010-08-18	18	1/2"
R122010-10-18	18	5/8"
R122010-08-20	20	1/2"
R122010-10-20	20	5/8"
R122010-10-22	22	5/8"
R122010-12-22	22	3/4"
R122010-12-25	25	3/4"
R122010-16-25	25	1"
R122010-16-28	28	1"
R122010-16-30	30	1"
R122010-20-30	30	1-1/4"
R122010-20-35	35	1-1/4"
R122010-20-38	38	1-1/4"
R122010-24-42	42	1-1/2"

Racor Presar 90° Espiga Lisa

REFERENCIA	DIAMETRO	MANGUERA
R122090-04-06	6	1/4"
R122090-04-08	8	1/4"
R122090-04-10	10	1/4"
R122090-05-10	10	5/16"
R122090-06-10	10	3/8"
R122090-05-12	12	5/16"
R122090-06-12	12	3/8"
R122090-06-14	14	3/8"
R122090-08-14	14	1/2"
R122090-08-15	15	1/2"
R122090-08-16	16	1/2"
R122090-10-18	18	5/8"
R122090-10-20	20	5/8"
R122090-12-20	20	3/4"
R122090-12-22	22	3/4"
R122090-12-25	25	3/4"
R122090-16-28	28	1"
R122090-16-30	30	1"
R122090-20-35	35	1-1/4"

Racor Presar 45° Espiga Lisa

REFERENCIA	DIAMETRO	MANGUERA
R122040-04-06	6	1/4"
R122040-04-08	8	1/4"
R122040-04-10	10	1/4"
R122040-05-10	10	5/16"
R122040-06-10	10	3/8"
R122040-05-12	12	5/16"
R122040-06-12	12	3/8"
R122040-06-14	14	3/8"
R122040-08-14	14	1/2"
R122040-08-15	15	1/2"
R122040-08-16	16	1/2"
R122040-10-18	18	5/8"
R122040-10-20	20	5/8"
R122040-12-20	20	3/4"
R122040-12-22	22	3/4"
R122040-12-25	25	3/4"
R122040-16-28	28	1"
R122040-16-30	30	1"
R122040-20-35	35	1-1/4"

Racor Presar Tuerca Hidrolavadoras

REFERENCIA	ROSCA	MANGUERA
R124913-04-22	M-22X1,5	1/4"
R124913-05-22	M-22X1,5	5/16"
R124913-06-22	M-22X1,5	3/8"

Racor Presar Hembra Métrica Cono 60°

REFERENCIA	ROSCA	MANGUERA
R111010-04-12	M-12X1,5	1/4"
R111010-04-14	M-14X1,5	1/4"
R111010-05-16	M-16X1,5	5/16"
R111010-06-18	M-18X1,5	3/8"
R111010-08-22	M-22X1,5	1/2"
R111010-10-26	M-26X1,5	5/8"
R111010-12-30	M-30X1,5	3/4"
R111010-16-38	M-38X1,5	1"
R111010-20-45	M-45X1,5	1-1/4"

Racor Prensar Hembra Métrica Cono 60°

	REFERENCIA	ROSCA	MANGUERA
	R121013-12-30	M-30X1,5	3/4"
	R121013-16-38	M-38X1,5	1"
	R121013-20-45	M-45X1,5	1-1/4"
	R121013-24-52	M-52X1,5	1-1/2"

Racor Prensar Codo 90° Hembra Métrica Cono 60°

	REFERENCIA	ROSCA	MANGUERA
	R121093-12-30	M-30X1,5	3/4"
	R121093-16-38	M-38X1,5	1"
	R121093-20-45	M-45X1,5	1-1/4"
	R121093-24-52	M-52X1,5	1-1/2"

Racor Prensar Codo 45° Hembra Métrica Cono 60°

	REFERENCIA	ROSCA	MANGUERA
	R121043-12-30	M-30X1,5	3/4"
	R121043-16-38	M-38X1,5	1"
	R121043-20-45	M-45X1,5	1-1/4"
	R121043-24-52	M-52X1,5	1-1/2"

Racor Prensar Macho Métrico Serie Ligera Din 2353

	REFERENCIA	TUBULAR	ROSCA	MANGUERA
	R111110-04-12	6L	M-12X1,5	1/4"
	R111110-04-14	8L	M-14X1,5	1/4"
	R111110-04-16	10L	M-16X1,5	1/4"
	R111110-05-16	10L	M-16X1,5	5/16"
	R111110-06-18	12L	M-18X1,5	3/8"
	R111110-08-22	15L	M-22X1,5	1/2"
	R111110-10-26	18L	M-26X1,5	5/8"
	R111110-12-30	22L	M-30X2	3/4"
	R111110-16-36	28L	M-36X2	1"
	R111110-20-45	35L	M-45X2	1-1/4"
	R111110-24-52	42L	M-52X2	1-1/2"

Racor Prensar Hembra Recta Métrico Serie Ligera Din 2353

	REFERENCIA	TUBULAR	ROSCA	MANGUERA
	R121513-04-12	6L	M-12X1,5	1/4"
	R121513-04-14	8L	M-14X1,5	1/4"
	R121513-04-16	10L	M-16X1,5	1/4"
	R121513-05-16	10L	M-16X1,5	5/16"
	R121513-06-18	12L	M-18X1,5	3/8"
	R121513-08-22	15L	M-22X1,5	1/2"
	R121513-10-26	18L	M-26X1,5	5/8"
	R121513-12-30	22L	M-30X2	3/4"
	R121513-16-36	28L	M-36X2	1"
	R121513-20-45	35L	M-45X2	1-1/4"
	R121513-24-52	42L	M-52X2	1-1/2"

Racor Prensar Codo 90° Métrico Serie Ligera Din 2353

	REFERENCIA	TUBULAR	ROSCA	MANGUERA
	R121593-04-12	6L	M-12X1,5	1/4"
	R121593-04-14	8L	M-14X1,5	1/4"
	R121593-04-16	10L	M-16X1,5	1/4"
	R121593-05-16	10L	M-16X1,5	5/16"
	R121593-06-18	12L	M-18X1,5	3/8"
	R121593-08-22	15L	M-22X1,5	1/2"
	R121593-10-26	18L	M-26X1,5	5/8"
	R121593-12-30	22L	M-30X2	3/4"
	R121593-16-36	28L	M-36X2	1"
	R121593-20-45	35L	M-45X2	1-1/4"
	R121593-24-52	42L	M-52X2	1-1/2"

Racor Prensar Codo 45° Métrico Serie Pesada Din 2353

	REFERENCIA	TUBULAR	ROSCA	MANGUERA
	R121543-04-14	8L	M-14X1,5	1/4"
	R121543-05-16	10L	M-16X1,5	5/16"
	R121543-06-18	12L	M-18X1,5	3/8"
	R121543-08-22	15L	M-22X1,5	1/2"
	R121543-10-26	18L	M-26X1,5	5/8"
	R121543-12-30	22L	M-30X2	3/4"
	R121543-16-36	28L	M-36X2	1"
R121543-20-45	35L	M-45X2	1-1/4"	
R121543-24-52	42L	M-52X2	1-1/2"	

Racor Prensar Macho Métrico Serie Pesada Din 2353

	REFERENCIA	TUBULAR	ROSCA	MANGUERA
	R111210-04-16	8S	M-16X1,5	1/4"
	R111210-04-18	10S	M-18X1,5	1/4"
	R111210-05-20	12S	M-20X1,5	5/16"
	R111210-06-20	12S	M-20X1,5	3/8"
	R111210-06-22	14S	M-22X1,5	3/8"
	R111210-08-24	16S	M-24X1,5	1/2"
	R111210-10-30	20S	M-30X2	5/8"
	R111210-12-36	25S	M-36X2	3/4"
	R111210-16-42	30S	M-42X2	1"
	R111210-20-52	38S	M-52X2	1-1/4"

Racor Prensar Recta Métrica Serie Pesada DIN 2353

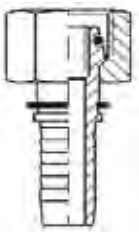
	REFERENCIA	TUBULAR	ROSCA	MANGUERA
	R121613-04-18	10S	M-18X1,5	1/4"
	R121613-05-20	12S	M-20X1,5	5/16"
	R121613-06-20	12S	M-20X1,5	3/8"
	R121613-06-22	14S	M-22X1,5	3/8"
	R121613-08-24	16S	M-24X1,5	1/2"
	R121613-10-30	20S	M-30X2	5/8"
	R121613-12-36	25S	M-36X2	3/4"
	R121613-16-42	30S	M-42X2	1"
	R121613-20-52	38S	M-52X2	1-1/4"

Racor Prensar Hembra Codo 90° Métrica Serie Pesada DIN 2353

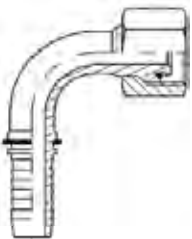
	REFERENCIA	TUBULAR	ROSCA	MANGUERA
	R121693-04-18	10S	M-18X1,5	1/4"
	R121693-05-20	12S	M-20X1,5	5/16"
	R121693-06-20	12S	M-20X1,5	3/8"
	R121693-06-22	14S	M-22X1,5	3/8"
	R121693-08-24	16S	M-24X1,5	1/2"
	R121693-10-30	20S	M-30X2	5/8"
	R121693-12-36	25S	M-36X2	3/4"
	R121693-16-42	30S	M-42X2	1"
	R121693-20-52	38S	M-52X2	1-1/4"

Racor Prensar Hembra Codo 45° Métrica Serie Pesada DIN 2353

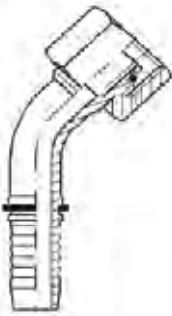
	REFERENCIA	TUBULAR	ROSCA	MANGUERA
	R121643-04-18	10S	M-18X1,5	1/4"
	R121643-05-20	12S	M-20X1,5	5/16"
	R121643-06-20	12S	M-20X1,5	3/8"
	R121643-06-22	14S	M-22X1,5	3/8"
	R121643-08-24	16S	M-24X1,5	1/2"
	R121643-10-30	20S	M-30X2	5/8"
	R121643-12-36	25S	M-36X2	3/4"
	R121643-16-42	30S	M-42X2	1"
	R121643-20-52	38S	M-52X2	1-1/4"

Racor Prensar Macho Métrico Serie Francesa Tubo Gas

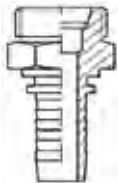
	REFERENCIA	TUBULAR	ROSCA	MANGUERA
	R111710-04-20	13,25	M-20X1,5	1/4"
	R111710-05-20	13,25	M-20X1,5	5/16"
	R111710-06-20	13,25	M-20X1,5	3/8"
	R111710-06-24	16,75	M-24X1,5	3/8"
	R111710-08-24	16,75	M-24X1,5	1/2"
	R111710-08-30	21,25	M-30X1,5	1/2"
	R111710-10-30	21,25	M-30X1,5	5/8"
	R111710-12-30	21,25	M-30X1,5	3/4"
	R111710-12-36	26,75	M-36X1,5	3/4"
	R111710-16-45	33,5	M-45X1,5	1"
	R111710-20-45	33,5	M-45X1,5	1-1/4"

Racor Prensar Hembra Recta Métrico Serie Francesa Turbo Gas

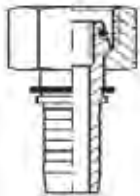
	REFERENCIA	TUBULAR	ROSCA	MANGUERA
	R121713-04-20	13,25	M-20X1,5	1/4"
	R121713-05-20	13,25	M-20X1,5	5/16"
	R121713-06-20	13,25	M-20X1,5	3/8"
	R121713-06-24	16,75	M-24X1,5	3/8"
	R121713-08-24	16,75	M-24X1,5	1/2"
	R121713-08-30	21,25	M-30X1,5	1/2"
	R121713-10-30	21,25	M-30X1,5	5/8"
	R121713-12-30	21,25	M-30X1,5	3/4"
	R121713-12-36	26,75	M-36X1,5	3/4"
	R121713-16-45	33,5	M-45X1,5	1"
	R121713-20-45	33,5	M-45X1,5	1-1/4"

Racor Prensar Hembra Codo 90° Metrico Serie Francesa Tubo Gas

REFERENCIA	TUBULAR	ROSCA	MANGUERA
R121793-04-20	13,25	M-20X1,5	1/4"
R121793-05-20	13,25	M-20X1,5	5/16"
R121793-06-20	13,25	M-20X1,5	3/8"
R121793-06-24	16,75	M-24X1,5	3/8"
R121793-08-24	16,75	M-24X1,5	1/2"
R121793-08-30	21,25	M-30X1,5	1/2"
R121793-10-30	21,25	M-30X1,5	5/8"
R121793-12-30	21,25	M-30X1,5	3/4"
R121793-12-36	26,75	M-36X1,5	3/4"
R121793-16-45	33,5	M-45X1,5	1"
R121793-20-45	33,5	M-45X1,5	1-1/4"

Racor Prensar Hembra Codo 45° Metrico Serie Francesa Tubo Gas

REFERENCIA	TUBULAR	ROSCA	MANGUERA
R121743-04-20	13,25	M-20X1,5	1/4"
R121743-05-20	13,25	M-20X1,5	5/16"
R121743-06-20	13,25	M-20X1,5	3/8"
R121743-06-24	16,75	M-24X1,5	3/8"
R121743-08-24	16,75	M-24X1,5	1/2"
R121743-08-30	21,25	M-30X1,5	1/2"
R121743-10-30	21,25	M-30X1,5	5/8"
R121743-12-30	21,25	M-30X1,5	3/4"
R121743-12-36	26,75	M-36X1,5	3/4"
R121743-16-45	33,5	M-45X1,5	1"
R121743-16-45	33,5	M-45X1,5	1-1/4"

Racor Prensar Hembra Recta Métrica Komatsu

REFERENCIA	ROSCA	MANGUERA
R124011-04-14	M-14X1,5	1/4"
R124011-05-16	M-16X1,5	5/16"
R124011-06-14	M-14X1,5	3/8"
R124011-06-18	M-18X1,5	3/8"
R124011-08-22	M-22X1,5	1/2"
R124011-10-24	M-24X1,5	5/8"
R124011-12-30	M-30X1,5	3/4"
R124011-16-33	M-33X1,5	1"
R124011-20-36	M-36X1,5	1-1/4"
R124011-24-42	M-42X1,5	1-1/2"

Racor Prensar Hembra Recta Bsp-Gas Cono 45° Toyota

REFERENCIA	ROSCA	MANGUERA
R123811-04-04	1/4"-19	1/4"
R123811-06-06	3/8"-19	3/8"
R123811-08-08	1/2"-14	1/2"
R123811-12-12	3/4"-14	3/4"
R123811-16-16	1"-11	1"
R123811-20-20	1-1/4"-11	1-1/4"
R123811-24-24	1-1/2"-11	1-1/2"

Racor Prensar Macho Jic Cono 37°

REFERENCIA	ROSCA	MANGUERA
R112510-04-04	7/16"-20	1/4"
R112510-04-05	1/2"-20	1/4"
R112510-04-06	9/16"-18	1/4"
R112510-05-06	9/16"-18	5/16"
R112510-06-06	9/16"-18	3/8"
R112510-06-08	3/4"-16	3/8"
R112510-08-08	3/4"-16	1/2"
R112510-08-10	7/8"-14	1/2"
R112510-08-12	1-1/16"-12	1/2"
R112510-10-10	7/8"-14	5/8"
R112510-10-12	1-1/16"-12	5/8"
R112510-12-12	1-1/16"-12	3/4"
R112510-12-16	1-5/16"-12	3/4"
R112510-16-16	1-5/16"-12	1"
R112510-20-20	1-5/8"-12	1-1/4"
R112510-24-24	1-7/8"-12	1-1/2"
R112510-32-32	2-1/2"-12	2"

Racor Hembra Recta Jic Cono 37°

REFERENCIA	ROSCA	MANGUERA
R122511-04-04	7/16"-20	1/4"
R122511-04-05	1/2"-20	1/4"
R122511-04-06	9/16"-18	1/4"
R122511-05-06	9/16"-18	5/16"
R122511-06-06	9/16"-18	3/8"
R122511-06-08	3/4"-16	3/8"
R122511-08-08	3/4"-16	1/2"
R122511-08-10	7/8"-14	1/2"
R122511-10-10	7/8"-14	5/8"
R122511-08-12	1-1/16"-12	1/2"
R122511-10-12	1-1/16"-12	5/8"
R122511-12-12	1-1/16"-12	3/4"
R122511-12-16	1-5/16"-12	3/4"
R122511-16-16	1-5/16"-12	1"
R122511-20-20	1-5/8"-12	1-1/4"
R122511-24-24	1-7/8"-12	1-1/2"
R122511-32-32	2-1/2"-12	2"

Racor Prensar Codo 90° Hembra Jic Cono 37°

REFERENCIA	ROSCA	MANGUERA
R122591-04-04	7/16"-20	1/4"
R122591-04-05	1/2"-20	1/4"
R122591-04-06	9/16"-18	1/4"
R122591-05-06	9/16"-18	5/16"
R122591-06-06	9/16"-18	3/8"
R122591-06-08	3/4"-16	3/8"
R122591-08-08	3/4"-16	1/2"
R122591-08-10	7/8"-14	1/2"
R122591-10-10	7/8"-14	5/8"
R122591-08-12	1-1/16"-12	1/2"
R122591-10-12	1-1/16"-12	5/8"
R122591-12-12	1-1/16"-12	3/4"
R122590-12-16	1-5/16"-12	3/4"
R122591-16-16	1-5/16"-12	1"
R122591-20-20	1-5/8"-12	1-1/4"
R122591-24-24	1-7/8"-12	1-1/2"
R122591-32-32	2-1/2"-12	2"

Racor Prensar Codo 45° Hembra Jic Cono 37°

REFERENCIA	ROSCA	MANGUERA
R122541-04-04	7/16"-20	1/4"
R122541-04-05	1/2"-20	1/4"
R122541-04-06	9/16"-18	1/4"
R122541-05-06	9/16"-18	5/16"
R122541-06-06	9/16"-18	3/8"
R122541-06-08	3/4"-16	3/8"
R122541-08-08	3/4"-16	1/2"
R122541-08-10	7/8"-14	1/2"
R122541-10-10	7/8"-14	5/8"
R122541-08-12	1-1/16"-12	1/2"
R122541-10-12	1-1/16"-12	5/8"
R122541-12-12	1-1/16"-12	3/4"
R122541-12-16	1-5/16"-12	3/4"
R122541-16-16	1-5/16"-12	1"
R122541-20-20	1-5/8"-12	1-1/4"
R122541-24-24	1-7/8"-12	1-1/2"
R122541-32-32	2-1/2"-12	2"

Racor Prensar Macho Orfs ISO 12151-1

REFERENCIA	ROSCA	MANGUERA
R112410-04-04	9/16"-18	1/4"
R112410-06-06	11/16"-16	3/8"
R112410-08-08	13/16"-16	1/2"
R112410-10-10	1"-14	5/8"
R112410-12-12	1-3/16"-12	3/4"
R112410-16-16	1-7/16"-12	1"
R112410-20-20	1-11/16"-12	1-1/4"

Racor Prensar Hembra Orfs ISO 12151-1

REFERENCIA	ROSCA	MANGUERA
R122413-04-04	9/16"-18	1/4"
R122413-05-06	11/16"-16	5/16"
R122413-06-06	11/16"-16	3/8"
R122413-08-08	13/16"-16	1/2"
R122413-10-10	1"-14	5/8"
R122413-12-12	1-3/16"-12	3/4"
R122413-16-16	1-7/16"-12	1"
R122413-20-20	1-11/16"-12	1-1/4"
R122413-24-24	2"-12	1-1/2"

Racor Prensar Hembra Codo 90° Orfs ISO 12151-1

REFERENCIA	ROSCA	MANGUERA
R122493-04-04	9/16"-18	1/4"
R122493-05-06	11/16"-16	5/16"
R122493-06-06	11/16"-16	3/8"
R122493-08-08	13/16"-16	1/2"
R122493-10-10	1"-14	5/8"
R122493-12-12	1-3/16"-12	3/4"
R122493-16-16	1-7/16"-12	1"
R122493-20-20	1-11/16"-12	1-1/4"
R122493-24-24	2"-12	1-1/2"

Racor Prensar Hembra Codo 45° Orfs ISO 12151-1

REFERENCIA	ROSCA	MANGUERA
R122443-04-04	9/16"-18	1/4"
R122443-05-06	11/16"-16	5/16"
R122443-06-06	11/16"-16	3/8"
R122443-08-08	13/16"-16	1/2"
R122443-10-10	1"-14	5/8"
R122443-12-12	1-3/16"-12	3/4"
R122443-16-16	1-7/16"-12	1"
R122443-20-20	1-11/16"-12	1-1/4"
R122443-24-24	2"-12	1-1/2"

Racor Prensar Brida Recta Sae 3000 PSI

REFERENCIA	DIAMETRO	MANGUERA
R123311-08-08	30,2	1/2"
R123311-08-12	38,1	1/2"
R123311-12-12	38,1	3/4"
R123311-12-16	44,5	3/4"
R123311-16-16	44,5	1"
R123311-16-20	50,8	1"
R123311-20-20	50,8	1-1/4"
R123311-20-24	60,3	1-1/4"
R123311-24-24	60,3	1-1/2"
R123311-24-32	71,4	1-1/2"
R123311-32-32	71,4	2"

Racor Prensar Brida Codo 90° Sae 3000 PSI

REFERENCIA	DIAMETRO	MANGUERA
R123391-08-08	30,2	1/2"
R123391-08-12	38,1	1/2"
R123391-12-12	38,1	3/4"
R123391-12-16	44,5	3/4"
R123391-16-16	44,5	1"
R123391-16-20	50,8	1"
R123391-20-20	50,8	1-1/4"
R123391-20-24	60,3	1-1/4"
R123391-24-24	60,3	1-1/2"
R123391-24-32	71,4	1-1/2"
R123391-32-32	71,4	2"

**Racor Prensar Brida Codo 45°
Sae 3000 PSI**

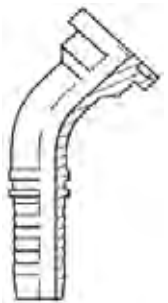
	REFERENCIA	DIAMETRO	MANGUERA
	R123341-08-08	30,2	1/2"
	R123341-08-12	38,1	1/2"
	R123341-12-12	38,1	3/4"
	R123341-12-16	44,5	3/4"
	R123341-16-16	44,5	1"
	R123341-16-20	50,8	1"
	R123341-20-20	50,8	1-1/4"
	R123341-20-24	60,3	1-1/4"
	R123341-24-24	60,3	1-1/2"
	R123341-24-32	71,4	1-1/2"
R123341-32-32	71,4	2"	

**Racor Brica Recta Sae
6000 PSI**

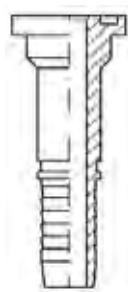
	REFERENCIA	DIAMETRO	MANGUERA
	R123611-08-08	31,8	1/2"
	R123611-08-12	41,3	1/2"
	R123611-12-12	41,3	3/4"
	R123611-12-16	47,6	3/4"
	R123611-16-16	47,6	1"
	R123611-16-20	54	1"
	R123611-20-20	54	1-1/4"
	R123611-20-24	63,5	1-1/4"
	R123611-24-24	63,5	1-1/2"
	R123611-24-32	79,4	1-1/2"
R123611-32-32	79,4	2"	

**Racor Prensar Codo 90° Brida
Sae 6000 PSI**

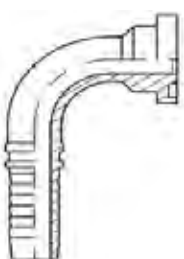
	REFERENCIA	DIAMETRO	MANGUERA
	R123691-08-08	31,8	1/2"
	R123691-08-12	41,3	1/2"
	R123691-12-12	41,3	3/4"
	R123691-12-16	47,6	3/4"
	R123691-16-16	47,6	1"
	R123691-16-20	54	1"
	R123691-20-20	54	1-1/4"
	R123691-20-24	63,5	1-1/4"
	R123691-24-24	63,5	1-1/2"
	R123691-24-32	79,4	1-1/2"
R123691-32-32	79,4	2"	

**Racor Prensar Codo 45° Brida
Sae 6000 PSI**

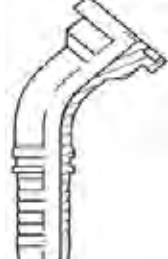
	REFERENCIA	DIAMETRO	MANGUERA
	R123641-08-08	31,8	1/2"
	R123641-08-12	41,3	1/2"
	R123641-12-12	41,3	3/4"
	R123641-12-16	47,6	3/4"
	R123641-16-16	47,6	1"
	R123641-16-20	54	1"
	R123641-20-20	54	1-1/4"
	R123641-20-24	63,5	1-1/4"
	R123641-24-24	63,5	1-1/2"
	R123641-24-32	79,4	1-1/2"
R123641-32-32	79,4	2"	

Semibridas Sae 3000 Psi ISO 6162-1/2

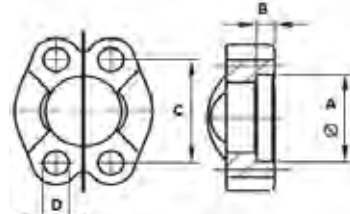
	REFERENCIA	A	B	C	D
	R183308-08	31	6,2	38,1	8,8
	R183308-12	38,9	6,2	47,6	10,5
	R183308-16	45,2	7,5	52,4	10,5
	R183308-20	51,6	7,5	58,7	10,5
	R183308-24	61,1	7,5	69,9	13,5
	R183308-32	72,3	9	77,8	14,5
	R183308-40	84,9	9	88,9	14,5

Semibridas Sae 6000 PSI ISO 6162-1/2

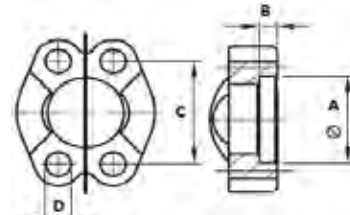
	REFERENCIA	A	B	C	D
	R183609-08	32,5	7,2	40,5	8,8
	R183609-12	42	8,3	50,8	10,5
	R183609-16	48,4	9	57,2	13
	R183609-20	54,8	9,8	66,6	15
	R183609-24	64,3	12,1	79,3	17
	R183609-32	80,2	12,1	96,8	21
	R183609-40	108,9	20,5	123,8	25

RACORES SERIE 16



CA Hembra giratoria métrica 24° Serie ligera con junta tórica Recta

ISO 12151-2-SWS-L – DKOL

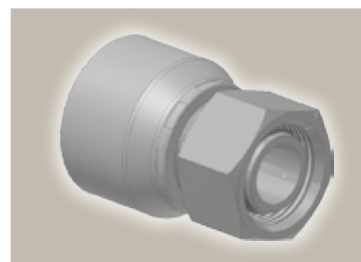
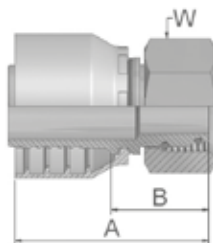

Referencia	D.I. de manguera				Rosca métrica	Tubo D.E. mm	A mm	B mm	W mm
	DN	Pulg.	Tamaño	mm					
1CA16-6-4	6	1/4	-4	6,4	M12x1,5	6	45	22	14
1CA16-8-4	6	1/4	-4	6,4	M14x1,5	8	44	22	17
1CA16-10-4	6	1/4	-4	6,4	M16x1,5	10	45	22	19
1CA16-10-5	8	5/16	-5	7,9	M16x1,5	10	45	22	19
1CA16-12-5	8	5/16	-5	7,9	M18x1,5	12	45	22	22
1CA16-10-6	10	3/8	-6	9,5	M16x1,5	10	46	23	19
1CA16-12-6	10	3/8	-6	9,5	M18x1,5	12	45	23	22
1CA16-15-8	12	1/2	-8	12,7	M22x1,5	15	50	26	27
1CA16-18-10	16	5/8	-10	15,9	M26x1,5	18	50	25	32
1CA16-18-12	19	3/4	-12	19,1	M26x1,5	18	51	25	32
1CA16-22-12	19	3/4	-12	19,1	M30x2	22	56	30	36
1CA16-28-16	25	1	-16	25,4	M36x2	28	63	33	41

Los terminales se entregan con junta tórica de Nitrilo (NBR) resistente al ozono como versión estándar. La temperatura de trabajo desde -40 °C hasta +105 °C. Disponibles a petición terminales con juntas tóricas especiales (Vitón o EPDM).

CE Hembra giratoria métrica 24° Serie ligera con junta tórica Codo 45°

ISO 12151-2-SWE 45°-L – DKOL 45°

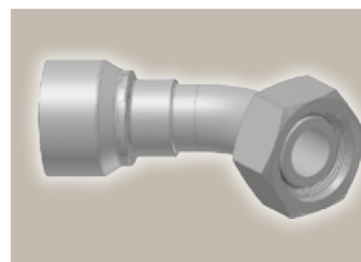
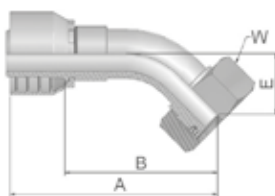

Referencia	D.I. de manguera				Rosca métrica	Tubo D.E. mm	A mm	B mm	E mm	W mm
	DN	Pulg.	Tamaño	mm						
1CE16-6-4	6	1/4	-4	6,4	M12x1,5	6	68	45	19	14
1CE16-8-4	6	1/4	-4	6,4	M14x1,5	8	57	35	16	17
1CE16-10-4	6	1/4	-4	6,4	M16x1,5	10	58	35	16	19
1CE16-10-5	8	5/16	-5	7,9	M16x1,5	10	66	44	15	19
1CE16-12-5	8	5/16	-5	7,9	M18x1,5	12	60	37	16	22
1CE16-12-6	10	3/8	-6	9,5	M18x1,5	12	68	45	19	22
1CE16-15-8	12	1/2	-8	12,7	M22x1,5	15	71	47	22	27
1CE16-18-10	16	5/8	-10	15,9	M26x1,5	18	75	50	23	32
1CE16-22-12	19	3/4	-12	19,1	M30x2	22	88	62	26	36
1CE16-28-16	25	1	-16	25,4	M36x 2	28	113	83	33	41

Los terminales se entregan con junta tórica de Nitrilo (NBR) resistente al ozono como versión estándar. La temperatura de trabajo desde -40 °C hasta +105 °C. Disponibles a petición terminales con juntas tóricas especiales (Vitón o EPDM).

Serie de terminales aprobados para tipos de manguera:

16 BCH1 | BCH2

CF Hembra giratoria métrica 24° Serie ligera con junta tórica Codo 90°

ISO 12151-2-SWE-L – DKOL 90°

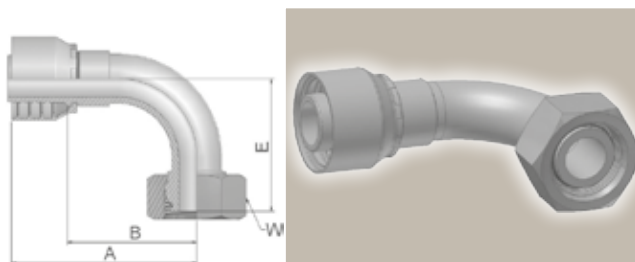

Referencia	D.I. de manguera				Rosca métrica	Tubo D.E. mm	A mm	B mm	E mm	W mm
	DN	Pulg.	Tamaño	mm						
1CF16-6-4	6	1/4	-4	6,4	M12x1,5	6	55	33	33	14
1CF16-8-4	6	1/4	-4	6,4	M14x1,5	8	49	27	29	17
1CF16-10-4	6	1/4	-4	6,4	M16x1,5	10	50	28	29	19
1CF16-10-5	8	5/16	-5	7,9	M16x1,5	10	60	37	29	19
1CF16-12-5	8	5/16	-5	7,9	M18x1,5	12	59	37	30	22
1CF16-10-6	10	3/8	-6	9,5	M16x1,5	10	60	37	37	19
1CF16-12-6	10	3/8	-6	9,5	M18x1,5	12	58	35	35	22
1CF16-15-8	12	1/2	-8	12,7	M22x1,5	15	61	37	43	27
1CF16-18-10	16	5/8	-10	15,9	M26x1,5	18	66	41	45	32
1CF16-18-12	19	3/4	-12	19,1	M26x1,5	18	80	54	56	32
1CF16-22-12	19	3/4	-12	19,1	M30x2	22	80	54	55	36
1CF16-28-16	25	1	-16	25,4	M36x2	28	101	72	71	41

Los terminales se entregan con junta tórica de Nitrilo (NBR) resistente al ozono como versión estándar. La temperatura de trabajo desde -40 °C hasta +105 °C. Disponibles a petición terminales con juntas tóricas especiales (Vitón o EPDM).

DO Macho métrico recto 24° Serie ligera – Recta

ISO 12151-2-S-L – CEL

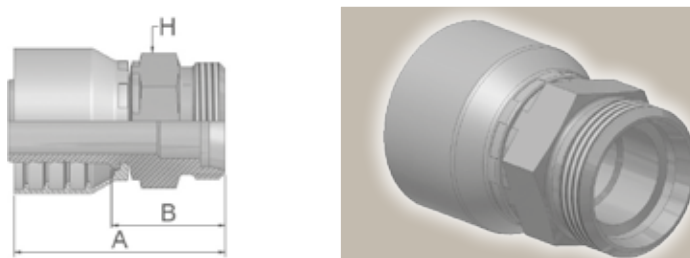

Referencia	D.I. de manguera				Rosca métrica	Tubo D.E. mm	A mm	B mm	H mm
	DN	Pulg.	Tamaño	mm					
1D016-6-4	6	1/4	-4	6,4	M12x1,5	6	43	20	12
1D016-8-4	6	1/4	-4	6,4	M14x1,5	8	44	22	14
1D016-10-5	8	5/16	-5	7,9	M16x1,5	10	46	24	17
1D016-10-6	10	3/8	-6	9,5	M16x1,5	10	47	24	17
1D016-12-6	10	3/8	-6	9,5	M18x1,5	12	47	24	19
1D016-15-8	12	1/2	-8	12,7	M22x1,5	15	50	26	22
1D016-22-12	19	3/4	-12	19,1	M30x2	22	59	33	30
1D016-28-16	25	1	-16	25,4	M36x2	28	65	35	36

Serie de terminales aprobados para tipos de manguera:

16 BCH1 BCH2

C9 Hembra giratoria métrica 24° Serie pesada con junta tórica Recta

ISO 12151-2-SWS-S – DKOS

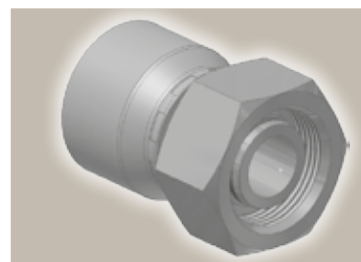
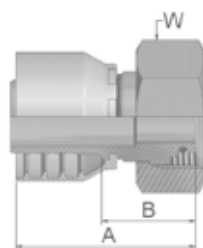

Referencia	D.I. de manguera				Rosca métrica	Tubo D.E. mm	A mm	B mm	W mm
	DN	Pulg.	Tamaño	mm					
1C916-8-4	6	1/4	-4	6,4	M16x1,5	8	45	23	19
1C916-10-4	6	1/4	-4	6,4	M18x1,5	10	44	22	22
1C916-10-5	8	5/16	-5	7,9	M18x1,5	10	45	22	22
1C916-12-5	8	5/16	-5	7,9	M20x1,5	12	47	24	24
1C916-10-6	10	3/8	-6	9,5	M18x1,5	10	45	23	22
1C916-12-6	10	3/8	-6	9,5	M20x1,5	12	47	24	24
1C916-16-8	12	1/2	-8	12,7	M24x1,5	16	51	28	30
1C916-20-10	16	5/8	-10	15,9	M30x2	20	53	28	36
1C916-20-12	19	3/4	-12	19,1	M30x2	20	56	30	36
1C916-25-12	19	3/4	-12	19,1	M36x2	25	61	35	46
1C916-30-16	25	1	-16	25,4	M42x2	30	67	38	50

Los terminales se entregan con junta tórica de Nitrilo (NBR) resistente al ozono como versión estándar. La temperatura de trabajo desde -40 °C hasta +105 °C. Disponibles a petición terminales con juntas tóricas especiales (Vitón o EPDM).

OC Hembra giratoria métrica 24° Series pesada con junta tórica Codo 45°

ISO 12151-2 – SWE 45°-S – DKOS 45°

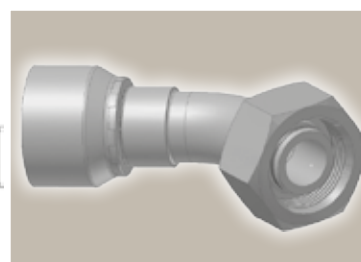
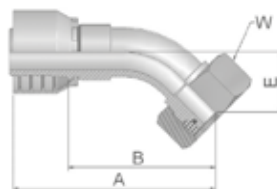

Referencia	D.I. de manguera				Rosca métrica	Tubo D.E. mm	A mm	B mm	E mm	W mm
	DN	Pulg.	Tamaño	mm						
10C16-8-4	6	1/4	-4	6,4	M16x1,5	8	58	35	16	19
10C16-10-4	6	1/4	-4	6,4	M18x1,5	10	57	35	16	22
10C16-10-5	8	5/16	-5	7,9	M18x1,5	10	60	38	17	22
10C16-12-5	8	5/16	-5	7,9	M20x1,5	12	69	47	17	24
10C16-12-6	10	3/8	-6	9,5	M20x1,5	12	69	46	20	24
10C16-16-8	12	1/2	-8	12,7	M24x1,5	16	72	49	23	30
10C16-20-10	16	5/8	-10	15,9	M30x2	20	76	51	25	36
10C16-20-12	19	3/4	-12	19,1	M30x2	20	90	64	28	36
10C16-25-12	19	3/4	-12	19,1	M36x2	25	91	66	29	46
10C16-30-16	25	1	-16	25,4	M42x2	30	115	86	36	50

Los terminales se entregan con junta tórica de Nitrilo (NBR) resistente al ozono como versión estándar. La temperatura de trabajo desde -40 °C hasta +105 °C. Disponibles a petición terminales con juntas tóricas especiales (Vitón o EPDM).

Serie de terminales aprobados para tipos de manguera:

16 BCH1 | BCH2

1C Hembra giratoria métrica 24° Serie pesada con junta tórica Codo 90°

ISO 12151-2-SWE-S – DKOS 90°

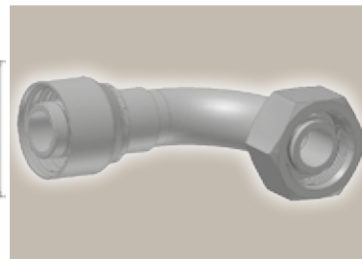
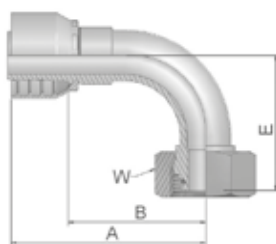

Referencia	D.I. de manguera				Rosca métrica	Tubo D.E. mm	A mm	B mm	E mm	W mm
	DN	Pulg.	Tamaño	mm						
11C16-8-4	6	1/4	-4	6,4	M16x1,5	8	48	26	29	19
11C16-10-4	6	1/4	-4	6,4	M18x1,5	10	48	26	29	22
11C16-10-5	8	5/16	-5	7,9	M18x1,5	10	59	36	31	22
11C16-12-5	8	5/16	-5	7,9	M20x1,5	12	59	36	31	24
11C16-10-6	10	3/8	-6	9,5	M18x1,5	10	59	37	36	22
11C16-12-6	10	3/8	-6	9,5	M20x1,5	12	58	35	37	24
11C16-16-8	12	1/2	-8	12,7	M24x1,5	16	61	37	45	30
11C16-20-10	16	5/8	-10	15,9	M30x2	20	65	40	48	36
11C16-20-12	19	3/4	-12	19,1	M30x2	20	79	54	58	36
11C16-25-12	19	3/4	-12	19,1	M36x2	25	80	54	59	46
11C16-30-16	25	1	-16	25,4	M42x2	30	104	75	75	50

Los terminales se entregan con junta tórica de Nitrilo (NBR) resistente al ozono como versión estándar. La temperatura de trabajo desde -40 °C hasta +105 °C. Disponibles a petición terminales con juntas tóricas especiales (Vitón o EPDM).

D2 Macho métrico recto 24° Serie pesada Rígido

ISO 12151-2-S-S – CES

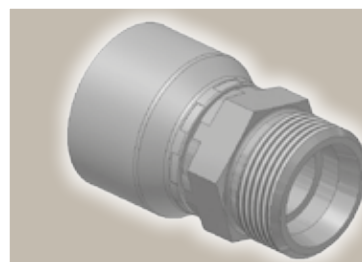
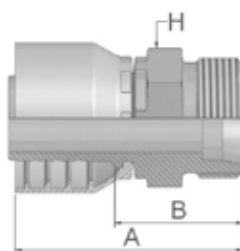

Referencia	D.I. de manguera				Rosca métrica	Tubo D.E. mm	A mm	B mm	H mm
	DN	Pulg.	Tamaño	mm					
1D216-8-4	6	1/4	-4	6,4	M16x1,5	8	47	24	17
1D216-10-4	6	1/4	-4	6,4	M18x1,5	10	48	26	19
1D216-12-5	8	5/16	-5	7,9	M20x1,5	12	48	26	22
1D216-12-6	10	3/8	-6	9,5	M20x1,5	12	49	26	22
1D216-16-8	12	1/2	-8	12,7	M24x1,5	16	52	29	24
1D216-20-10	16	5/8	-10	15,9	M30x2	20	57	32	30
1D216-20-12	19	3/4	-12	19,1	M30x2	20	61	35	30
1D216-25-12	19	3/4	-12	19,1	M36x2	25	64	38	36

Serie de terminales aprobados para tipos de manguera:

16 BCH1 | BCH2

EA Hembra giratoria BSP con junta tórica (Cono 60°)

BS 5200 – ISO 12151-6 – DKOR

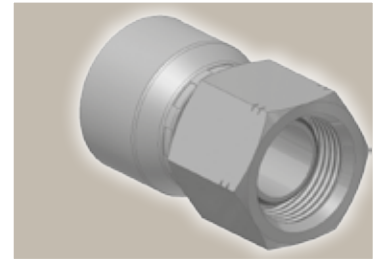
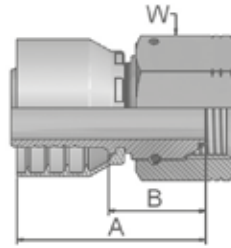

Referencia	D.I. de manguera				Rosca BSP	A mm	B mm	W mm
	DN	Pulg.	Tamaño	mm				
1EA16-4-4	6	1/4	-4	6,4	1/4x19	39	17	19
1EA16-6-4	6	1/4	-4	6,4	3/8x19	47	25	22
1EA16-6-6	10	3/8	-6	9,5	3/8x19	43	20	22
1EA16-8-6	10	3/8	-6	9,5	1/2x14	51	28	27
1EA16-8-8	12	1/2	-8	12,7	1/2x14	45	22	27
1EA16-10-10	16	5/8	-10	15,9	5/8x14	46	21	30
1EA16-12-12	19	3/4	-12	19,1	3/4x14	49	23	32
1EA16-16-16	25	1	-16	25,4	1x11	61	31	41

Los terminales se entregan con junta tórica de Nitrilo (NBR) resistente al ozono como versión estándar. La temperatura de trabajo desde -40 °C hasta +105 °C. Disponibles a petición terminales con juntas tóricas especiales (Vitón o EPDM).

EB Hembra giratoria BSP con junta tórica Codo 45° (Cono 60°)

BS 5200 – ISO 12151-6 – DKOR 45°

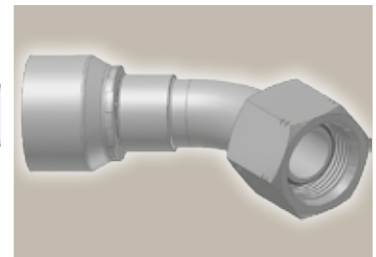
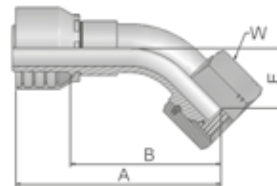

Referencia	D.I. de manguera				Rosca BSP	A mm	B mm	E mm	W mm
	DN	Pulg.	Tamaño	mm					
1EB16-4-4	6	1/4	-4	6,4	1/4x19	55	33	14	19
1EB16-6-4	6	1/4	-4	6,4	3/8x19	58	35	15	22
1EB16-6-6	10	3/8	-6	9,5	3/8x19	69	46	17	22
1EB16-8-6	10	3/8	-6	9,5	1/2x14	70	48	19	27
1EB16-8-8	12	1/2	-8	12,7	1/2x14	71	48	20	27
1EB16-10-10	16	5/8	-10	15,9	5/8x14	75	50	22	30
1EB16-12-12	19	3/4	-12	19,1	3/4x14	89	63	27	32
1EB16-16-16	25	1	-16	25,4	1x11	112	83	33	41

Los terminales se entregan con junta tórica de Nitrilo (NBR) resistente al ozono como versión estándar. La temperatura de trabajo desde -40 °C hasta +105 °C. Disponibles a petición terminales con juntas tóricas especiales (Vitón o EPDM).

Serie de terminales aprobados para tipos de manguera:

16 BCH1 | BCH2

EC Hembra giratoria BSP con junta tórica Codo 90° (Cono 60°)
BS 5200 – ISO 12151-6 – DKOR 90°

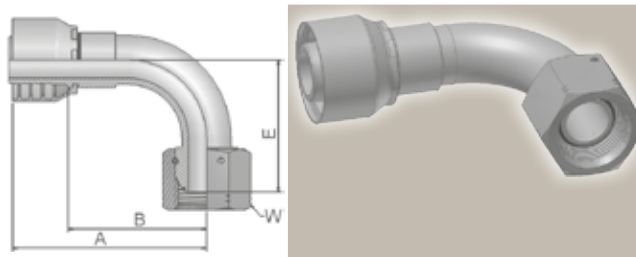

Referencia	D.I. de manguera				Rosca BSP	A mm	B mm	E mm	W mm
	DN	Pulg.	Tamaño	mm					
1EC16-4-4	6	1/4	-4	6,4	1/4x19	48	26	24	19
1EC16-6-4	6	1/4	-4	6,4	3/8x19	49	27	27	22
1EC16-6-6	10	3/8	-6	9,5	3/8x19	60	38	33	22
1EC16-8-6	10	3/8	-6	9,5	1/2x14	60	38	36	27
1EC16-8-8	12	1/2	-8	12,7	1/2x14	63	40	40	27
1EC16-10-10	16	5/8	-10	15,9	5/8x14	70	45	44	30
1EC16-12-12	19	3/4	-12	19,1	3/4x14	79	54	55	32
1EC16-16-16	25	1	-16	25,4	1x11	104	75	71	41

Los terminales se entregan con junta tórica de Nitrilo (NBR) resistente al ozono como versión estándar. La temperatura de trabajo desde -40 °C hasta +105 °C. Disponibles a petición terminales con juntas tóricas especiales (Vitón o EPDM).

D9 Macho cilíndrico BSP Rígido – Recto (Cono 60°)
BS5200 – AGR

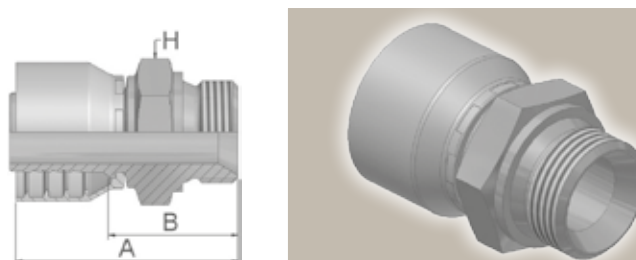

Referencia	D.I. de manguera				Rosca BSP	A mm	B mm	H mm
	DN	Pulg.	Tamaño	mm				
1D916-4-4	6	1/4	-4	6,4	1/4x19	49	27	19
1D916-6-4	6	1/4	-4	6,4	3/8x19	54	31	22
1D916-6-6	10	3/8	-6	9,5	3/8x19	54	31	22
1D916-8-6	10	3/8	-6	9,5	1/2x14	55	33	27
1D916-8-8	12	1/2	-8	12,7	1/2x14	57	33	27
1D916-10-10	16	5/8	-10	15,9	5/8x14	60	35	30
1D916-12-12	19	3/4	-12	19,1	3/4x14	62	36	32
1D916-16-16	25	1	-16	25,4	1x11	72	42	41

Serie de terminales aprobados para tipos de manguera:

16 BCH1 | BCH2

06/68 Hembra giratoria doble Asiento JIC 37° / SAE 45° Recta

ISO12151-5-SWS – DKJ

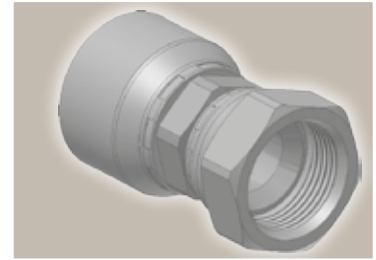
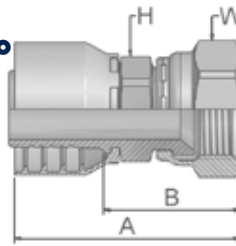

Referencia	D.I. de manguera				Rosca UNF	A mm	B mm	H mm	W mm
	DN	Pulg.	Tamaño	mm					
16816-4-4	6	1/4	-4	6,4	7/16x20	51	28	14	17
10616-6-4	6	1/4	-4	6,4	9/16x18	53	31	14	19
16816-5-5	8	5/16	-5	7,9	1/2x20	52	30	14	17
10616-6-6	10	3/8	-6	9,5	9/16x18	52	29	17	19
16816-8-6	10	3/8	-6	9,5	3/4x16	56	34	17	22
16816-8-8	12	1/2	-8	12,7	3/4x16	56	32	22	22
16816-10-8	12	1/2	-8	12,7	7/8x14	62	38	22	27
16816-10-10	16	5/8	-10	15,9	7/8x14	60	35	22	27
10616-12-10	16	5/8	-10	15,9	1 1/16x12	64	39	27	32
10616-12-12	19	3/4	-12	19,1	1 1/16x12	67	41	27	32
10616-16-12	19	3/4	-12	19,1	1 5/16x12	71	45	32	41
10616-16-16	25	1	-16	25,4	1 5/16x12	75	46	32	41

37/3V Hembra giratoria doble Asiento JIC 37° / SAE 45° Codo 45°

ISO 12151-5-SWE 45° – DKJ 45°

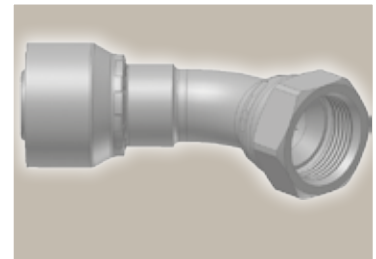
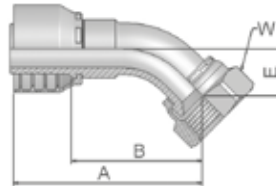

Referencia	D.I. de manguera				Rosca UNF	A mm	B mm	E mm	W mm
	DN	Pulg.	Tamaño	mm					
13V16-4-4	6	1/4	-4	6,4	7/16x20	51	29	10	17
13716-6-4	6	1/4	-4	6,4	9/16x18	53	31	11	19
13716-6-6	10	3/8	-6	9,5	9/16x18	60	37	11	19
13V16-8-6	10	3/8	-6	9,5	3/4x16	67	44	15	22
13V16-8-8	12	1/2	-8	12,7	3/4x16	61	37	15	22
13V16-10-8	12	1/2	-8	12,7	7/8x14	68	44	16	27
13V16-10-10	16	5/8	-10	15,9	7/8x14	69	44	16	27
13716-12-10	16	5/8	-10	15,9	1 1/16x12	74	49	21	32
13716-12-12	19	3/4	-12	19,1	1 1/16x12	83	58	22	32
13716-16-12	19	3/4	-12	19,1	1 5/16x12	84	58	24	41
13716-16-16	25	1	-16	25,4	1 5/16x12	99	70	24	41



Serie de terminales aprobados para tipos de manguera:

16 BCH1 | BCH2

39/3W Hembra giratoria doble Asiento JIC 37° / SAE 45° Codo 90°

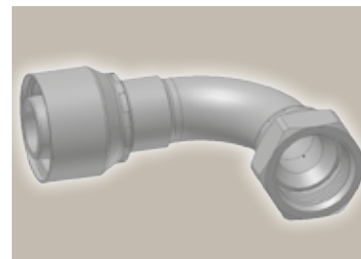
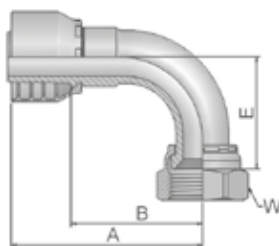
ISO 12151-5-SWES – DKJ 90°



Referencia	 D.I. de manguera				 Rosca UNF	A mm	B mm	E mm	 W mm
	DN	Pulg.	Tamaño	mm					
13W16-4-4	6	1/4	-4	6,4	7/16x20	46	24	21	17
13916-6-4	6	1/4	-4	6,4	9/16x18	48	25	23	19
13916-6-6	10	3/8	-6	9,5	9/16x18	50	28	23	19
13W16-8-6	10	3/8	-6	9,5	3/4x16	59	36	29	22
13W16-8-8	12	1/2	-8	12,7	3/4x16	55	31	29	22
13W16-10-8	12	1/2	-8	12,7	7/8x14	62	39	32	27
13W16-10-10	16	5/8	-10	15,9	7/8x14	69	44	33	27
13916-12-10	16	5/8	-10	15,9	1 1/16x12	74	49	48	32
13916-12-12	19	3/4	-12	19,1	1 1/16x12	80	54	48	32
13916-16-12	19	3/4	-12	19,1	1 5/16x12	80	54	56	41
13916-16-16	25	1	-16	25,4	1 5/16x12	98	68	56	41

Serie de terminales aprobados para tipos de manguera:

16 BCH1 | BCH2

JC Hembra giratoria ORFS Recta - Corta

ISO 12151-1 - SWSA
SAE J516 - ORFS

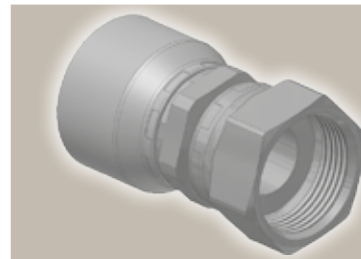
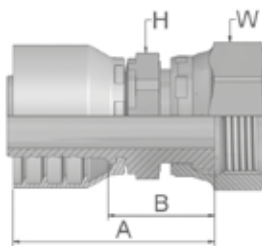

Referencia	D.I. de manguera				Rosca UNF	A mm	B mm	H mm	W mm
	DN	Pulg.	Tamaño	mm					
1JC16-4-4	6	1/4	-4	6,4	9/16x18	44	22	14	17
1JC16-6-6	10	3/8	-6	9,5	11/16x16	43	20	17	22
1JC16-8-8	12	1/2	-8	12,7	13/16x16	46	22	22	24
1JC16-10-10	16	5/8	-10	15,9	1x14	51	26	24	30
1JC16-12-12	19	3/4	-12	19,1	1 3/16x12	56	30	30	36
1JC16-16-16	25	1	-16	25,4	1 7/16x12	63	33	36	41

J7 Hembra giratoria ORFS Codo 45°

ISO 12151-1 - SWE 45°
SAE J516 - ORFS 45°

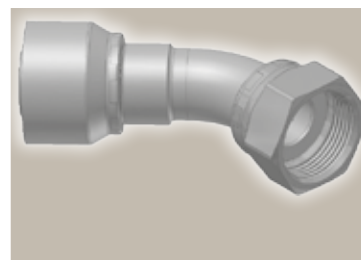
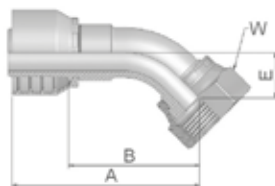

Referencia	D.I. de manguera				Rosca UNF	A mm	B mm	E mm	W mm
	DN	Pulg.	Tamaño	mm					
1J716-4-4	6	1/4	-4	6,4	9/16x18	53	31	10	17
1J716-6-6	10	3/8	-6	9,5	11/16x16	53	31	11	22
1J716-8-8	12	1/2	-8	12,7	13/16x16	61	38	15	24
1J716-10-10	16	5/8	-10	15,9	1x14	72	46	16	30
1J716-12-12	19	3/4	-12	19,1	1 3/16x12	83	57	21	36
1J716-16-16	25	1	-16	25,4	1 7/16x12	99	69	24	41

Serie de terminales aprobados para tipos de manguera:

16 BCH1 | BCH2

J9 Hembra giratoria ORFS Codo 90° – Corto

ISO 12151-1 – SWES
SAE J516 – ORFS 90°

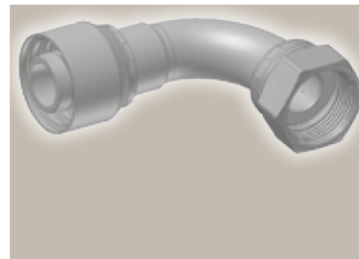
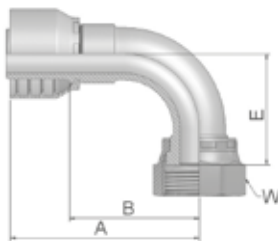

Referencia	D.I. de manguera				Rosca UNF	A mm	B mm	E mm	W mm
	DN	Pulg.	Tamaño	mm					
1J916-4-4	6	1/4	-4	6,4	9/16x18	50	28	21	17
1J916-6-6	10	3/8	-6	9,5	11/16x16	52	29	23	22
1J916-8-8	12	1/2	-8	12,7	13/16x16	55	31	29	24
1J916-10-10	16	5/8	-10	15,9	1x14	65	39	32	30
1J916-12-12	19	3/4	-12	19,1	1 3/16x12	80	54	48	36
1J916-16-16	25	1	-16	25,4	1 7/16x12	98	68	56	41

JM Macho ORFS

ISO 12151-1-S – SAE J516

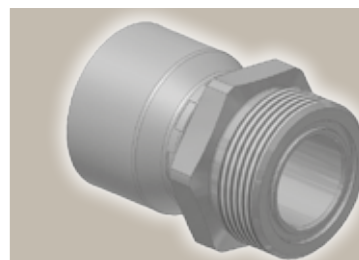
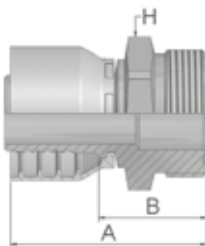

Referencia	D.I. de manguera				Rosca UNF	A mm	B mm	H mm
	DN	Pulg.	Tamaño	mm				
1JM16-4-4	6	1/4	-4	6,4	9/16x18	44	22	17
1JM16-6-6	10	3/8	-6	9,5	11/16x16	47	24	19
1JM16-8-8	12	1/2	-8	12,7	13/16x16	51	27	22
1JM16-10-10	16	5/8	-10	15,9	1x14	57	32	27
1JM16-12-12	19	3/4	-12	19,1	1 3/16x12	60	34	32
1JM16-16-16	25	1	-16	25,4	1 7/16x12	67	37	41

Serie de terminales aprobados para tipos de manguera:



16 BCH1 | BCH2

RACORES SERIE 26

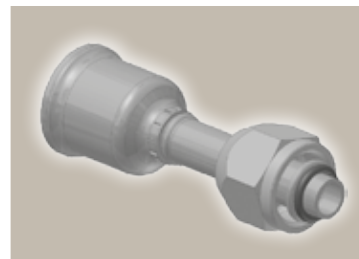
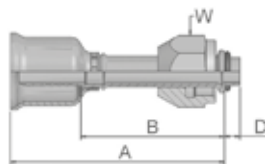

5S Hembra giratoria con tórica Piloto corto



Referencia	 D.I. de manguera			 Rosca UNF	A mm	B mm	D mm	 W Pulg.
	Pulg.	Tamaño	mm					
15S26-6-6	5/16	-6	8,0	5/8x18	66	44	4,7	3/4
15S26-8-8	13/32	-8	10,0	3/4x16	67	45	4,7	7/8
15S26-10-10	1/2	-10	12,5	7/8x14	71	47	4,7	1 1/16
15S26-10-12	5/8	-12	16,0	7/8x14	71	47	4,7	1 1/16

Serie de terminales aprobados para tipos de manguera:

26 285

5T Hembra giratoria con tórica Codo 90° Piloto corto

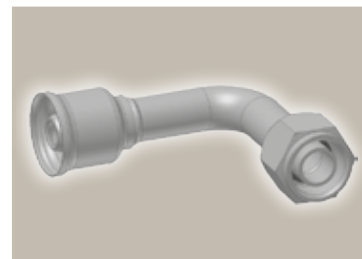
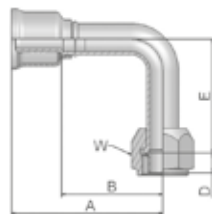

Referencia	D.I. de manguera			Rosca UNF	A mm	B mm	D mm	E mm	W Pulg.
	Pulg.	Tamaño	mm						
15T26-6-6	5/16	-6	8,0	5/8x18	56	34	4,7	36	3/4
15T26-8-8	13/32	-8	10,0	3/4x16	63	41	4,7	37	7/8
15T26-10-10	1/2	-10	12,5	7/8x14	73	49	4,7	44	1 1/16

Serie de terminales aprobados para tipos de manguera:

26 285

RACORES SERIE 48









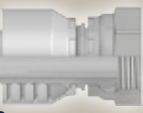

DIN – Métrica

Página Cd-1 – Cd-11

<p>CA</p> <p>Cd-1</p> <p>Hembra giratoria métrica 24° Serie ligera con junta tórica Recta ISO 12151-2-SWS-L – DKOL</p> 	<p>CE</p> <p>Cd-2</p> <p>Hembra giratoria métrica 24° Serie ligera con junta tórica Codo 45° ISO 12151-2-SWE 45°-L – DKOL 45°</p> 	<p>CF</p> <p>Cd-3</p> <p>Hembra giratoria métrica 24° Serie ligera con junta tórica Codo 90° ISO 12151-2-SWE-L – DKOL 90°</p> 	<p>DO</p> <p>Cd-4</p> <p>Macho métrico recto 24° Serie ligera – Recta ISO 12151-2-S-L – CEL</p> 
<p>C3</p> <p>Cd-5</p> <p>Hembra giratoria métrica Serie ligera Recta (Asiento ovalado) DKL</p> 	<p>C4</p> <p>Cd-5</p> <p>Hembra giratoria métrica Serie ligera Codo 45° (Asiento ovalado) DKL 45°</p> 	<p>C5</p> <p>Cd-6</p> <p>Hembra giratoria métrica Serie ligera Codo 90° (Asiento ovalado) DKL 90°</p> 	<p>C9</p> <p>Cd-7</p> <p>Hembra giratoria métrica 24° Serie pesada con junta tórica Recta ISO 12151-2-SWS-S – DKOS</p> 
<p>OC</p> <p>Cd-8</p> <p>Hembra giratoria métrica 24° Series pesada con junta tórica Codo 45° ISO 12151-2 – SWE 45°-S – DKOS 45°</p> 	<p>1C</p> <p>Cd-9</p> <p>Hembra giratoria métrica 24° Serie pesada con junta tórica Codo 90° ISO 12151-2-SWE-S – DKOS 90°</p> 	<p>D2</p> <p>Cd-10</p> <p>Macho métrico recto 24° Serie pesada Rígido ISO 12151-2-S-S – CES</p> 	<p>C6</p> <p>Cd-11</p> <p>Hembra giratoria métrica Serie pesada Recta (Asiento ovalado) DKS</p> 
<p>49</p> <p>Cd-11</p> <p>Banjo métrico – Recto DIN 7642</p> 			

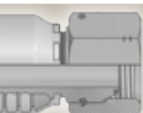

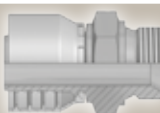

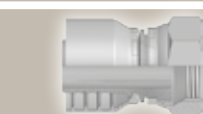

BSP

Página Cd-12 – Cd-20

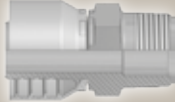
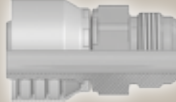
<p>92</p> <p>Cd-12</p> <p>Hembra giratoria BSP (Asiento 60°) BS5200-A – DKR</p> 	<p>B1</p> <p>Cd-13</p> <p>Hembra giratoria BSP cónica Codo 45° (Cono 60°) BS 5200-D – DKR 45°</p> 	<p>B2</p> <p>Cd-14</p> <p>Hembra giratoria BSP Cilíndrica Codo 90° (Asiento 60°) BS 5200-B – DKR 90°</p> 	<p>B4</p> <p>Cd-15</p> <p>Hembra giratoria BSP Cilíndrica – Codo 90° Tipo bloque (Cono 60°) BS 5200-E – DKR 90°</p> 
<p>EA</p> <p>Cd-16</p> <p>Hembra giratoria BSP con junta tórica (Cono 60°) BS 5200 – ISO 12151-6 – DKOR</p> 	<p>EB</p> <p>Cd-17</p> <p>Hembra giratoria BSP con junta tórica Codo 45° (Cono 60°) BS 5200 – ISO 12151-6 – DKOR 45°</p> 	<p>EC</p> <p>Cd-18</p> <p>Hembra giratoria BSP con junta tórica Codo 90° (Cono 60°) BS 5200 – ISO 12151-6 – DKOR 90°</p> 	<p>D9</p> <p>Cd-19</p> <p>Macho cilíndrico BSP Rígido – Recto (Cono 60°) BS5200 – AGR</p> 
<p>91</p> <p>Cd-20</p> <p>Macho cónico BSP Rígido – Recto BS5200 – AGR-K</p> 	<p>B5</p> <p>Cd-20</p> <p>Hembra giratoria BSP Cilíndrica Recta (Asiento plano)</p> 		

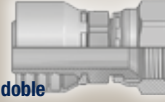
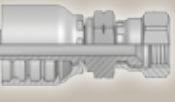





SAE

Página Cd-21 – Cd-28

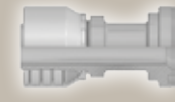
<p>01 Cd-21</p>  <p>Macho NPTF fijo Rígido – Recto SAE J476A / J516 – AGN</p>	<p>03 Cd-22</p>  <p>Macho JIC 37° Rígido – Recto ISO12151-5-S – AGJ</p>	<p>05 Cd-23</p>  <p>Macho recto SAE con junta tórica Rígido – Recto ISO 11926 – SAE J516</p>	<p>06/68 Cd-24</p>  <p>Hembra giratoria doble Asiento JIC 37° / SAE 45° Recta ISO12151-5-SWS – DKJ</p>
<p>08 Cd-25</p>  <p>Hembra giratoria SAE 45° Recta SAE J516</p>	<p>37/3V Cd-26</p>  <p>Hembra giratoria doble Asiento JIC 37° / SAE 45° Codo 45° ISO 12151-5-SWE 45° – DKJ 45°</p>	<p>39/3W Cd-27</p>  <p>Hembra giratoria doble Asiento JIC 37° / SAE 45° Codo 90° ISO 12151-5-SWES – DKJ 90°</p>	<p>41/3Y Cd-28</p>  <p>Hembra giratoria doble Asiento JIC 37° / SAE 45° Codo 90° (Largo) ISO 12151-5-SWEL – DKJ 90°L</p>

Bridas

Página Cd-29 – Cd-33

<p>15 Cd-29</p>  <p>Brida ISO 6162-1 Recta ISO 12151-3-S-L – SFL (21,0 MPa/ 3000 psi)</p>	<p>17 Cd-30</p>  <p>Brida ISO 6162-1 Codo 45° ISO 12151-3 – E45 – L – SFL 45° (35,0 MPa/ 5000 psi)</p>	<p>19 Cd-31</p>  <p>Brida ISO 6162-1 Codo 90° ISO 12151-3 – E – L – SFL 90° (21,0 MPa/ 3000 psi)</p>	<p>6A Cd-32</p>  <p>Brida ISO 6162-2 Recta ISO 12151-3-S-S – SFS (42,0 MPa/ 6000 psi)</p>
<p>6F Cd-32</p>  <p>Brida ISO 6162-2 Codo 45° ISO 12151-3 – E45-S – SFS 45° (42,0 MPa/ 6000 psi)</p>	<p>6N Cd-33</p>  <p>Brida ISO 6162-2 Codo 90° ISO 12151-3 – E-S – SFS 90° (42,0 MPa/ 6000 psi)</p>		

ORFS

Página Cd-34 – Cd-39

<p>JC Cd-34</p>  <p>Hembra giratoria ORFS Recta – Corta ISO 12151-1 – SWSA SAE J516 – ORFS</p>	<p>JS Cd-35</p>  <p>Hembra giratoria ORFS (Larga) ISO 12151-1-SWSB SAE J516 – ORFS</p>	<p>J7 Cd-36</p>  <p>Hembra giratoria ORFS Codo 45° ISO 12151-1 – SWE 45° SAE J516 – ORFS 45°</p>	<p>J9 Cd-37</p>  <p>Hembra giratoria ORFS Codo 90° – Corto ISO 12151-1 – SWES SAE J516 – ORFS 90°</p>
<p>J1 Cd-38</p>  <p>Hembra giratoria ORFS Codo 90° – Largo ISO 12151-1 – SWEL SAE J516 – ORFS 90° L</p>	<p>J5 Cd-38</p>  <p>Hembra giratoria ORFS Codo 90° – Medio ISO 12151-1 – SWEM – ORFS 90° M</p>	<p>JM Cd-39</p>  <p>Macho ORFS ISO 12151-1-S – SAE J516</p>	<p>JD Cd-39</p>  <p>Macho ORFS Pasatabiques con contratuerca Recto (con junta tórica) ISO 12151-1 – SAE J516</p>





JIS

Página Cd-40 – Cd-41

<p>FU Cd-40</p>  <p>Hembra giratoria BSP Cilíndrica Recta (Abocardado 30°) ISO 228-1 – JIS B8363 – GUI</p>	<p>GU Cd-40</p>  <p>Hembra giratoria BSP Cilíndrica (Codo 60°) ISO 228-1 – JIS B8363 – GUO</p>	<p>MU Cd-41</p>  <p>Hembra giratoria métrica Recta (Abocardado 30°) JIS B8363 – MU</p>	<p>MZ Cd-41</p>  <p>Hembra giratoria métrica Codo 90° (Abocardado 30°) JIS B8363</p>
---	---	--	---

Estándar Francés

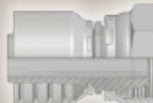
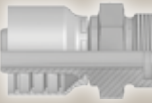
Página Cd-42 – Cd-44

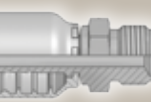
<p>FG Cd-42</p>  <p>Macho Gaz francés Rígido Recto (Cono 24°)</p>	<p>F2 Cd-42</p>  <p>Hembra giratoria francesa Serie Gaz Codo 90°</p>	<p>F4 Cd-43</p>  <p>Hembra giratoria francesa Serie Gaz Recta (Asiento ovalado)</p>	<p>F6 Cd-43</p>  <p>Macho francés métrico (Cono 24°)</p>
<p>F9 Cd-44</p>  <p>Hembras giratoria francesa métrica (Asiento ovalado)</p>	<p>FA Cd-44</p>  <p>Macho métrico para válvulas agrícolas</p>		

Limpieza de alta presión

Página Cd-45 – Cd-46

<p>CW Cd-45</p>  <p>Conexión Power Cleaner</p>	<p>NW Cd-45</p>  <p>Terminal de limpieza hembra giratoria métrica Kärcher Recta</p>	<p>PW Cd-46</p>  <p>Terminal de limpieza macho giratorio métrico rígido Kärcher – Recto</p>
---	--	---

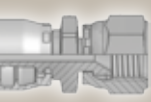
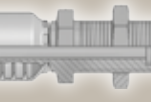

Otros

Página Cd-47 – Cd-48

<p>XU Cd-47</p>  <p>Hembra giratoria métrica Recta (Abocardado 30°) JIS B8363</p>	<p>DK Cd-47</p>  <p>Macho métrico L rígido Pasatabiques con contratuerca (Cono 24°)</p>	<p>DX Cd-48</p>  <p>Hembra giratoria métrica (M27x2) con tórica – Serie ligera</p>
--	--	--

UPTC (Universal push-to-connect)

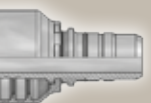
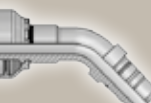
Página Cd-49 – Cd-50

<p>EN Cd-49</p>  <p>UPTC Recta</p>	<p>EU Cd-49</p>  <p>UPTC Codo 45°</p>	<p>ET Cd-50</p>  <p>UPTC Codo 90°</p>
---	--	---

CA Hembra giratoria métrica 24° Serie ligera con junta tórica Recta

ISO 12151-2-SWS-L – DKOL

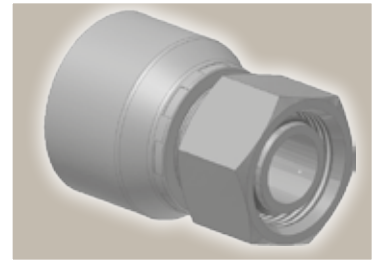
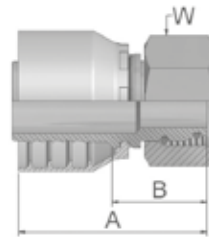

Referencia		D.I. de manguera				Rosca métrica	Tubo D.E.	A	B	W
Terminales Serie 46	Terminales Serie 48	DN	Pulg.	Tamaño	mm		mm	mm	mm	mm
1CA46-6-4	1CA48-6-4	6	1/4	-4	6,4	M12x1,5	6	46	22	14
1CA46-8-4	1CA48-8-4	6	1/4	-4	6,4	M14x1,5	8	46	22	17
1CA46-10-4	1CA48-10-4	6	1/4	-4	6,4	M16x1,5	10	46	22	19
1CA46-12-4	1CA48-12-4	6	1/4	-4	6,4	M18x1,5	12	46	22	22
1CA46-8-5	1CA48-8-5	8	5/16	-5	7,9	M14x1,5	8	50	26	17
1CA46-10-5	1CA48-10-5	8	5/16	-5	7,9	M16x1,5	10	46	22	19
1CA46-12-5	1CA48-12-5	8	5/16	-5	7,9	M18x1,5	12	46	22	22
1CA46-8-6	1CA48-8-6	10	3/8	-6	9,5	M14x1,5	8	49	26	17
1CA46-10-6	1CA48-10-6	10	3/8	-6	9,5	M16x1,5	10	46	23	19
1CA46-12-6	1CA48-12-6	10	3/8	-6	9,5	M18x1,5	12	46	23	22
1CA46-15-6	1CA48-15-6	10	3/8	-6	9,5	M22x1,5	15	47	24	27
1CA46-18-6	1CA48-18-6	10	3/8	-6	9,5	M26x1,5	18	50	28	32
1CA46-12-8	1CA48-12-8	12	1/2	-8	12,7	M18x1,5	12	50	26	22
1CA46-15-8	1CA48-15-8	12	1/2	-8	12,7	M22x1,5	15	50	26	27
1CA46-18-8	1CA48-18-8	12	1/2	-8	12,7	M26x1,5	18	49	25	32
1CA46-15-10	1CA48-15-10	16	5/8	-10	15,9	M22x1,5	15	54	29	27
1CA46-18-10	1CA48-18-10	16	5/8	-10	15,9	M26x1,5	18	50	25	32
1CA46-22-10	1CA48-22-10	16	5/8	-10	15,9	M30x2	22	58	33	36
1CA46-18-12	1CA48-18-12	19	3/4	-12	19,1	M26x1,5	18	51	25	32
1CA46-22-12	1CA48-22-12	19	3/4	-12	19,1	M30x2	22	56	30	36
1CA46-28-12	1CA48-28-12	19	3/4	-12	19,1	M36x2	28	61	35	41
1CA46-22-16	1CA48-22-16	25	1	-16	25,4	M30x2	22	60	30	36
1CA46-28-16	1CA48-28-16	25	1	-16	25,4	M36x2	28	63	33	41
1CA46-35-16	1CA48-35-16	25	1	-16	25,4	M45x2	35	63	33	50
	1CA48-28-20	31	1 1/4	-20	31,8	M36x2	28	81	34	41
1CA46-35-20		31	1 1/4	-20	31,8	M45x2	35	69	31	50
	1CA48-35-20	31	1 1/4	-20	31,8	M45x2	35	82	35	50
	1CA48-42-20	31	1 1/4	-20	31,8	M52x2	42	82	35	60
	1CA48-35-24	38	1 1/2	-24	38,1	M45x2	35	75	37	50
	1CA48-42-24	38	1 1/2	-24	38,1	M52x2	42	77	39	60

Los terminales se entregan con junta tórica de Nitrilo (NBR) resistente al ozono como versión estándar. La temperatura de trabajo desde -40 °C hasta +105 °C. Disponibles a petición terminales con juntas tóricas especiales (Vitón o EPDM).

Disponible también en acero inoxidable.

Serie de terminales aprobados para tipos de manguera, dependiendo del tamaño:

46	o	48	441	441RH	461LT	462	462ST	462TC	462ST	629PU	692PU Twin						
46	463	492	492ST	492TC	692	692Twin	692TC	BCH1									
48	301SN	301TC	304	387	387ST	387TC	421RH	421SN	426	436	441RH	462PU	462PU Twin	BCH2	HT2	...	
	471TC	477	477ST	477TC	477RH	487	487ST	487TC	493	787	787TC	787ST	797	797TC	797ST	811	881

CE Hembra giratoria métrica 24° Serie ligera con junta tórica Codo 45°

ISO 12151-2-SWE 45°-L – DKOL 45°

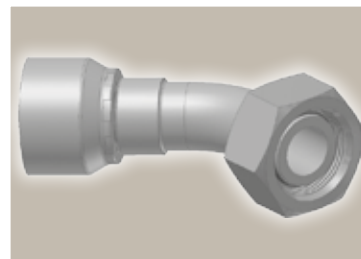
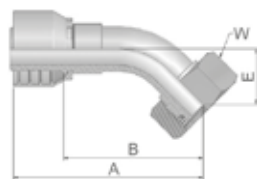

Referencia		D.I. de manguera				Rosca	Tubo	A	B	E	W
Terminales Serie 46	Terminales Serie 48	DN	Pulg.	Tamaño	mm	métrica	D.E. mm	mm	mm	mm	mm
1CE46-6-4		6	1/4	-4	6,4	M12x1,5	6	69	46	19	14
	1CE48-6-4	6	1/4	-4	6,4	M12x1,5	6	70	45	19	14
1CE46-8-4	1CE48-8-4	6	1/4	-4	6,4	M14x1,5	8	59	35	16	17
1CE46-10-4	1CE48-10-4	6	1/4	-4	6,4	M16x1,5	10	59	35	16	19
1CE46-12-4	1CE48-12-4	6	1/4	-4	6,4	M18x1,5	12	59	36	16	22
1CE46-8-5	1CE48-8-5	8	5/16	-5	7,9	M14x1,5	8	64	40	19	17
1CE46-10-5	1CE48-10-5	8	5/16	-5	7,9	M16x1,5	10	67	43	15	19
1CE46-12-5	1CE48-12-5	8	5/16	-5	7,9	M18x1,5	12	61	37	16	22
1CE46-10-6	1CE48-10-6	10	3/8	-6	9,5	M16x1,5	10	68	45	20	19
1CE46-12-6	1CE48-12-6	10	3/8	-6	9,5	M18x1,5	12	68	45	19	22
1CE46-15-6	1CE48-15-6	10	3/8	-6	9,5	M22x1,5	15	68	45	19	27
1CE46-12-8	1CE48-12-8	12	1/2	-8	12,7	M18x1,5	12	74	51	23	22
1CE46-15-8	1CE48-15-8	12	1/2	-8	12,7	M22x1,5	15	71	47	22	27
1CE46-18-8	1CE48-18-8	12	1/2	-8	12,7	M26x1,5	18	71	47	22	32
1CE46-15-10	1CE48-15-10	16	5/8	-10	15,9	M22x1,5	15	79	54	26	27
1CE46-18-10	1CE48-18-10	16	5/8	-10	15,9	M26x1,5	18	75	50	23	32
1CE46-18-12	1CE48-18-12	19	3/4	-12	19,1	M26x1,5	18	90	64	27	32
1CE46-22-12	1CE48-22-12	19	3/4	-12	19,1	M30x2	22	88	62	26	36
1CE46-28-12	1CE48-28-12	19	3/4	-12	19,1	M36x2	28	90	64	28	41
1CE46-22-16	1CE48-22-16	25	1	-16	25,4	M30x2	22	112	82	35	36
1CE46-28-16		25	1	-16	25,4	M36x 2	28	113	83	33	41
	1CE48-28-16	25	1	-16	25,4	M36x2	28	113	83	33	41
	1CE48-28-20	31	1 1/4	-20	31,8	M36x2	28	142	95	39	41
1CE46-35-20		31	1 1/4	-20	31,8	M45x2	35	130	92	32	50
	1CE48-35-20	31	1 1/4	-20	31,8	M45x2	35	141	94	37	50
	1CE48-42-24	38	1 1/2	-24	38,1	M52x2	42	155	117	49	60

Los terminales se entregan con junta tórica de Nitrilo (NBR) resistente al ozono como versión estándar. La temperatura de trabajo desde -40 °C hasta +105 °C. Disponibles a petición terminales con juntas tóricas especiales (Vitón o EPDM).

Disponible también en acero inoxidable.

Serie de terminales aprobados para tipos de manguera, dependiendo del tamaño:

46	o	48	441	441RH	461LT	462	462ST	462TC	462ST	629PU	692PU Twin						
46	463	492	492ST	492TC	692	692Twin	692TC	BCH1									
48	301SN	301TC	304	387	387ST	387TC	421RH	421SN	426	436	441RH	462PU	462PU Twin	BCH2	HT2	...	
	471TC	477	477ST	477TC	477RH	487	487ST	487TC	493	787	787TC	787ST	797	797TC	797ST	811	881

**CF Hembra giratoria métrica 24°
Serie ligera con junta tórica
Codo 90°**

ISO 12151-2-SWE-L – DKOL 90°

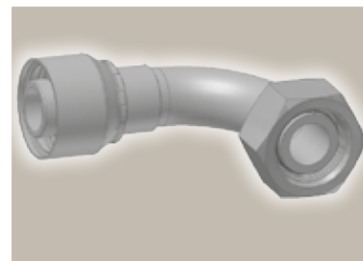
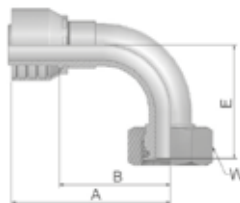

Referencia		D.I. de manguera				Rosca	Tubo	A	B	E	W
Terminales Serie 46	Terminales Serie 48	DN	Pulg.	Tamaño	mm	métrica	D.E. mm	mm	mm	mm	mm
1CF46-6-4	1CF48-6-4	6	1/4	-4	6,4	M12x1,5	6	57	33	33	14
1CF46-8-4	1CF48-8-4	6	1/4	-4	6,4	M14x1,5	8	51	28	29	17
1CF46-10-4	1CF48-10-4	6	1/4	-4	6,4	M16x1,5	10	52	28	29	19
1CF46-12-4	1CF48-12-4	6	1/4	-4	6,4	M18x1,5	12	53	26	29	22
1CF46-8-5	1CF48-8-5	8	5/16	-5	7,9	M14x1,5	8	62	38	34	17
1CF46-10-5	1CF48-10-5	8	5/16	-5	7,9	M16x1,5	10	61	37	29	19
1CF46-12-5	1CF48-12-5	8	5/16	-5	7,9	M18x1,5	12	61	37	30	22
1CF46-10-6	1CF48-10-6	10	3/8	-6	9,5	M16x1,5	10	60	37	37	19
1CF46-12-6	1CF48-12-6	10	3/8	-6	9,5	M18x1,5	12	58	35	36	22
1CF46-15-6	1CF48-15-6	10	3/8	-6	9,5	M22x1,5	15	58	35	36	27
1CF46-12-8	1CF48-12-8	12	1/2	-8	12,7	M18x1,5	12	63	39	45	22
1CF46-15-8	1CF48-15-8	12	1/2	-8	12,7	M22x1,5	15	61	37	43	27
1CF46-18-8	1CF48-18-8	12	1/2	-8	12,7	M26x1,5	18	65	41	43	32
1CF46-15-10	1CF48-15-10	16	5/8	-10	15,9	M22x1,5	15	67	42	50	27
1CF46-18-10	1CF48-18-10	16	5/8	-10	15,9	M26x1,5	18	66	41	45	32
1CF46-22-10	1CF48-22-10	16	5/8	-10	15,9	M30x2	22	71	46	47	36
1CF46-18-12	1CF48-18-12	19	3/4	-12	19,1	M26x1,5	18	80	54	56	32
1CF46-22-12	1CF48-22-12	19	3/4	-12	19,1	M30x2	22	80	54	55	36
1CF46-28-12	1CF48-28-12	19	3/4	-12	19,1	M36x2	28	80	54	57	41
1CF46-22-16	1CF48-22-16	25	1	-16	25,4	M30x2	22	102	72	74	36
1CF46-28-16	1CF48-28-16	25	1	-16	25,4	M36x2	28	101	72	71	41
	1CF48-22-20	31	1 1/4	-20	31,8	M30x2	22	130	83	81	36
1CF46-28-20		31	1 1/4	-20	31,8	M36x2	28	124	86	81	41
	1CF48-28-20	31	1 1/4	-20	31,8	M36x2	28	129	82	81	41
1CF46-35-20		31	1 1/4	-20	31,8	M45x2	35	124	86	79	50
	1CF48-35-20	31	1 1/4	-20	31,8	M45x2	35	130	83	79	50
	1CF48-35-24	38	1 1/2	-24	38,1	M45x2	35	139	101	99	50
	1CF48-42-24	38	1 1/2	-24	38,1	M52x2	42	139	101	101	60

Los terminales se entregan con junta tórica de Nitrilo (NBR) resistente al ozono como versión estándar. La temperatura de trabajo desde -40 °C hasta +105 °C. Disponibles a petición terminales con juntas tóricas especiales (Vitón o EPDM).

Disponible también en acero inoxidable.

Serie de terminales aprobados para tipos de manguera, dependiendo del tamaño:

46	o	48	441	441RH	461LT	462	462ST	462TC	462ST	629PU	692PU	Twin					
46	463	492	492ST	492TC	692	692Twin	692TC	BCH1									
48	301SN	301TC	304	387	387ST	387TC	421RH	421SN	426	436	441RH	462PU	462PU Twin	BCH2	HT2	...	
	471TC	477	477ST	477TC	477RH	487	487ST	487TC	493	787	787TC	787ST	797	797TC	797ST	811	881

D0 Macho métrico recto 24°
Serie ligera – Recta
ISO 12151-2-S-L – CEL

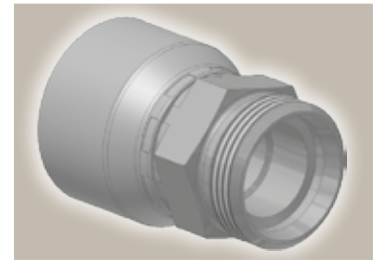
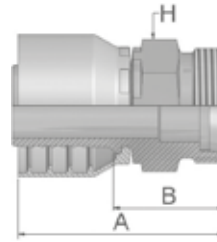

Referencia		D.I. de manguera				Rosca métrica	Tubo	A	B	H
Terminales Serie 46	Terminales Serie 48	DN	Pulg.	Tamaño	mm		D.E. mm	mm	mm	mm
1D046-6-4	1D048-6-4	6	1/4	-4	6,4	M12x1,5	6	44	20	12
1D046-8-4	1D048-8-4	6	1/4	-4	6,4	M14x1,5	8	46	22	14
1D046-10-4	1D048-10-4	6	1/4	-4	6,4	M16x1,5	10	48	24	17
1D046-12-4	1D048-12-4	6	1/4	-4	6,4	M18x1,5	12	48	24	19
1D046-8-5	1D048-8-5	8	5/16	-5	7,9	M14x1,5	8	44	20	14
1D046-10-5		8	5/16	-5	7,9	M16x1,5	10	47	24	17
	1D048-10-5	8	5/16	-5	7,9	M16x1,5	10	48	24	17
1D046-12-5	1D048-12-5	8	5/16	-5	7,9	M18x1,5	12	48	24	19
1D046-10-6	1D048-10-6	10	3/8	-6	9,5	M16x1,5	10	47	24	17
1D046-12-6	1D048-12-6	10	3/8	-6	9,5	M18x1,5	12	47	24	19
1D046-15-6	1D048-15-6	10	3/8	-6	9,5	M22x1,5	15	49	26	22
1D046-12-8		12	1/2	-8	12,7	M18x1,5	12	47	23	19
1D046-15-8	1D048-15-8	12	1/2	-8	12,7	M22x1,5	15	50	26	22
1D046-18-8	1D048-18-8	12	1/2	-8	12,7	M26x1,5	18	53	29	27
1D046-15-10	1D048-15-10	16	5/8	-10	15,9	M22x1,5	15	57	29	27
1D046-18-10	1D048-18-10	16	5/8	-10	15,9	M26x1,5	18	54	29	27
1D046-18-12	1D048-18-12	19	3/4	-12	19,1	M26x1,5	18	55	29	27
1D046-22-12	1D048-22-12	19	3/4	-12	19,1	M30x2	22	59	33	30
1D046-28-12	1D048-28-12	19	3/4	-12	19,1	M36x2	28	60	34	36
1D046-28-16	1D048-28-16	25	1	-16	25,4	M36x2	28	65	35	36
1D046-35-20		31	1 1/4	-20	31,8	M45x2	35	78	40	46
	1D048-35-20	31	1 1/4	-20	31,8	M45x2	35	85	38	46
	1D048-42-24	38	1 1/2	-24	38,1	M52x2	42	77	39	55

Disponible también en acero inoxidable.

Serie de terminales aprobados para tipos de manguera, dependiendo del tamaño:

46	o	48	441	441RH	461LT	462	462ST	462TC	462ST	629PU	692PU Twin						
46	463	492	492ST	492TC	692	692Twin	692TC	BCH1									
48	301SN	301TC	304	387	387ST	387TC	421RH	421SN	426	436	441RH	462PU	462PU Twin	BCH2	HT2	...	
	471TC	477	477ST	477TC	477RH	487	487ST	487TC	493	787	787TC	787ST	797	797TC	797ST	811	881

C3 Hembra giratoria métrica Serie ligera Recta (Asiento ovalado)

DKL

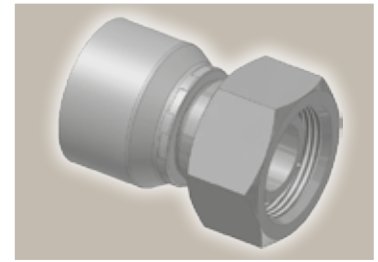
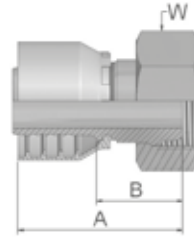

Referencia		D.I. de manguera				Rosca métrica	Tubo D.E.	A	B	W
Terminales Serie 46	Terminales Serie 48	DN	Pulg.	Tamaño	mm		mm	mm	mm	mm
	1C348-6-4	6	1/4	-4	6,4	M12x1,5	6	46	22	14
	1C348-8-4	6	1/4	-4	6,4	M14x1,5	8	45	21	17
	1C348-10-4	6	1/4	-4	6,4	M16x1,5	10	46	22	19
	1C348-10-5	8	5/16	-5	7,9	M16x1,5	10	46	22	19
	1C348-12-5	8	5/16	-5	7,9	M18x1,5	12	46	22	22
	1C348-10-6	10	3/8	-6	9,5	M16x1,5	10	46	24	19
	1C348-12-6	10	3/8	-6	9,5	M18x1,5	12	45	22	22
	1C348-15-8	12	1/2	-8	12,7	M22x1,5	15	48	24	27
	1C348-18-10	16	5/8	-10	15,9	M26x1,5	18	51	26	32
	1C348-22-12	19	3/4	-12	19,1	M30x2	22	56	30	36
	1C348-28-16	25	1	-16	25,4	M36x2	28	62	33	41

C4 Hembra giratoria métrica Serie ligera Codo 45° (Asiento ovalado)

DKL 45°

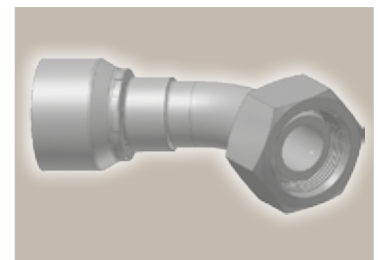
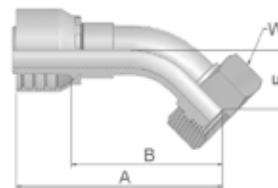

Referencia		D.I. de manguera				Rosca métrica	Tubo D.E.	A	B	E	W
Terminales Serie 46	Terminales Serie 48	DN	Pulg.	Tamaño	mm		mm	mm	mm	mm	mm
	1C448-8-4	6	1/4	-4	6,4	M14x1,5	8	56	33	14	17
	1C448-10-5	8	5/16	-5	7,9	M16x1,5	10	58	34	15	19
	1C448-12-6	10	3/8	-6	9,5	M18x1,5	12	67	44	18	22
	1C448-15-8	12	1/2	-8	12,7	M22x1,5	15	68	45	19	27

Disponible también en acero inoxidable.

Serie de terminales aprobados para tipos de manguera, dependiendo del tamaño:

46	o	48	441	441RH	461LT	462	462ST	462TC	462ST	629PU	692PU Twin						
46	463	492	492ST	492TC	692	692Twin	692TC	BCH1									
48	301SN	301TC	304	387	387ST	387TC	421RH	421SN	426	436	441RH	462PU	462PU Twin	BCH2	HT2	...	
	471TC	477	477ST	477TC	477RH	487	487ST	487TC	493	787	787TC	787ST	797	797TC	797ST	811	881

**C5 Hembra giratoria métrica
Serie ligera
Codo 90° (Asiento ovalado)**

DKL 90°

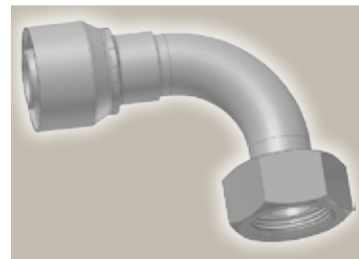
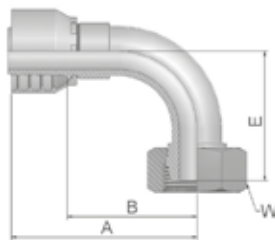

Referencia	D.I. de manguera				Rosca métrica	Tubo D.E. mm	A mm	B mm	E mm	W mm
	DN	Pulg.	Tamaño	mm						
1C548-6-4	6	1/4	-4	6,4	M12x1,5	6	49	26	29	14
1C548-8-4	6	1/4	-4	6,4	M14x1,5	8	48	25	26	17
1C548-10-5	8	5/16	-5	7,9	M16x1,5	10	61	37	33	19
1C548-10-6	10	3/8	-6	9,5	M16x1,5	10	58	35	35	19
1C548-12-6	10	3/8	-6	9,5	M18x1,5	12	58	35	34	22
1C548-15-8	12	1/2	-8	12,7	M22x1,5	15	64	41	39	27
1C548-18-10	16	5/8	-10	15,9	M26x1,5	18	66	41	43	32
1C548-22-12	19	3/4	-12	19,1	M30x2	22	80	54	50	36

Serie de terminales aprobados para tipos de manguera, dependiendo del tamaño:

Disponible también en acero inoxidable.

46	o	48	441	441RH	461LT	462	462ST	462TC	462ST	629PU	692PU Twin						
46	463	492	492ST	492TC	692	692Twin	692TC	BCH1									
48	301SN	301TC	304	387	387ST	387TC	421RH	421SN	426	436	441RH	462PU	462PU Twin	BCH2	HT2	...	
	471TC	477	477ST	477TC	477RH	487	487ST	487TC	493	787	787TC	787ST	797	797TC	797ST	811	881

C9 Hembra giratoria métrica 24° Serie pesada con junta tórica Recta

ISO 12151-2-SWS-S – DKOS

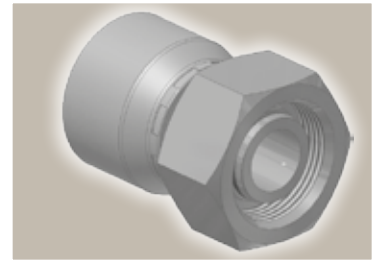
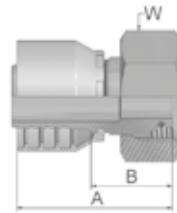

Referencia		D.I. de manguera				Rosca métrica	Tubo D.E.	A	B	W
Terminales Serie 46	Terminales Serie 48	DN	Pulg.	Tamaño	mm		mm	mm	mm	mm
1C946-6-4		6	1/4	-4	6,4	M14x1,5	6	48	26	17
	1C948-6-4	6	1/4	-4	6,4	M14x1,5	6	49	26	17
1C946-8-4	1C948-8-4	6	1/4	-4	6,4	M16x1,5	8	47	23	19
1C946-10-4	1C948-10-4	6	1/4	-4	6,4	M18x1,5	10	46	22	22
1C946-12-4	1C948-12-4	6	1/4	-4	6,4	M20x1,5	12	47	24	24
1C946-14-4	1C948-14-4	6	1/4	-4	6,4	M22x1,5	14	48	24	27
1C946-8-5	1C948-8-5	8	5/16	-5	7,9	M16x1,5	8	46	23	19
1C946-10-5	1C948-10-5	8	5/16	-5	7,9	M18x1,5	10	46	22	22
1C946-12-5	1C948-12-5	8	5/16	-5	7,9	M20x1,5	12	48	24	24
1C946-14-5	1C948-14-5	8	5/16	-5	7,9	M22x1,5	14	48	24	27
1C946-16-5	1C948-16-5	8	5/16	-5	7,9	M24x1,5	16	52	28	30
1C946-8-6	1C948-8-6	10	3/8	-6	9,5	M16x1,5	8	49	26	19
1C946-10-6	1C948-10-6	10	3/8	-6	9,5	M18x1,5	10	45	22	22
1C946-12-6	1C948-12-6	10	3/8	-6	9,5	M20x1,5	12	47	24	24
1C946-14-6	1C948-14-6	10	3/8	-6	9,5	M22x1,5	14	47	24	27
1C946-16-6	1C948-16-6	10	3/8	-6	9,5	M24x1,5	16	50	28	30
1C946-12-8	1C948-12-8	12	1/2	-8	12,7	M20x1,5	12	51	28	24
1C946-14-8	1C948-14-8	12	1/2	-8	12,7	M22x1,5	14	48	24	27
1C946-16-8	1C948-16-8	12	1/2	-8	12,7	M24x1,5	16	51	28	30
1C946-20-8	1C948-20-8	12	1/2	-8	12,7	M30x2	20	53	29	36
1C946-16-10	1C948-16-10	16	5/8	-10	15,9	M24x1,5	16	53	28	30
1C946-20-10	1C948-20-10	16	5/8	-10	15,9	M30x2	20	53	28	36
	1C948-12-12	19	3/4	-12	19,1	M20x1,5	12	53	28	24
	1C948-16-12	19	3/4	-12	19,1	M24x1,5	16	55	29	30
1C946-20-12	1C948-20-12	19	3/4	-12	19,1	M30x2	20	56	30	36
1C946-25-12	1C948-25-12	19	3/4	-12	19,1	M36x2	25	61	35	46
1C946-25-16	1C948-25-16	25	1	-16	25,4	M36x2	25	63	33	46
1C946-30-16	1C948-30-16	25	1	-16	25,4	M42x2	30	67	38	50
	1C948-25-20	31	1 1/4	-20	31,8	M36x2	25	81	34	46
1C946-38-20		31	1 1/4	-20	31,8	M52x2	38	74	36	60
	1C948-38-20	31	1 1/4	-20	31,8	M52x2	38	80	33	60

Los terminales se entregan con junta tórica de Nitrilo (NBR) resistente al ozono como versión estándar. La temperatura de trabajo desde -40 °C hasta +105 °C. Disponibles a petición terminales con juntas tóricas especiales (Vitón o EPDM).

Disponible también en acero inoxidable.

Serie de terminales aprobados para tipos de manguera, dependiendo del tamaño:

46	o	48	441	441RH	461LT	462	462ST	462TC	462ST	629PU	692PU	Twin					
46	463	492	492ST	492TC	692	692Twin	692TC	BCH1									
48	301SN	301TC	304	387	387ST	387TC	421RH	421SN	426	436	441RH	462PU	462PU Twin	BCH2	HT2	...	
	471TC	477	477ST	477TC	477RH	487	487ST	487TC	493	787	787TC	787ST	797	797TC	797ST	811	881

OC Hembra giratoria métrica 24° Series pesada con junta tórica Codo 45°

ISO 12151-2 – SWE 45°-S – DKOS 45°

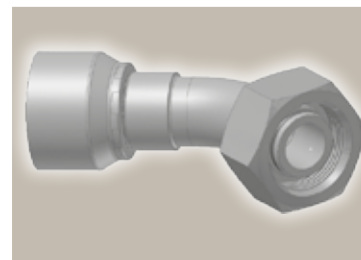
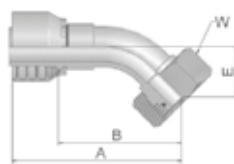

Referencia		D.I. de manguera				Rosca métrica	Tubo	A mm	B mm	E mm	W mm
Terminales Serie 46	Terminales Serie 48	DN	Pulg.	Tamaño	mm		D.E. mm				
10C46-6-4	10C48-6-4	6	1/4	-4	6,4	M14x1,5	6	61	38	16	17
10C46-8-4	10C48-8-4	6	1/4	-4	6,4	M16x1,5	8	59	35	16	19
10C46-10-4	10C48-10-4	6	1/4	-4	6,4	M18x1,5	10	59	36	16	22
10C46-12-4	10C48-12-4	6	1/4	-4	6,4	M20x1,5	12	71	48	17	24
10C46-10-5	10C48-10-5	8	5/16	-5	7,9	M18x1,5	10	62	38	17	22
10C46-12-5	10C48-12-5	8	5/16	-5	7,9	M20x1,5	12	70	47	17	24
10C46-10-6	10C48-10-6	10	3/8	-6	9,5	M18x1,5	10	70	47	19	22
10C46-12-6	10C48-12-6	10	3/8	-6	9,5	M20x1,5	12	69	46	20	24
10C46-14-6	10C48-14-6	10	3/8	-6	9,5	M22x1,5	14	69	46	20	27
10C46-14-8	10C48-14-8	12	1/2	-8	12,7	M22x1,5	14	69	46	21	27
10C46-16-8	10C48-16-8	12	1/2	-8	12,7	M24x1,5	16	72	49	23	30
10C46-16-10	10C48-16-10	16	5/8	-10	15,9	M24x1,5	16	77	52	24	30
10C46-20-10	10C48-20-10	16	5/8	-10	15,9	M30x2	20	76	51	25	36
10C46-20-12	10C48-20-12	19	3/4	-12	19,1	M30x2	20	90	64	28	36
10C46-25-12	10C48-25-12	19	3/4	-12	19,1	M36x2	25	91	65	29	46
	10C48-30-12	19	3/4	-12	19,1	M42x2	30	93	67	31	50
10C46-25-16		25	1	-16	25,4	M36x2	25	109	80	33	46
	10C48-25-16	25	1	-16	25,4	M36x2	30	109	80	33	46
10C46-30-16	10C48-30-16	25	1	-16	25,4	M42x2	30	115	86	36	50
10C46-38-20		31	1 1/4	-20	31,8	M52x2	38	136	98	38	60
	10C48-38-20	31	1 1/4	-20	31,8	M52x2	38	140	93	37	60
	10C48-38-24	38	1 1/2	-24	38,1	M52x2	38	155	117	49	60

Los terminales se entregan con junta tórica de Nitrilo (NBR) resistente al ozono como versión estándar. La temperatura de trabajo desde -40 °C hasta +105 °C. Disponibles a petición terminales con juntas tóricas especiales (Vitón o EPDM).

Disponible también en acero inoxidable.

Serie de terminales aprobados para tipos de manguera, dependiendo del tamaño:

46	o	48	441	441RH	461LT	462	462ST	462TC	462ST	629PU	692PU Twin						
46	463	492	492ST	492TC	692	692Twin	692TC	BCH1									
48	301SN	301TC	304	387	387ST	387TC	421RH	421SN	426	436	441RH	462PU	462PU Twin	BCH2	HT2	...	
	471TC	477	477ST	477TC	477RH	487	487ST	487TC	493	787	787TC	787ST	797	797TC	797ST	811	881

1C Hembra giratoria métrica 24° Serie pesada con junta tórica Codo 90°

ISO 12151-2-SWE-S – DKOS 90°

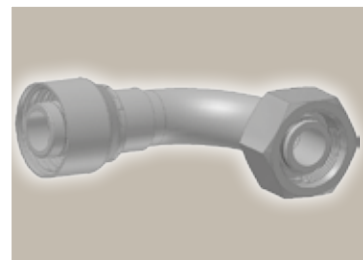
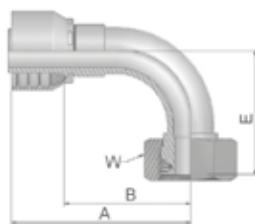

Referencia		D.I. de manguera				Rosca	Tubo	A	B	E	W
Terminales Serie 46	Terminales Serie 48	DN	Pulg.	Tamaño	mm	métrica	D.E. mm	mm	mm	mm	mm
11C46-6-4	11C48-6-4	6	1/4	-4	6,4	M14x1,5	6	62	39	32	17
11C46-8-4	11C48-8-4	6	1/4	-4	6,4	M16x1,5	8	50	26	29	19
11C46-10-4	11C48-10-4	6	1/4	-4	6,4	M18x1,5	10	50	26	29	22
11C46-12-4	11C48-12-4	6	1/4	-4	6,4	M20x1,5	12	60	38	30	24
11C46-10-5	11C48-10-5	8	5/16	-5	7,9	M18x1,5	10	60	36	31	22
11C46-12-5	11C48-12-5	8	5/16	-5	7,9	M20x1,5	12	60	36	32	24
11C46-10-6	11C48-10-6	10	3/8	-6	9,5	M18x1,5	10	59	37	36	22
11C46-12-6	11C48-12-6	10	3/8	-6	9,5	M20x1,5	12	58	35	37	24
11C46-14-6	11C48-14-6	10	3/8	-6	9,5	M22x1,5	14	58	35	37	27
	11C48-16-6	10	3/8	-6	9,5	M24x1,5	16	63	38	40	30
	11C48-12-8	12	1/2	-8	12,7	M20x1,5	12	63	39	44	24
11C46-14-8	11C48-14-8	12	1/2	-8	12,7	M22x1,5	14	62	38	42	27
11C46-16-8	11C48-16-8	12	1/2	-8	12,7	M24x1,5	16	61	37	45	30
11C46-20-8	11C48-20-8	12	1/2	-8	12,7	M30x2	20	61	37	46	36
11C46-16-10	11C48-16-10	16	5/8	-10	15,9	M24x1,5	16	66	41	48	30
11C46-20-10	11C48-20-10	16	5/8	-10	15,9	M30x2	20	65	40	48	36
11C46-25-10	11C48-25-10	16	5/8	-10	15,9	M36x2	25	76	51	52	46
11C46-20-12	11C48-20-12	19	3/4	-12	19,1	M30x2	20	79	54	58	36
11C46-25-12	11C48-25-12	19	3/4	-12	19,1	M36x2	25	80	54	59	46
	11C48-30-12	19	3/4	-12	19,1	M42x2	30	80	54	61	50
11C46-25-16	11C48-25-16	25	1	-16	25,4	M36x2	25	102	72	71	46
11C46-30-16	11C48-30-16	25	1	-16	25,4	M42x2	30	104	75	75	50
11C46-38-16	11C48-38-16	25	1	-16	25,4	M52x2	38	105	75	75	60
	11C48-30-20	31	1 1/4	-20	31,8	M42x2	30	130	83	86	50
11C46-38-20		31	1 1/4	-20	31,8	M52x2	38	124	86	80	60
	11C48-38-20	31	1 1/4	-20	31,8	M52x2	38	130	83	78	60
	11C48-38-24	38	1 1/2	-24	38,1	M52x2	38	139	101	101	60

Los terminales se entregan con junta tórica de Nitrilo (NBR) resistente al ozono como versión estándar. La temperatura de trabajo desde -40 °C hasta +105 °C. Disponibles a petición terminales con juntas tóricas especiales (Vitón o EPDM).

Disponible también en acero inoxidable.

Serie de terminales aprobados para tipos de manguera, dependiendo del tamaño:

46	o	48	441	441RH	461LT	462	462ST	462TC	462ST	629PU	692PU Twin						
46	463	492	492ST	492TC	692	692Twin	692TC	BCH1									
48	301SN	301TC	304	387	387ST	387TC	421RH	421SN	426	436	441RH	462PU	462PU Twin	BCH2	HT2	...	
	471TC	477	477ST	477TC	477RH	487	487ST	487TC	493	787	787TC	787ST	797	797TC	797ST	811	881

D2 Macho métrico recto 24° Serie pesada Rígido

ISO 12151-2-S-S – CES

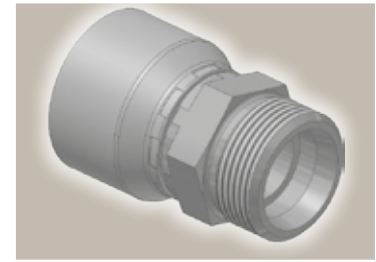
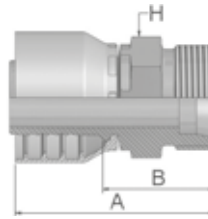

Referencia		D.I. de manguera				Rosca métrica	Tubo D.E.	A	B	H
Terminales Serie 46	Terminales Serie 48	DN	Pulg.	Tamaño	mm		mm	mm	mm	
1D246-6-4	1D248-6-4	6	1/4	-4	6,4	M14x1,5	6	48	24	14
1D246-8-4	1D248-8-4	6	1/4	-4	6,4	M16x1,5	8	48	24	17
1D246-10-4	1D248-10-4	6	1/4	-4	6,4	M18x1,5	10	50	26	19
1D246-12-4	1D248-12-4	6	1/4	-4	6,4	M20x1,5	12	48	26	22
1D246-8-5	1D248-8-5	8	5/16	-5	7,9	M16x1,5	8	48	24	17
1D246-10-5	1D248-10-5	8	5/16	-5	7,9	M18x1,5	10	50	26	19
1D246-12-5	1D248-12-5	8	5/16	-5	7,9	M20x1,5	12	50	26	22
1D246-14-5	1D248-14-5	8	5/16	-5	7,9	M22x1,5	14	51	28	22
	1D248-16-5	8	5/16	-5	7,9	M24x1,5	16	53	29	24
1D246-10-6	1D248-10-6	10	3/8	-6	9,5	M18x1,5	10	50	27	19
1D246-12-6	1D248-12-6	10	3/8	-6	9,5	M20x1,5	12	49	26	22
1D246-14-6	1D248-14-6	10	3/8	-6	9,5	M22x1,5	14	51	28	22
1D246-12-8	1D248-12-8	12	1/2	-8	12,7	M20x1,5	12	49	26	22
	1D248-14-8	12	1/2	-8	12,7	M22x1,5	14	52	28	22
1D246-16-8	1D248-16-8	12	1/2	-8	12,7	M24x1,5	16	52	29	24
	1D248-20-8	12	1/2	-8	12,7	M30x2	20	58	35	30
1D246-16-10	1D248-16-10	16	5/8	-10	15,9	M24x1,5	16	58	30	24
1D246-20-10	1D248-20-10	16	5/8	-10	15,9	M30x2	20	58	32	30
	1D248-16-12	19	3/4	-12	19,1	M24x1,5	16	56	31	27
1D246-20-12	1D248-20-12	19	3/4	-12	19,1	M30x2	20	61	35	30
1D246-25-12	1D248-25-12	19	3/4	-12	19,1	M36x2	25	64	38	36
1D246-25-16	1D248-25-16	25	1	-16	25,4	M36x2	25	68	39	36
1D246-30-16	1D248-30-16	25	1	-16	25,4	M42x2	30	71	42	46
1D246-38-20		31	1 1/4	-20	31,8	M52x2	38	84	46	55
	1D248-38-20	31	1 1/4	-20	31,8	M52x2	38	91	44	55
	1D248-38-24	38	1 1/2	-24	38,1	M52x2	38	84	46	55

Disponible también en acero inoxidable.

Serie de terminales aprobados para tipos de manguera, dependiendo del tamaño:

46	o	48	441	441RH	461LT	462	462ST	462TC	462ST	629PU	692PU Twin						
46	463	492	492ST	492TC	692	692Twin	692TC	BCH1									
48	301SN	301TC	304	387	387ST	387TC	421RH	421SN	426	436	441RH	462PU	462PU Twin	BCH2	HT2	...	
	471TC	477	477ST	477TC	477RH	487	487ST	487TC	493	787	787TC	787ST	797	797TC	797ST	811	881

C6 Hembra giratoria métrica Serie pesada Recta (Asiento ovalado)

DKS

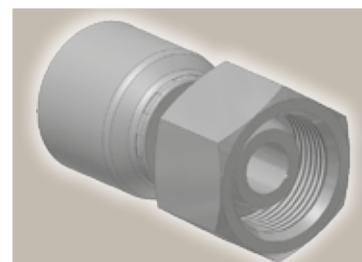
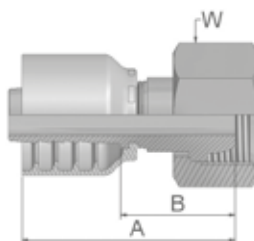

Referencia		D.I. de manguera				Rosca métrica	Tubo D.E.	A	B	H
Terminales Serie 46	Terminales Serie 48	DN	Pulg.	Tamaño	mm		mm	mm	mm	
	1C648-8-4	6	1/4	-4	6,4	M16x1,5	8	46	23	-
	1C648-12-6	10	3/8	-6	9,5	M20x1,5	12	47	25	-
	1C648-14-6	10	3/8	-6	9,5	M22x1,5	14	47	24	-
	1C648-16-8	12	1/2	-8	12,7	M24x1,5	16	51	28	-

49 Banjo métrico – Recto

DIN 7642

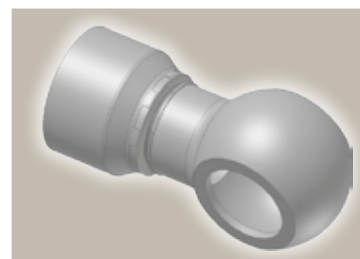
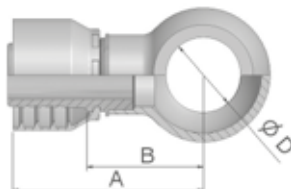

Referencia		D.I. de manguera				A	B	D
Terminales Serie 46	Terminales Serie 48	DN	Pulg.	Tamaño	mm	mm	mm	mm
14946-10-4	14948-10-4	6	1/4	-4	6,4	47	24	10
14946-12-4	14948-12-4	6	1/4	-4	6,4	50	26	12
14946-14-4	14948-14-4	6	1/4	-4	6,4	51	28	14
	14948-16-4	6	1/4	-4	6,4	55,6	29	16,1
14946-14-5	14948-14-5	8	5/16	-5	7,9	51	28	14
14946-16-5	14948-16-5	8	5/16	-5	7,9	53	30	16
14946-16-6	14948-16-6	10	3/8	-6	9,5	53	30	16
14946-17-6	14948-17-6	10	3/8	-6	9,5	53	30	17
14946-18-6	14948-18-6	10	3/8	-6	9,5	55	32	18
14946-22-6	14948-22-6	10	3/8	-6	9,5	58	35	22
14946-18-8	14948-18-8	12	1/2	-8	12,7	56	32	18
14946-22-8	14948-22-8	12	1/2	-8	12,7	59	35	22
14946-22-10	14948-22-10	16	5/8	-10	15,9	60	35	22
14946-26-12	14948-26-12	19	3/4	-12	19,1	66	40	26
14946-27-12	14948-27-12	19	3/4	-12	19,1	66	40	27

Vea sección Eb para seleccionar el tornillo y las juntas correspondientes.

Disponible también en acero inoxidable.

Serie de terminales aprobados para tipos de manguera, dependiendo del tamaño:

46	o	48	441	441RH	461LT	462	462ST	462TC	462ST	629PU	692PU Twin						
46	463	492	492ST	492TC	692	692Twin	692TC	BCH1									
48	301SN	301TC	304	387	387ST	387TC	421RH	421SN	426	436	441RH	462PU	462PU Twin	BCH2	HT2	...	
	471TC	477	477ST	477TC	477RH	487	487ST	487TC	493	787	787TC	787ST	797	797TC	797ST	811	881

92 Hembra giratoria BSP (Asiento 60°)

BS5200-A – DKR

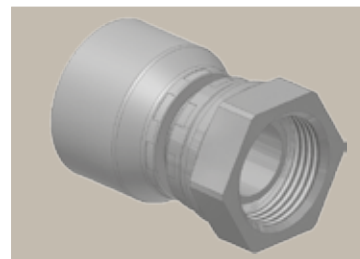
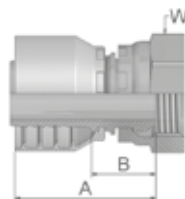

Referencia		D.I. de manguera				Rosca	A	B	W
Terminales Serie 46	Terminales Serie 48	DN	Pulg.	Tamaño	mm	BSP	mm	mm	mm
19246-2-4	19248-2-4	6	1/4	-4	6,4	1/8x28	41	17	14
19246-4-4		6	1/4	-4	6,4	1/4x19	46	19	19
	19248-4-4	6	1/4	-4	6,4	1/4x19	43	19	19
19246-6-4	19248-6-4	6	1/4	-4	6,4	3/8x19	44	20	22
19246-8-4	19248-8-4	6	1/4	-4	6,4	1/2x14	49	25	27
19246-4-5	19248-4-5	8	5/16	-5	7,9	1/4x19	43	19	19
19246-6-5	19248-6-5	8	5/16	-5	7,9	3/8x19	44	20	22
19246-4-6	19248-4-6	10	3/8	-6	9,5	1/4x19	43	20	19
19246-6-6	19248-6-6	10	3/8	-6	9,5	3/8x19	43	20	22
19246-8-6	19248-8-6	10	3/8	-6	9,5	1/2x14	45	22	27
19246-6-8	19248-6-8	12	1/2	-8	12,7	3/8x19	45	21	22
19246-8-8	19248-8-8	12	1/2	-8	12,7	1/2x14	45	22	27
19246-10-8	19248-10-8	12	1/2	-8	12,7	5/8x14	44	20	30
19246-12-8	19248-12-8	12	1/2	-8	12,7	3/4x14	47	23	32
19246-8-10	19248-8-10	16	5/8	-10	15,9	1/2x14	48	22	27
19246-10-10	19248-10-10	16	5/8	-10	15,9	5/8x14	45	20	30
19246-12-10	19248-12-10	16	5/8	-10	15,9	3/4x14	47	22	32
19246-8-12	19248-8-12	19	3/4	-12	19,1	1/2x14	49	23	27
19246-10-12	19248-10-12	19	3/4	-12	19,1	5/8x14	47	22	30
19246-12-12	19248-12-12	19	3/4	-12	19,1	3/4x14	49	23	32
19246-16-12	19248-16-12	19	3/4	-12	19,1	1x11	51	25	41
19246-16-16	19248-16-16	25	1	-16	25,4	1x11	55	25	41
19246-20-16		25	1	-16	25,4	1 1/4x11	61	31	50
	19248-20-16	25	1	-16	25,4	1 1/4x11	63	31	50
19246-20-20		31	1 1/4	-20	31,8	1 1/4x11	68	31	50
	19248-20-20	31	1 1/4	-20	31,8	1 1/4x11	79	32	50
	19248-24-24	38	1 1/2	-24	38,1	1 1/2x11	71	33	60
	19248-32-32	51	2	-32	50,8	2x11	84	35	70

Serie de terminales aprobados para **tipos de manguera**, dependiendo del tamaño:

Disponible también en acero inoxidable.

46	o	48	441	441RH	461LT	462	462ST	462TC	462ST	629PU	692PU Twin						
46	463	492	492ST	492TC	692	692Twin	692TC	BCH1									
48	301SN	301TC	304	387	387ST	387TC	421RH	421SN	426	436	441RH	462PU	462PU Twin	BCH2	HT2	...	
	471TC	477	477ST	477TC	477RH	487	487ST	487TC	493	787	787TC	787ST	797	797TC	797ST	811	881

B1 Hembra giratoria BSP cónica Codo 45° (Cono 60°)

BS 5200-D – DKR 45°

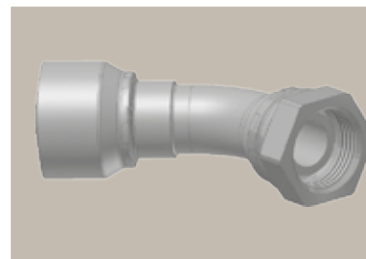
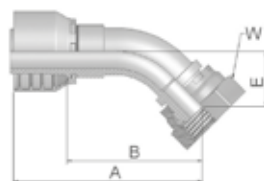

Referencia		D.I. de manguera				Rosca	A	B	E	W
Terminales Serie 46	Terminales Serie 48	DN	Pulg.	Tamaño	mm	BSP	mm	mm	mm	mm
1B146-4-4		6	1/4	-4	6,4	1/4x19	59	35	16	19
	1B148-4-4	6	1/4	-4	6,4	1/4x19	58	35	16	19
1B146-6-4	1B148-6-4	6	1/4	-4	6,4	3/8x19	59	35	14	22
1B146-6-5	1B148-6-5	8	5/16	-5	7,9	3/8x19	60	36	15	22
1B146-6-6	1B148-6-6	10	3/8	-6	9,5	3/8x19	69	46	17	22
1B146-8-6	1B148-8-6	10	3/8	-6	9,5	1/2x14	63	40	17	27
1B146-6-8	1B148-6-8	12	1/2	-8	12,7	3/8x19	72	49	21	22
1B146-8-8	1B148-8-8	12	1/2	-8	12,7	1/2x14	72	48	20	27
1B146-10-8	1B148-10-8	12	1/2	-8	12,7	5/8x14	69	46	19	30
1B146-10-10	1B148-10-10	16	5/8	-10	15,9	5/8x14	77	52	22	30
1B146-12-10	1B148-12-10	16	5/8	-10	15,9	3/4x14	74	49	20	32
1B146-12-12	1B148-12-12	19	3/4	-12	19,1	3/4x14	87	61	25	32
1B146-16-12	1B148-16-12	19	3/4	-12	19,1	1x11	88	62	26	41
1B146-16-16	1B148-16-16	25	1	-16	25,4	1x11	107	78	33	41
1B146-20-20		31	1 1/4	-20	31,8	1 1/4x11	136	98	38	50
	1B148-20-20	31	1 1/4	-20	31,8	1 1/4x11	141	94	38	50
	1B148-24-24	38	1 1/2	-24	38,1	1 1/2x11	160	122	52	55
	1B148-32-32	51	2	-32	50,8	2x11	210	161	66	70

Serie de terminales aprobados para tipos de manguera, dependiendo del tamaño:

Disponible también en acero inoxidable.

46	o	48	441	441RH	461LT	462	462ST	462TC	462ST	629PU	692PU Twin						
46	463	492	492ST	492TC	692	692Twin	692TC	BCH1									
48	301SN	301TC	304	387	387ST	387TC	421RH	421SN	426	436	441RH	462PU	462PU Twin	BCH2	HT2	...	
	471TC	477	477ST	477TC	477RH	487	487ST	487TC	493	787	787TC	787ST	797	797TC	797ST	811	881

**B2 Hembra giratoria BSP
Cilíndrica
Codo 90° (Asiento 60°)**
BS 5200-B – DKR 90°

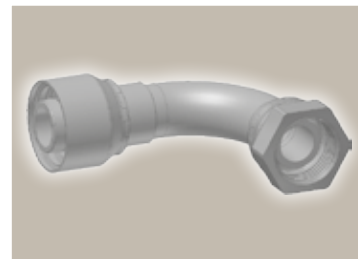
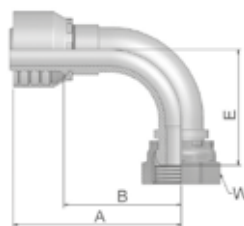

Referencia		D.I. de manguera				Rosca	A	B	E	W
Terminales Serie 46	Terminales Serie 48	DN	Pulg.	Tamaño	mm	BSP	mm	mm	mm	mm
1B246-2-4	1B248-2-4	6	1/4	-4	6,4	1/8x28	50	26	30	14
1B246-4-4	1B248-4-4	6	1/4	-4	6,4	1/4x19	50	26	28	19
1B246-6-4		6	1/4	-4	6,4	3/8x19	51	27	28	22
	1B248-6-4	6	1/4	-4	6,4	3/8x19	51	27	27	22
1B246-8-4	1B248-8-4	6	1/4	-4	6,4	1/2x14	51	27	29	27
1B246-6-5	1B248-6-5	8	5/16	-5	7,9	3/8x19	52	28	28	22
1B246-6-6	1B248-6-6	10	3/8	-6	9,5	3/8x19	61	38	33	22
1B246-8-6	1B248-8-6	10	3/8	-6	9,5	1/2x14	60	38	36	27
1B246-6-8	1B248-6-8	12	1/2	-8	12,7	3/8x19	63	40	41	22
1B246-8-8	1B248-8-8	12	1/2	-8	12,7	1/2x14	63	40	41	27
1B246-10-8	1B248-10-8	12	1/2	-8	12,7	5/8x14	67	43	38	30
1B246-10-10	1B248-10-10	16	5/8	-10	15,9	5/8x14	70	45	44	30
1B246-12-10	1B248-12-10	16	5/8	-10	15,9	3/4x14	70	45	42	32
1B246-12-12	1B248-12-12	19	3/4	-12	19,1	3/4x14	80	54	53	32
1B246-16-12	1B248-16-12	19	3/4	-12	19,1	1x11	80	54	54	41
1B246-16-16	1B248-16-16	25	1	-16	25,4	1x11	104	75	69	41
1B246-20-20		31	1 1/4	-20	31,8	1 1/4x11	124	86	80	50
	1B248-20-20	31	1 1/4	-20	31,8	1 1/4x11	129	82	80	50
	1B248-24-24	38	1 1/2	-24	38,1	1 1/2x11	140	102	103	55
	1B248-32-32	51	2	-32	50,8	2x11	185	137	134	70

Disponible también en acero inoxidable.

Serie de terminales aprobados para tipos de manguera, dependiendo del tamaño:

46	o	48	441	441RH	461LT	462	462ST	462TC	462ST	629PU	692PU Twin						
46	463	492	492ST	492TC	692	692Twin	692TC	BCH1									
48	301SN	301TC	304	387	387ST	387TC	421RH	421SN	426	436	441RH	462PU	462PU Twin	BCH2	HT2	...	
	471TC	477	477ST	477TC	477RH	487	487ST	487TC	493	787	787TC	787ST	797	797TC	797ST	811	881

B4 Hembra giratoria BSP Cilíndrica – Codo 90° Tipo bloque (Cono 60°)

BS 5200-E – DKR 90°

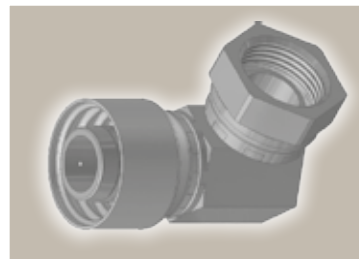
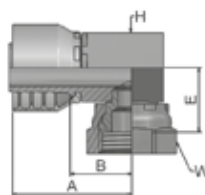

Referencia		D.I. de manguera				Rosca	A	B	E	H	W
Terminales Serie 46	Terminales Serie 48	DN	Pulg.	Tamaño	mm	BSP	mm	mm	mm	mm	mm
1B446-4-4	1B448-4-4	6	1/4	-4	6,4	1/4x19	58	34	22	17	19
1B446-6-4	1B448-6-4	6	1/4	-4	6,4	3/8x19	43	20	22	17	22
1B446-6-6	1B448-6-6	10	3/8	-6	9,5	3/8x19	68	45	23	19	22
1B446-8-6	1B448-8-6	10	3/8	-6	9,5	1/2x14	67	44	27	22	27
1B446-8-8	1B448-8-8	12	1/2	-8	12,7	1/2x14	67	43	27	22	27
1B446-10-10	1B448-10-10	16	5/8	-10	15,9	5/8x14	69	44	27	27	30
1B446-12-12	1B448-12-12	19	3/4	-12	19,1	3/4x14	72	47	33	32	32
1B446-16-16	1B448-16-16	25	1	-16	25,4	1x11	82	52	34	36	41

Versión corta disponible a petición (para prensar sólo en máquina universal)

Serie de terminales aprobados para tipos de manguera, dependiendo del tamaño:

Disponible también en acero inoxidable.

46	o	48	441	441RH	461LT	462	462ST	462TC	462ST	629PU	692PU Twin						
46	463	492	492ST	492TC	692	692Twin	692TC	BCH1									
48	301SN	301TC	304	387	387ST	387TC	421RH	421SN	426	436	441RH	462PU	462PU Twin	BCH2	HT2	...	
	471TC	477	477ST	477TC	477RH	487	487ST	487TC	493	787	787TC	787ST	797	797TC	797ST	811	881

**EA Hembra giratoria BSP
con junta tórica (Cono 60°)**
BS 5200 – ISO 12151-6 – DKOR

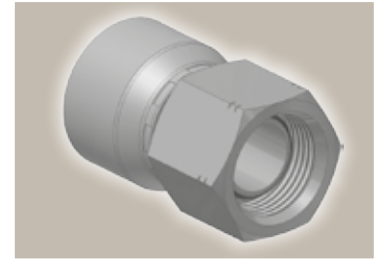
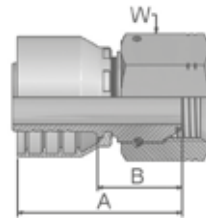

Referencia		D.I. de manguera				Rosca	A	B	W
Terminales Serie 46	Terminales Serie 48	DN	Pulg.	Tamaño	mm	BSP	mm	mm	mm
1EA46-4-4	1EA48-4-4	6	1/4	-4	6,4	1/4x19	40	17	19
1EA46-6-4	1EA48-6-4	6	1/4	-4	6,4	3/8x19	49	26	22
	1EA48-6-5	8	5/16	-5	7,9	3/8x19	50	25	22
	1EA48-4-6	10	3/8	-6	9,5	1/4x19	44	21	19
1EA46-6-6	1EA48-6-6	10	3/8	-6	9,5	3/8x19	43	20	22
1EA46-8-6	1EA48-8-6	10	3/8	-6	9,5	1/2x14	51	28	27
	1EA48-6-8	12	1/2	-8	12,7	3/8x19	46	22	22
1EA46-8-8	1EA48-8-8	12	1/2	-8	12,7	1/2x14	45	22	27
	1EA48-10-8	12	1/2	-8	12,7	5/8x14	43	20	30
1EA46-10-10	1EA48-10-10	16	5/8	-10	15,9	5/8x14	46	21	30
1EA46-12-10	1EA48-12-10	16	5/8	-10	15,9	3/4x14	54	29	32
1EA46-12-12	1EA48-12-12	19	3/4	-12	19,1	3/4x14	49	23	32
1EA46-16-12	1EA48-16-12	19	3/4	-12	19,1	1x11	61	35	41
1EA46-16-16	1EA48-16-16	25	1	-16	25,4	1x11	61	31	41
	1EA48-20-20	31	1 1/4	-20	31,8	1 1/4x11	78	31	50
	1EA48-24-24	38	1 1/2	-24	38,1	1 1/2x11	72	34	55

Los terminales se entregan con junta tórica de Nitrilo (NBR) resistente al ozono como versión estándar. La temperatura de trabajo desde -40 °C hasta +105 °C. Disponibles a petición terminales con juntas tóricas especiales (Vitón o EPDM).

Disponible también en acero inoxidable.

Serie de terminales aprobados para tipos de manguera, dependiendo del tamaño:

46	o	48	441	441RH	461LT	462	462ST	462TC	462ST	629PU	692PU Twin						
46	463	492	492ST	492TC	692	692Twin	692TC	BCH1									
48	301SN	301TC	304	387	387ST	387TC	421RH	421SN	426	436	441RH	462PU	462PU Twin	BCH2	HT2	...	
	471TC	477	477ST	477TC	477RH	487	487ST	487TC	493	787	787TC	787ST	797	797TC	797ST	811	881

**EB Hembra giratoria BSP
con junta tórica
Codo 45° (Cono 60°)**

BS 5200 – ISO 12151-6 – DKOR 45°

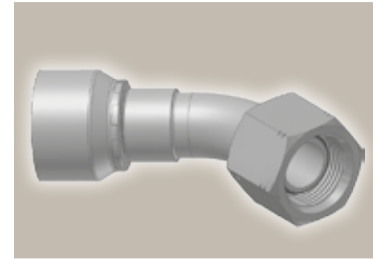
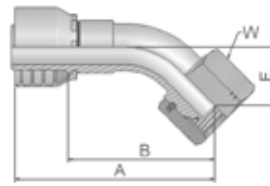

Referencia		D.I. de manguera				Rosca	A	B	E	W
Terminales Serie 46	Terminales Serie 48	DN	Pulg.	Tamaño	mm	BSP	mm	mm	mm	mm
1EB46-4-4		6	1/4	-4	6,4	1/4x19	59	36	14	19
	1EB48-4-4	6	1/4	-4	6,4	1/4x19	57	34	14	19
1EB46-6-6	1EB48-6-6	10	3/8	-6	9,5	3/8x19	69	46	17	22
1EB46-8-8	1EB48-8-8	12	1/2	-8	12,7	1/2x14	71	48	20	27
1EB46-12-10	1EB48-12-10	16	5/8	-10	15,9	3/4x14	78	52	21	32
1EB46-12-12	1EB48-12-12	19	3/4	-12	19,1	3/4x14	89	63	27	32
1EB46-16-16	1EB48-16-16	25	1	-16	25,4	1x11	112	82	33	41
	1EB48-20-20	31	1 1/4	-20	31,8	1 1/4x11	138	91	35	50
	1EB48-24-24	38	1 1/2	-24	38,1	1 1/2x11	157	119	50	55

Los terminales se entregan con junta tórica de Nitrilo (NBR) resistente al ozono como versión estándar. La temperatura de trabajo desde -40 °C hasta +105 °C. Disponibles a petición terminales con juntas tóricas especiales (Vitón o EPDM).

Serie de terminales aprobados para tipos de manguera, dependiendo del tamaño:

Disponible también en acero inoxidable.

46	o	48	441	441RH	461LT	462	462ST	462TC	462ST	629PU	692PU Twin						
46	463	492	492ST	492TC	692	692Twin	692TC	BCH1									
48	301SN	301TC	304	387	387ST	387TC	421RH	421SN	426	436	441RH	462PU	462PU Twin	BCH2	HT2	...	
	471TC	477	477ST	477TC	477RH	487	487ST	487TC	493	787	787TC	787ST	797	797TC	797ST	811	881

EC Hembra giratoria BSP con junta tórica Codo 90° (Cono 60°)

BS 5200 – ISO 12151-6 – DKOR 90°

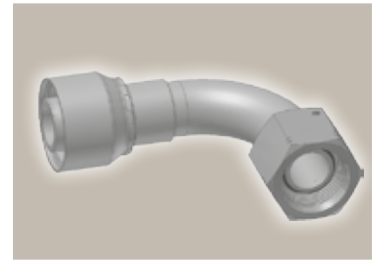
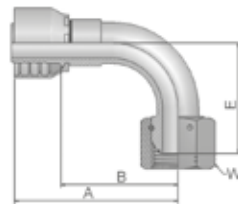

Referencia		D.I. de manguera				Rosca	A	B	E	W
		DN	Pulg.	Tamaño	mm	BSP	mm	mm	mm	mm
1EC46-4-4	1EC48-4-4	6	1/4	-4	6,4	1/4x19	50	27	24	19
1EC46-6-4	1EC48-6-4	6	1/4	-4	6,4	3/8x19	51	28	27	22
1EC46-6-6	1EC48-6-6	10	3/8	-6	9,5	3/8x19	60	38	33	22
1EC46-8-6	1EC48-8-6	10	3/8	-6	9,5	1/2x14	60	38	36	27
	1EC48-6-8	12	1/2	-8	12,7	3/8x19	63	39	41	22
1EC46-8-8	1EC48-8-8	12	1/2	-8	12,7	1/2x14	63	40	40	27
1EC46-10-8	1EC48-10-8	12	1/2	-8	12,7	5/8x14	63	40	39	30
1EC46-10-10	1EC48-10-10	16	5/8	-10	15,9	5/8x14	70	45	44	30
1EC46-12-10		16	5/8	-10	15,9	3/4x14	70	45	42	32
	1EC48-12-10	16	5/8	-10	15,9	5/8x14	70	45	42	32
1EC46-12-12	1EC48-12-12	19	3/4	-12	19,1	3/4x14	79	54	55	32
1EC46-16-12	1EC48-16-12	19	3/4	-12	19,1	1x11	80	54	59	41
1EC46-16-16	1EC48-16-16	25	1	-16	25,4	1x11	105	75	71	41
	1EC48-20-20	31	1 1/4	-20	31,8	1 1/4x11	129	82	75	50
	1EC48-24-24	38	1 1/2	-24	38,1	1 1/2x11	140	102	103	55
	1EC48-32-32	51	2	-32	50,8	2x11	185	137	132	70

Los terminales se entregan con junta tórica de Nitrilo (NBR) resistente al ozono como versión estándar. La temperatura de trabajo desde -40 °C hasta +105 °C. Disponibles a petición terminales con juntas tóricas especiales (Vitón o EPDM).

Disponible también en acero inoxidable.

Serie de terminales aprobados para tipos de manguera, dependiendo del tamaño:

46	o	48	441	441RH	461LT	462	462ST	462TC	462ST	629PU	692PU Twin						
46	463	492	492ST	492TC	692	692Twin	692TC	BCH1									
48	301SN	301TC	304	387	387ST	387TC	421RH	421SN	426	436	441RH	462PU	462PU Twin	BCH2	HT2	...	
	471TC	477	477ST	477TC	477RH	487	487ST	487TC	493	787	787TC	787ST	797	797TC	797ST	811	881

D9 Macho cilíndrico BSP Rígido – Recto (Cono 60°)

BS5200 – AGR

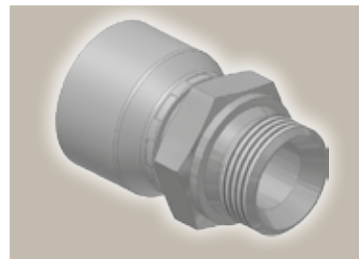
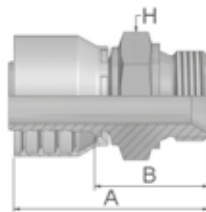

Referencia		D.I. de manguera				Rosca	A	B	H
		DN	Pulg.	Tamaño	mm	BSP	mm	mm	mm
1D946-2-4	1D948-2-4	6	1/4	-4	6,4	1/8x28	46	22	14
1D946-4-4	1D948-4-4	6	1/4	-4	6,4	1/4x19	51	27	19
1D946-6-4	1D948-6-4	6	1/4	-4	6,4	3/8x19	53	31	22
1D946-8-4	1D948-8-4	6	1/4	-4	6,4	1/2x14	54	52	27
1D946-4-5		8	5/16	-5	7,9	1/4x19	50	27	19
	1D948-4-5	8	5/16	-5	7,9	1/4x19	49	27	19
1D946-6-5	1D948-6-5	8	5/16	-5	7,9	3/8x19	55	31	22
1D946-4-6		10	3/8	-6	9,5	1/4x19	49	27	19
	1D948-4-6	10	3/8	-6	9,5	1/4x19	50	27	19
1D946-6-6	1D948-6-6	10	3/8	-6	9,5	3/8x19	54	31	22
1D946-8-6	1D948-8-6	10	3/8	-6	9,5	1/2x14	56	33	27
1D946-6-8	1D948-6-8	12	1/2	-8	12,7	3/8x19	54	30	22
1D946-8-8	1D948-8-8	12	1/2	-8	12,7	1/2x14	57	33	27
1D946-10-8	1D948-10-8	12	1/2	-8	12,7	5/8x14	58	35	30
1D946-12-8	1D948-12-8	12	1/2	-8	12,7	3/4x14	60	36	32
1D946-8-10	1D948-8-10	16	5/8	-10	15,9	1/2x14	58	33	27
1D946-10-10	1D948-10-10	16	5/8	-10	15,9	5/8x14	60	35	30
1D946-12-10	1D948-12-10	16	5/8	-10	15,9	3/4x14	62	37	32
1D946-12-12	1D948-12-12	19	3/4	-12	19,1	3/4x14	62	36	32
1D946-16-12	1D948-16-12	19	3/4	-12	19,1	1x11	67	41	41
1D946-16-16	1D948-16-16	25	1	-16	25,4	1x11	72	42	41
1D946-20-16	1D948-20-16	25	1	-16	25,4	1 1/4x11	75	46	50
1D946-20-20		31	1 1/4	-20	31,8	1 1/4x11	85	47	50
	1D948-20-20	31	1 1/4	-20	31,8	1 1/4x11	92	45	50
	1D948-24-24	38	1 1/2	-24	38,1	1 1/2x11	87	49	60
	1D948-32-32	51	2	-32	50,8	2x11	102	54	70

Disponible también en acero inoxidable.

Serie de terminales aprobados para tipos de manguera, dependiendo del tamaño:

46	o	48	441	441RH	461LT	462	462ST	462TC	462ST	629PU	692PU Twin						
46	463	492	492ST	492TC	692	692Twin	692TC	BCH1									
48	301SN	301TC	304	387	387ST	387TC	421RH	421SN	426	436	441RH	462PU	462PU Twin	BCH2	HT2	...	
	471TC	477	477ST	477TC	477RH	487	487ST	487TC	493	787	787TC	787ST	797	797TC	797ST	811	881

91 Macho cónico BSP Rígido - Recto

BS5200 - AGR-K

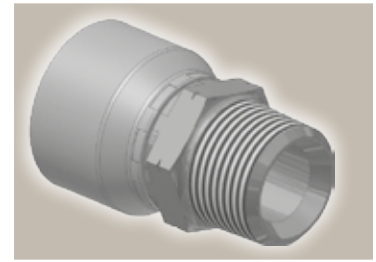
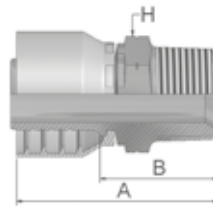

Referencia		D.I. de manguera				Rosca	A	B	H
Terminales Serie 46	Terminales Serie 48	DN	Pulg.	Tamaño	mm	BSP	mm	mm	mm
19146-4-4	19148-4-4	6	1/4	-4	6,4	1/4x19	49	26	14
	19148-6-4	6	1/4	-4	6,4	3/8x19	51	28	17
19146-4-5	19148-4-5	8	5/16	-5	7,9	1/4x19	49	25	14
19146-6-5	19148-6-5	8	5/16	-5	7,9	3/8x19	48	24	19
	19148-4-6	10	3/8	-6	9,5	1/4x19	46	24	14
19146-6-6	19148-6-6	10	3/8	-6	9,5	3/8x19	52	27	19
19146-8-6	19148-8-6	10	3/8	-6	9,5	1/2x14	57	34	22
	19148-6-8	12	1/2	-8	12,7	3/8x19	48	25	19
19146-8-8	19148-8-8	12	1/2	-8	12,7	1/2x14	57	33	22
	19148-12-10	16	5/8	-10	15,9	3/4x14	63	37	30
19146-12-12	19148-12-12	19	3/4	-12	19,1	3/4x14	63	37	30
19146-16-16	19148-16-16	25	1	-16	25,4	1x11	72	42	36

B5 Hembra giratoria BSP Cilíndrica Recta (Asiento plano)

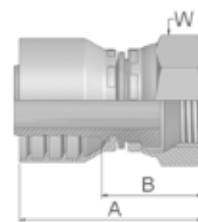

Referencia		D.I. de manguera				Rosca	A	B	W
Terminales Serie 46	Terminales Serie 48	DN	Pulg.	Tamaño	mm	BSP	mm	mm	mm
1B546-4-4	1B548-4-4	6	1/4	-4	6,4	1/4x19	41	17	19
1B546-4-5	1B548-4-5	8	5/16	-5	7,9	1/4x19	41	17	19
1B546-6-5	1B548-6-5	8	5/16	-5	7,9	3/8x19	38	14	22
1B546-8-5	1B548-8-5	8	5/16	-5	7,9	1/2x14	44	21	27
1B546-6-6	1B548-6-6	10	3/8	-6	9,5	3/8x19	37	14	22
1B546-8-6	1B548-8-6	10	3/8	-6	9,5	1/2x14	43	20	27
1B546-8-8	1B548-8-8	12	1/2	-8	12,7	1/2x14	43	19	27
1B546-12-8	1B548-12-8	12	1/2	-8	12,7	3/4x14	43	19	32
1B546-12-10	1B548-12-10	16	5/8	-10	15,9	3/4x14	43	18	32
1B546-12-12	1B548-12-12	19	3/4	-12	19,1	3/4x14	44	18	32
1B546-16-16	1B548-16-16	25	1	-16	25,4	1x11	51	21	41

Disponible también en acero inoxidable.

Serie de terminales aprobados para tipos de manguera, dependiendo del tamaño:

- 46 o 48 441 441RH 461LT 462 462ST 462TC 462ST 629PU 692PU Twin
- 46 463 492 492ST 492TC 692 692Twin 692TC BCH1
- 48 301SN 301TC 304 387 387ST 387TC 421RH 421SN 426 436 441RH 462PU 462PU Twin BCH2 HT2 ...
- 471TC 477 477ST 477TC 477RH 487 487ST 487TC 493 787 787TC 787ST 797 797TC 797ST 811 881

01 Macho NPTF fijo Rígido – Recto

SAE J476A / J516 – AGN

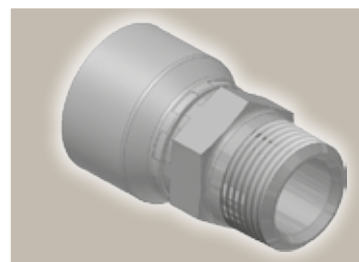
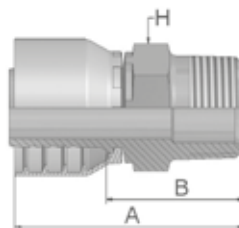

Referencia		D.I. de manguera				Rosca NPTF	A	B	H
Terminales Serie 46	Terminales Serie 48	DN	Pulg.	Tamaño	mm		mm	mm	mm
10146-2-4	10148-2-4	6	1/4	-4	6,4	1/8-27	48	24	12
10146-4-4	10148-4-4	6	1/4	-4	6,4	1/4-18	53	29	14
10146-6-4	10148-6-4	6	1/4	-4	6,4	3/8-18	55	31	19
10146-4-5	10148-4-5	8	5/16	-5	7,9	1/4-18	53	29	14
10146-6-5	10148-6-5	8	5/16	-5	7,9	3/8-18	55	31	19
10146-4-6	10148-4-6	10	3/8	-6	9,5	1/4-18	52	29	14
10146-6-6	10148-6-6	10	3/8	-6	9,5	3/8-18	54	31	19
10146-8-6	10148-8-6	10	3/8	-6	9,5	1/2-14	55	32	22
10146-6-8	10148-6-8	12	1/2	-8	12,7	3/8-18	55	32	19
10146-8-8	10148-8-8	12	1/2	-8	12,7	1/2-14	61	38	22
10146-8-10	10148-8-10	16	5/8	-10	15,9	1/2-14	63	38	22
10146-12-10	10148-12-10	16	5/8	-10	15,9	3/4-14	59	34	27
10146-12-12	10148-12-12	19	3/4	-12	19,1	3/4-14	60	34	27
10146-16-16	10148-16-16	25	1	-16	25,4	1-11 1/2	75	45	36
10146-20-20		31	1 1/4	-20	31,8	1 1/4-11 1/2	86	48	46
	10148-20-20	31	1 1/4	-20	31,8	1 1/4-11 1/2	104	57	46
	10148-24-24	38	1 1/2	-24	38,1	1 1/2-11 1/2	89	51	50
	10148-32-32	51	2	-32	50,8	2-11 1/2	104	55	65

Serie de terminales aprobados para tipos de manguera, dependiendo del tamaño:

Disponible también en acero inoxidable.

46	o	48	441	441RH	461LT	462	462ST	462TC	462ST	629PU	692PU Twin						
46	463	492	492ST	492TC	692	692Twin	692TC	BCH1									
48	301SN	301TC	304	387	387ST	387TC	421RH	421SN	426	436	441RH	462PU	462PU Twin	BCH2	HT2	...	
	471TC	477	477ST	477TC	477RH	487	487ST	487TC	493	787	787TC	787ST	797	797TC	797ST	811	881

03 Macho JIC 37° Rígido - Recto

ISO12151-5-S - AGJ

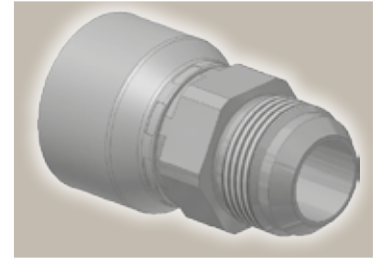
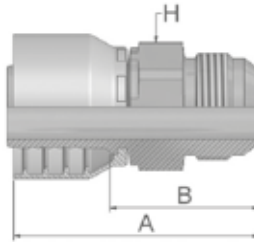

Referencia		D.I. de manguera				Rosca	A	B	H
Terminales Serie 46	Terminales Serie 48	DN	Pulg.	Tamaño	mm	UNF	mm	mm	mm
10346-4-4	10348-4-4	6	1/4	-4	6,4	7/16x20	52	29	14
10346-5-4	10348-5-4	6	1/4	-4	6,4	1/2x20	52	29	14
10346-6-4	10348-6-4	6	1/4	-4	6,4	9/16x18	55	31	19
10346-5-5	10348-5-5	8	5/16	-5	7,9	1/2x20	50	26	14
10346-6-5	10348-6-5	8	5/16	-5	7,9	9/16x18	55	31	19
10346-8-5	10348-8-5	8	5/16	-5	7,9	3/4x16	57	33	19
10346-4-6	10348-4-6	10	3/8	-6	9,5	7/16x20	54	31	19
10346-5-6	10348-5-6	10	3/8	-6	9,5	1/2x20	53	30	19
10346-6-6	10348-6-6	10	3/8	-6	9,5	9/16x18	56	31	19
10346-8-6	10348-8-6	10	3/8	-6	9,5	3/4x16	53	30	22
10346-10-6	10348-10-6	10	3/8	-6	9,5	7/8x14	56	33	24
10346-8-8	10348-8-8	12	1/2	-8	12,7	3/4x16	57	34	22
10346-10-8	10348-10-8	12	1/2	-8	12,7	7/8x14	56	32	24
10346-12-8	10348-12-8	12	1/2	-8	12,7	1 1/16x12	62	38	27
10346-10-10	10348-10-10	16	5/8	-10	15,9	7/8x14	63	38	24
10346-12-10	10348-12-10	16	5/8	-10	15,9	1 1/16x12	64	39	27
10346-12-12	10348-12-12	19	3/4	-12	19,1	1 1/16x12	68	42	27
10346-14-12	10348-14-12	19	3/4	-12	19,1	1 3/16x12	68	42	30
10346-16-12	10348-16-12	19	3/4	-12	19,1	1 5/16x12	64	38	36
10346-16-16	10348-16-16	25	1	-16	25,4	1 5/16x12	76	46	36
10346-20-16	10348-20-16	25	1	-16	25,4	1 5/8x12	73	43	46
10346-20-20		31	1 1/4	-20	31,8	1 5/8x12	86	48	46
	10348-20-20	31	1 1/4	-20	31,8	1 5/8x12	101	53	46
	10348-24-24	38	1 1/2	-24	38,1	1 7/8x12	85	47	50
	10348-32-32	51	2	-32	50,8	2 1/2x12	109	61	65

Disponible también en acero inoxidable.

Serie de terminales aprobados para tipos de manguera, dependiendo del tamaño:

46	o	48	441	441RH	461LT	462	462ST	462TC	462ST	629PU	692PU Twin						
46	463	492	492ST	492TC	692	692Twin	692TC	BCH1									
48	301SN	301TC	304	387	387ST	387TC	421RH	421SN	426	436	441RH	462PU	462PU Twin	BCH2	HT2	...	
	471TC	477	477ST	477TC	477RH	487	487ST	487TC	493	787	787TC	787ST	797	797TC	797ST	811	881

05 Macho recto SAE con junta tórica Rígido – Recto

ISO 11926 – SAE J516

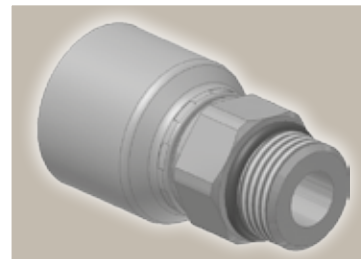
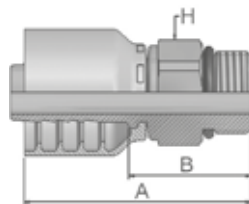

Referencia		D.I. de manguera				Rosca	A	B	H
Terminales Serie 46	Terminales Serie 48	DN	Pulg.	Tamaño	mm	UNF	mm	mm	mm
	10548-6-6	10	3/8	-6	9,5	9/16 18	47	24	17
10546-8-6	10548-8-6	10	3/8	-6	9,5	3/4x16	48	25	22
10546-8-8	10548-8-8	12	1/2	-8	12,7	3/4x16	52	28	22
10546-10-8	10548-10-8	12	1/2	-8	12,7	7/8x14	49	26	27

Serie de terminales aprobados para tipos de manguera, dependiendo del tamaño:

Disponible también en acero inoxidable.

46	o	48	441	441RH	461LT	462	462ST	462TC	462ST	629PU	692PU Twin						
46	463	492	492ST	492TC	692	692Twin	692TC	BCH1									
48	301SN	301TC	304	387	387ST	387TC	421RH	421SN	426	436	441RH	462PU	462PU Twin	BCH2	HT2	...	
	471TC	477	477ST	477TC	477RH	487	487ST	487TC	493	787	787TC	787ST	797	797TC	797ST	811	881

06/68 Hembra giratoria doble Asiento JIC 37° / SAE 45° Recta

ISO12151-5-SWS - DKJ

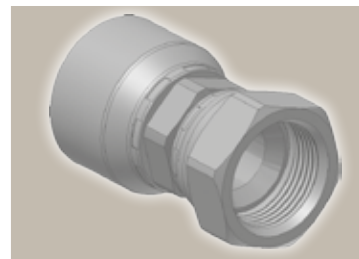
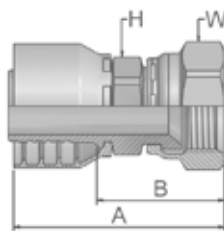

Referencia		D.I. de manguera				Rosca	A	B	H	W
Terminales Serie 46	Terminales Serie 48	DN	Pulg.	Tamaño	mm	UNF	mm	mm	mm	mm
16846-4-4	16848-4-4	6	1/4	-4	6,4	7/16x20	52	29	14	17
16846-5-4		6	1/4	-4	6,4	1/2x20	53	30	14	17
	16848-5-4	6	1/4	-4	6,4	1/2x20	54	30	14	17
10646-6-4	10648-6-4	6	1/4	-4	6,4	9/16x18	55	31	14	19
16846-5-5		8	5/16	-5	7,9	1/2x20	54	31	14	17
	16848-5-5	8	5/16	-5	7,9	1/2x20	54	30	14	17
10646-6-5	10648-6-5	8	5/16	-5	7,9	9/16x18	53	29	14	19
16846-8-5	16848-8-5	8	5/16	-5	7,9	3/4x16	57	34	17	22
16846-4-6	16848-4-6	10	3/8	-6	9,5	7/16x20	50	27	14	17
16846-5-6		10	3/8	-6	9,5	1/2x20	51	29	14	17
	16848-5-6	10	3/8	-6	9,5	1/2x20	52	29	14	17
10646-6-6	10648-6-6	10	3/8	-6	9,5	9/16x18	52	30	17	19
16846-8-6	16848-8-6	10	3/8	-6	9,5	3/4x16	56	34	17	22
16846-10-6	16848-10-6	10	3/8	-6	9,5	7/8x14	59	36	22	27
10646-6-8	10648-6-8	12	1/2	-8	12,7	9/16x18	55	32	22	19
16846-8-8	16848-8-8	12	1/2	-8	12,7	3/4x16	56	32	22	22
16846-10-8	16848-10-8	12	1/2	-8	12,7	7/8x14	62	38	22	27
10646-12-8	10648-12-8	12	1/2	-8	12,7	1 1/16x12	62	39	27	32
16846-8-10	16848-8-10	16	5/8	-10	15,9	3/4x16	57	32	22	22
16846-10-10	16848-10-10	16	5/8	-10	15,9	7/8x14	60	35	22	27
10646-12-10	10648-12-10	16	5/8	-10	15,9	1 1/16x12	64	39	27	32
16846-8-12	16848-8-12	19	3/4	-12	19,1	3/4x16	58	32	24	22
16846-10-12	16848-10-12	19	3/4	-12	19,1	7/8x14	61	35	24	27
10646-12-12	10648-12-12	19	3/4	-12	19,1	1 1/16x12	67	41	27	32
10646-14-12	10648-14-12	19	3/4	-12	19,1	1 3/16x12	68	42	30	36
10646-16-12	10648-16-12	19	3/4	-12	19,1	1 5/16x12	71	45	32	41
10646-12-16	10648-12-16	25	1	-16	25,4	1 1/16x12	73	44	32	32
10646-16-16	10648-16-16	25	1	-16	25,4	1 5/16x12	75	46	32	41
10646-20-16	10648-20-16	25	1	-16	25,4	1 5/8x12	80	50	41	50
10646-16-20		31	1 1/4	-20	31,8	1 5/16x12	87	49	41	41
	10648-16-20	31	1 1/4	-20	31,8	1 5/16x12	97	50	46	41
10646-20-20		31	1 1/4	-20	31,8	1 5/8x12	89	51	46	50
	10648-20-20	31	1 1/4	-20	31,8	1 5/8x12	100	53	46	50
	10648-24-24	38	1 1/2	-24	38,1	1 7/8x12	98	60	55	60
	10648-32-32	51	2	-32	50,8	2 1/2x12	120	72	65	75

Disponible también en acero inoxidable.

Serie de terminales aprobados para tipos de manguera, dependiendo del tamaño:

46	o	48	441	441RH	461LT	462	462ST	462TC	462ST	629PU	692PU Twin						
46	463	492	492ST	492TC	692	692Twin	692TC	BCH1									
48	301SN	301TC	304	387	387ST	387TC	421RH	421SN	426	436	441RH	462PU	462PU Twin	BCH2	HT2	...	
	471TC	477	477ST	477TC	477RH	487	487ST	487TC	493	787	787TC	787ST	797	797TC	797ST	811	881

08 Hembra giratoria SAE 45° Recta

SAE J516

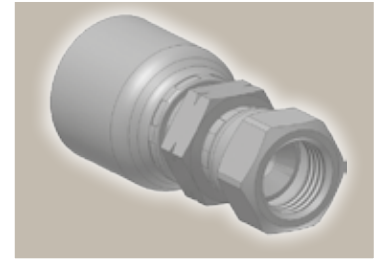
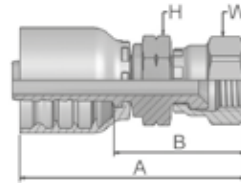

Referencia		D.I. de manguera				Rosca	A	B	H	W
Terminales Serie 46	Terminales Serie 48	DN	Pulg.	Tamaño	mm	UNF	mm	mm	mm	mm
10846-6-6	10848-6-6	10	3/8	-6	9,5	5/8x18	57		34	19

Serie de terminales aprobados para tipos de manguera, dependiendo del tamaño:

Disponible también en acero inoxidable.

46	o	48	441	441RH	461LT	462	462ST	462TC	462ST	629PU	692PU Twin						
46	463	492	492ST	492TC	692	692Twin	692TC	BCH1									
48	301SN	301TC	304	387	387ST	387TC	421RH	421SN	426	436	441RH	462PU	462PU Twin	BCH2	HT2	...	
	471TC	477	477ST	477TC	477RH	487	487ST	487TC	493	787	787TC	787ST	797	797TC	797ST	811	881

37/3V Hembra giratoria doble Asiento JIC 37° / SAE 45° Codo 45°

ISO 12151-5-SWE 45° – DKJ 45°

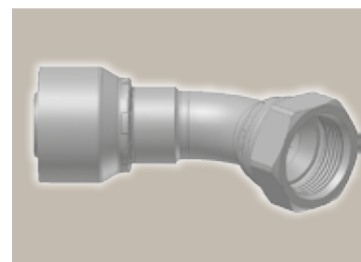
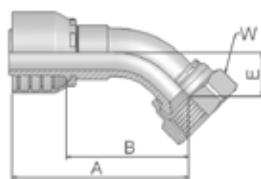

Referencia		D.I. de manguera				Rosca	A	B	E	W
Terminales Serie 46	Terminales Serie 48	DN	Pulg.	Tamaño	mm	UNF	mm	mm	mm	mm
13V46-4-4	13V48-4-4	6	1/4	-4	6,4	7/16x20	53	29	10	17
13V46-5-4	13V48-5-4	6	1/4	-4	6,4	1/2x20	57	33	9	17
13746-6-4	13748-6-4	6	1/4	-4	6,4	9/16x18	55	31	11	19
13V46-5-5	13V48-5-5	8	5/16	-5	7,9	1/2x20	53	29	10	17
13746-6-5	13748-6-5	8	5/16	-5	7,9	9/16x18	58	35	10	19
13746-6-6	13748-6-6	10	3/8	-6	9,5	9/16x18	60	37	11	19
13V46-8-6	13V48-8-6	10	3/8	-6	9,5	3/4x16	67	44	15	22
13V46-10-6	13V48-10-6	10	3/8	-6	9,5	7/8 14	69	46	17	27
13V46-8-8	13V48-8-8	12	1/2	-8	12,7	3/4x16	61	37	15	22
13V46-10-8	13V48-10-8	12	1/2	-8	12,7	7/8x14	70	46	16	27
13V46-10-10	13V48-10-10	16	5/8	-10	15,9	7/8x14	69	44	16	27
13746-12-10	13748-12-10	16	5/8	-10	15,9	1 1/16x12	74	49	21	32
13746-12-12	13748-12-12	19	3/4	-12	19,1	1 1/16x12	83	58	22	32
13746-14-12	13748-14-12	19	3/4	-12	19,1	1 3/16x12	84	58	22	36
13746-16-12	13748-16-12	19	3/4	-12	19,1	1 5/16x12	84	58	24	41
13746-12-16	13748-12-16	25	1	-16	25,4	1 1/16x12	91	61	21	32
13746-16-16	13748-16-16	25	1	-16	25,4	1 5/16x12	99	70	24	41
13746-20-16	13748-20-16	25	1	-16	25,4	1 5/8x12	101	71	26	50
13746-20-20		31	1 1/4	-20	31,8	1 5/8x12	129	91	31	50
	13748-20-20	31	1 1/4	-20	31,8	1 5/8x12	134	87	30	50
	13748-24-24	38	1 1/2	-24	38,1	1 7/8x12	165	127	58	60

Serie de terminales aprobados para tipos de manguera, dependiendo del tamaño:

Disponible también en acero inoxidable.

46	o	48	441	441RH	461LT	462	462ST	462TC	462ST	629PU	692PU Twin						
46	463	492	492ST	492TC	692	692Twin	692TC	BCH1									
48	301SN	301TC	304	387	387ST	387TC	421RH	421SN	426	436	441RH	462PU	462PU Twin	BCH2	HT2	...	
	471TC	477	477ST	477TC	477RH	487	487ST	487TC	493	787	787TC	787ST	797	797TC	797ST	811	881

39/3W Hembra giratoria doble Asiento JIC 37° / SAE 45° Codo 90°

ISO 12151-5-SWES – DKJ 90°

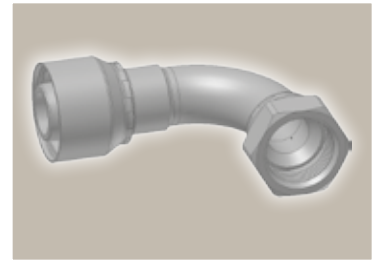
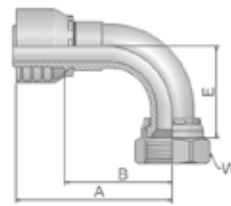

Referencia		D.I. de manguera				Rosca	A	B	E	W
Terminales Serie 46	Terminales Serie 48	DN	Pulg.	Tamaño	mm	UNF	mm	mm	mm	mm
13W46-4-4	13W48-4-4	6	1/4	-4	6,4	7/16x20	48	24	21	17
13W46-5-4	13W48-5-4	6	1/4	-4	6,4	1/2x20	57	34	21	17
13946-6-4	13948-6-4	6	1/4	-4	6,4	9/16x18	49	25	23	19
13W46-5-5	13W48-5-5	8	5/16	-5	7,9	1/2x20	49	25	21	17
13946-6-5	13948-6-5	8	5/16	-5	7,9	9/16x18	51	28	23	19
13W46-4-6	13W48-4-6	10	3/8	-6	9,5	7/16x20	46	23	21	17
13946-6-6	13948-6-6	10	3/8	-6	9,5	9/16x18	51	28	23	19
13W46-8-6	13W48-8-6	10	3/8	-6	9,5	3/4x16	59	36	29	22
13W46-10-6	13W48-10-6	10	3/8	-6	9,5	7/8x14	61	38	32	27
13946-6-8	13948-6-8	12	1/2	-8	12,7	9/16x18	54	30	23	19
13W46-8-8	13W48-8-8	12	1/2	-8	12,7	3/4x16	55	31	29	22
13W46-10-8	13W48-10-8	12	1/2	-8	12,7	7/8x14	63	39	32	27
13W46-10-10	13W48-10-10	16	5/8	-10	15,9	7/8x14	64	39	33	27
13946-12-10	13948-12-10	16	5/8	-10	15,9	1 1/16x12	74	49	48	32
13946-12-12	13948-12-12	19	3/4	-12	19,1	1 1/16x12	80	54	48	32
13946-14-12	13948-14-12	19	3/4	-12	19,1	1 3/16x12	80	54	51	36
13946-16-12	13948-16-12	19	3/4	-12	19,1	1 5/16x12	80	54	56	41
13946-12-16	13948-12-16	25	1	-16	25,4	1 1/16x12	87	58	48	32
13946-16-16	13948-16-16	25	1	-16	25,4	1 5/16x12	98	68	56	41
13946-20-16	13948-20-16	25	1	-16	25,4	1 5/8x12	98	68	62	50
13946-20-20		31	1 1/4	-20	31,8	1 5/8x12	124	86	70	50
	13948-20-20	31	1 1/4	-20	31,8	1 5/8x12	129	82	70	50
	13948-24-24	38	1 1/2	-24	38,1	1 7/8x12	140	102	91	60

Disponible también en acero inoxidable.

Serie de terminales aprobados para tipos de manguera, dependiendo del tamaño:

46	o	48	441	441RH	461LT	462	462ST	462TC	462ST	629PU	692PU Twin						
46	463	492	492ST	492TC	692	692Twin	692TC	BCH1									
48	301SN	301TC	304	387	387ST	387TC	421RH	421SN	426	436	441RH	462PU	462PU Twin	BCH2	HT2	...	
	471TC	477	477ST	477TC	477RH	487	487ST	487TC	493	787	787TC	787ST	797	797TC	797ST	811	881

41/3Y Hembra giratoria doble Asiento JIC 37° / SAE 45° Codo 90° (Largo)

ISO 12151-5-SWEL – DKJ 90°L

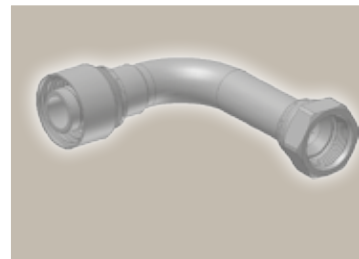
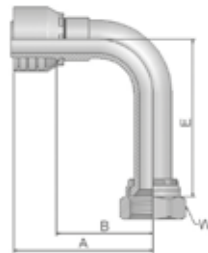

Referencia		D.I. de manguera				Rosca	A	B	E	W
Terminales Serie 46	Terminales Serie 48	DN	Pulg.	Tamaño	mm	UNF	mm	mm	mm	mm
13Y46-4-4	13Y48-4-4	6	1/4	-4	6,4	7/16x20	61	37	46	17
14146-6-4	14148-6-4	6	1/4	-4	6,4	9/16x18	57	34	55	19
14146-6-6	14148-6-6	10	3/8	-6	9,5	9/16x18	57	34	54	19
13Y46-8-6		10	3/8	-6	9,5	3/4x16	59	36,5	62	22
	13Y48-8-6	10	3/8	-6	9,5	3/4x16	55	32	62	22
13Y46-8-8	13Y48-8-8	12	1/2	-8	12,7	3/4x16	59	36	64	22
13Y46-10-10	13Y48-10-10	16	5/8	-10	15,9	7/8x14	61	36	70	27
14146-12-12	14148-12-12	19	3/4	-12	19,1	1 1/16x12	80	54	96	32
14146-16-16	14148-16-16	25	1	-16	25,4	1 5/16x12	98	68	110	41

Serie de terminales aprobados para tipos de manguera, dependiendo del tamaño:

Disponible también en acero inoxidable.

46	o	48	441	441RH	461LT	462	462ST	462TC	462ST	629PU	692PU	692PU Twin					
46	463	492	492ST	492TC	692	692Twin	692TC	BCH1									
48	301SN	301TC	304	387	387ST	387TC	421RH	421SN	426	436	441RH	462PU	462PU Twin	BCH2	HT2	...	
	471TC	477	477ST	477TC	477RH	487	487ST	487TC	493	787	787TC	787ST	797	797TC	797ST	811	881

15 Brida ISO 6162-1 Recta

ISO 12151-3-S-L – SFL
(21,0 MPa/ 3000 psi)

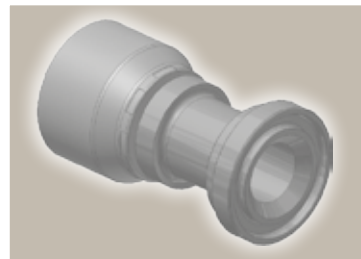
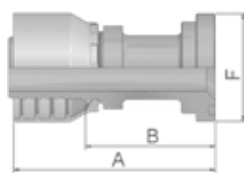

Referencia		D.I. de manguera				Terminal	A	B	F
Terminales Serie 46	Terminales Serie 48	DN	Pulg.	Tamaño	mm	Pulg.	mm	mm	mm
11546-8-8	11548-8-8	12	1/2	-8	12,7	1/2	74	50	30
11546-12-8	11548-12-8	12	1/2	-8	12,7	3/4	51	27	38
11546-12-10	11548-12-10	16	5/8	-10	15,9	3/4	55	30	38
11546-12-12	11548-12-12	19	3/4	-12	19,1	3/4	81	55	38
11546-16-12	11548-16-12	19	3/4	-12	19,1	1	56	30	45
11546-20-12	11548-20-12	19	3/4	-12	19,1	1 1/4	77	51	51
11546-16-16	11548-16-16	25	1	-16	25,4	1	84	54	45
11546-20-16	11548-20-16	25	1	-16	25,4	1 1/4	65	35	51
11546-24-16	11548-24-16	25	1	-16	25,4	1 1/2	97	67	60
	11548-16-20	31	1 1/4	-20	31,8	1	111	64	45
11546-20-20		31	1 1/4	-20	31,8	1 1/4	114	76	51
	11548-20-20	31	1 1/4	-20	31,8	1 1/4	119	72	51
11546-24-20		31	1 1/4	-20	31,8	1 1/2	72	35	60
	11548-24-20	31	1 1/4	-20	31,8	1 1/2	82	35	60
	11548-32-20	31	1 1/4	-20	31,8	2	123	76	71
	11548-24-24	38	1 1/2	-24	38,1	1 1/2	117	79	60
	11548-32-24	38	1 1/2	-24	38,1	2	80	42	71
	11548-24-32	51	2	-32	50,8	1 1/2	129	81	60
	11548-32-32	51	2	-32	50,8	2	127	79	71

Serie de terminales aprobados para tipos de manguera, dependiendo del tamaño:

Disponible también en acero inoxidable.

46	o	48	441	441RH	461LT	462	462ST	462TC	462ST	629PU	692PU Twin						
46	463	492	492ST	492TC	692	692Twin	692TC	BCH1									
48	301SN	301TC	304	387	387ST	387TC	421RH	421SN	426	436	441RH	462PU	462PU Twin	BCH2	HT2	...	
	471TC	477	477ST	477TC	477RH	487	487ST	487TC	493	787	787TC	787ST	797	797TC	797ST	811	881

17 Brida ISO 6162-1 Codo 45°

ISO 12151-3 – E45 – L – SFL 45°
(35,0 MPa/ 5000 psi)

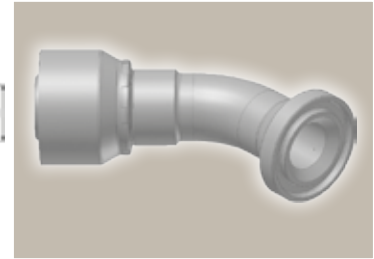
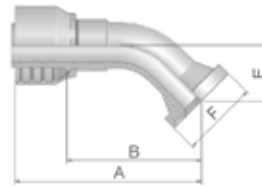

Referencia		D.I. de manguera				Terminal	A	B	E	F
		DN	Pulg.	Tamaño	mm	Pulg.	mm	mm	mm	mm
11746-8-8	11748-8-8	12	1/2	-8	12,7	1/2	72	48	20	30
11746-12-8	11748-12-8	12	1/2	-8	12,7	3/4	70	47	21	38
11746-12-10	11748-12-10	16	5/8	-10	15,9	3/4	75	50	24	38
11746-12-12	11748-12-12	19	3/4	-12	19,1	3/4	88	62	26	38
11746-16-12	11748-16-12	19	3/4	-12	19,1	1	88	62	26	45
11746-20-12	11748-20-12	19	3/4	-12	19,1	1 1/4	87	61	25	51
11746-16-16		25	1	-16	25,4	1	109	78	32	45
	11748-16-16	25	1	-16	25,4	1	107	78	32	45
11746-20-16	11748-20-16	25	1	-16	25,4	1 1/4	109	79	32	51
	11748-16-20	31	1 1/4	-20	31,8	1	141	94	38	45
11746-20-20		31	1 1/4	-20	31,8	1 1/4	136	98	38	51
	11748-20-20	31	1 1/4	-20	31,8	1 1/4	141	94	38	51
11746-24-20		31	1 1/4	-20	31,8	1 1/2	136	98	38	60
	11748-24-20	31	1 1/4	-20	31,8	1 1/2	141	94	38	60
	11748-24-24	38	1 1/2	-24	38,1	1 1/2	151	113	44	60
	11748-32-24	38	1 1/2	-24	38,1	2	150	112	44	71
	11748-24-32	51	2	-32	50,8	1 1/2	164	115	44	60
	11748-32-32	51	2	-32	50,8	2	202	153	56	71

Disponible también en acero inoxidable.

Serie de terminales aprobados para tipos de manguera, dependiendo del tamaño:

46	o	48	441	441RH	461LT	462	462ST	462TC	462ST	629PU	692PU Twin						
46	463	492	492ST	492TC	692	692Twin	692TC	BCH1									
48	301SN	301TC	304	387	387ST	387TC	421RH	421SN	426	436	441RH	462PU	462PU Twin	BCH2	HT2	...	
	471TC	477	477ST	477TC	477RH	487	487ST	487TC	493	787	787TC	787ST	797	797TC	797ST	811	881

19 Brida ISO 6162-1 Codo 90°

ISO 12151-3 – E– L – SFL 90°
(21,0 MPa/ 3000 psi)

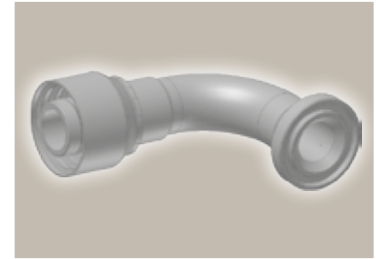
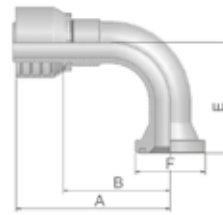

Referencia		D.I. de manguera				Terminal	A	B	E	F
Terminales Serie 46	Terminales Serie 48	DN	Pulg.	Tamaño	mm	Pulg.	mm	mm	mm	mm
11946-8-8	11948-8-8	12	1/2	-8	12,7	1/2	64	41	41	30
11946-12-8	11948-12-8	12	1/2	-8	12,7	3/4	70	47	43	38
11946-12-10	11948-12-10	16	5/8	-10	15,9	3/4	78	53	52	38
11946-16-10	11948-16-10	16	5/8	-10	15,9	1	78	53	53	45
11946-12-12	11948-12-12	19	3/4	-12	19,1	3/4	80	54	58	38
11946-16-12	11948-16-12	19	3/4	-12	19,1	1	80	54	58	45
11946-20-12	11948-20-12	19	3/4	-12	19,1	1 1/4	80	54	54	51
11946-12-16	11948-12-16	25	1	-16	25,4	3/4	98	68	70	38
11946-16-16	11948-16-16	25	1	-16	25,4	1	98	68	70	45
11946-20-16	11948-20-16	25	1	-16	25,4	1 1/4	98	68	69	51
	11948-24-16	25	1	-16	25,4	1 1/2	100	70	62	60
	11948-16-20	31	1 1/4	-20	31,8	1	129	82	90	45
11946-20-20		31	1 1/4	-20	31,8	1 1/4	124	86	90	51
	11948-20-20	31	1 1/4	-20	31,8	1 1/4	130	83	90	51
11946-24-20		31	1 1/4	-20	31,8	1 1/2	124	86	90	60
	11948-24-20	31	1 1/4	-20	31,8	1 1/2	129	82	90	60
	11948-32-20	31	1 1/4	-20	31,8	2	130	83	67	71
	11948-24-24	38	1 1/2	-24	38,1	1 1/2	149	111	104	60
	11948-32-24	38	1 1/2	-24	38,1	2	139	101	104	71
	11948-24-32	51	2	-32	50,8	1 1/2	154	106	104	60
	11948-32-32	51	2	-32	50,8	2	180	132	138	71

Serie de terminales aprobados para tipos de manguera, dependiendo del tamaño:

Disponible también en acero inoxidable.

46	o	48	441	441RH	461LT	462	462ST	462TC	462ST	629PU	692PU Twin						
46	463	492	492ST	492TC	692	692Twin	692TC	BCH1									
48	301SN	301TC	304	387	387ST	387TC	421RH	421SN	426	436	441RH	462PU	462PU Twin	BCH2	HT2	...	
	471TC	477	477ST	477TC	477RH	487	487ST	487TC	493	787	787TC	787ST	797	797TC	797ST	811	881

6A Brida ISO 6162-2 Recta

ISO 12151-3-S-S – SFS
(42,0 MPa/ 6000 psi)

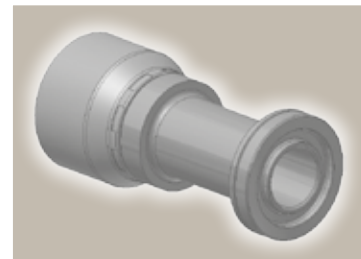
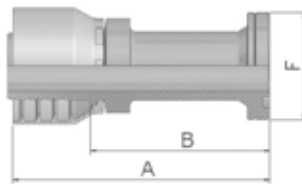

Referencia		D.I. de manguera				Terminal	A	B	F
Terminales Serie 46	Terminales Serie 48	DN	Pulg.	Tamaño	mm	Pulg.	mm	mm	mm
16A46-8-8	16A48-8-8	12	1/2	-8	12,7	1/2	75	51	32
	16A48-12-10	16	5/8	-10	15,9	3/4	60	35	41
16A46-12-12	16A48-12-12	19	3/4	-12	19,1	3/4	96	70	41
16A46-12-16	16A48-12-16	25	1	-16	25,4	3/4	99	69	41
16A46-16-16	16A48-16-16	25	1	-16	25,4	1	111	81	48
16A46-20-20		31	1 1/4	-20	31,8	1 1/4	122	84	54
	16A48-20-20	31	1 1/4	-20	31,8	1 1/4	130	83	54
	16A48-24-24	38	1 1/2	-24	38,1	1 1/2	139	101	64
	16A48-32-32	51	2	-32	50,8	2	172	124	79

6F Brida ISO 6162-2 Codo 45°

ISO 12151-3 – E45-S – SFS 45°
(42,0 MPa/ 6000 psi)

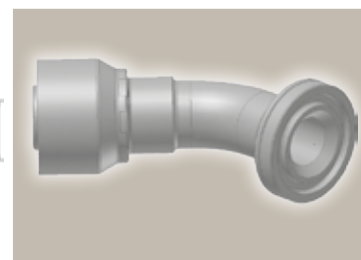
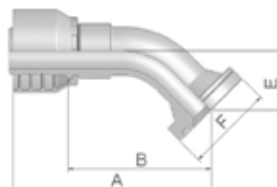

Referencia		D.I. de manguera				Terminal	A	B	E	F
Terminales Serie 46	Terminales Serie 48	DN	Pulg.	Tamaño	mm	Pulg.	mm	mm	mm	mm
16F46-12-12	16F48-12-12	19	3/4	-12	19,1	3/4	88	62	26	41
16F46-16-16	16F48-16-16	25	1	-16	25,4	1	107	78	32	48
	16F48-20-20	31	1 1/4	-20	31,8	1 1/4	141	94	38	54
	16F48-24-24	38	1 1/2	-24	38,1	1 1/2	150	112	44	64
	16F48-32-32	51	2	-32	50,8	2	200	152	56	79

Disponible también en acero inoxidable.

Serie de terminales aprobados para tipos de manguera, dependiendo del tamaño:

46	o	48	441	441RH	461LT	462	462ST	462TC	462ST	629PU	692PU Twin						
46	463	492	492ST	492TC	692	692Twin	692TC	BCH1									
48	301SN	301TC	304	387	387ST	387TC	421RH	421SN	426	436	441RH	462PU	462PU Twin	BCH2	HT2	...	
	471TC	477	477ST	477TC	477RH	487	487ST	487TC	493	787	787TC	787ST	797	797TC	797ST	811	881

6N Brida ISO 6162-2 Codo 90°

ISO 12151-3 – E-S – SFS 90°
(42,0 MPa/ 6000 psi)

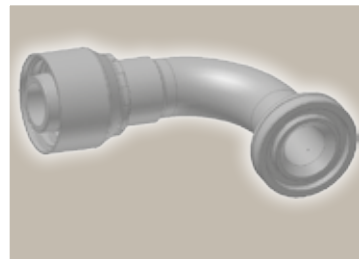
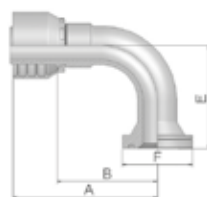

Referencia		D.I. de manguera				Terminal	A	B	E	F
Terminales Serie 46	Terminales Serie 48	DN	Pulg.	Tamaño	mm	Pulg.	mm	mm	mm	mm
16N46-8-12	16N48-8-12	19	3/4	-12	19,1	1/2	70	44	40	32
16N46-12-12	16N48-12-12	19	3/4	-12	19,1	3/4	80	54	54	41
16N46-16-12	16N48-16-12	19	3/4	-12	19,1	1	80	54	53	48
16N46-12-16	16N48-12-16	25	1	-16	25,4	3/4	88	58	70	41
16N46-16-16	16N48-16-16	25	1	-16	25,4	1	98	68	70	48
16N46-20-20		31	1 1/4	-20	31,8	1 1/4	124	86	90	54
	16N48-20-20	31	1 1/4	-20	31,8	1 1/4	129	82	90	54
	16N48-24-24	38	1 1/2	-24	38,1	1 1/2	139	101	104	64
	16N48-32-32	51	2	-32	50,8	2	186	138	138	79

Serie de terminales aprobados para tipos de manguera, dependiendo del tamaño:

Disponible también en acero inoxidable.

46	o	48	441	441RH	461LT	462	462ST	462TC	462ST	629PU	692PU	Twin					
46	463	492	492ST	492TC	692	692Twin	692TC	BCH1									
48	301SN	301TC	304	387	387ST	387TC	421RH	421SN	426	436	441RH	462PU	462PU Twin	BCH2	HT2	...	
	471TC	477	477ST	477TC	477RH	487	487ST	487TC	493	787	787TC	787ST	797	797TC	797ST	811	881

JC Hembra giratoria ORFS Recta - Corta

ISO 12151-1 - SWSA
SAE J516 - ORFS

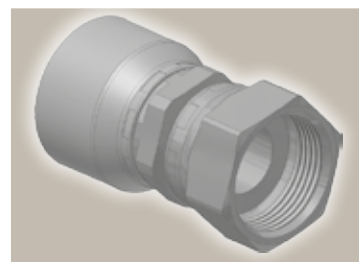
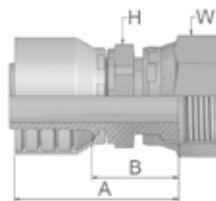

Referencia		D.I. de manguera				Rosca	A	B	H	W
Terminales Serie 46	Terminales Serie 48	DN	Pulg.	Tamaño	mm	UNF	mm	mm	mm	mm
1JC46-4-4	1JC48-4-4	6	1/4	-4	6,4	9/16x18	46	22	14	17
1JC46-6-4	1JC48-6-4	6	1/4	-4	6,4	11/16x16	45	23	17	22
1JC46-8-4	1JC48-8-4	6	1/4	-4	6,4	13/16x16	45	22	19	24
1JC46-6-5	1JC48-6-5	8	5/16	-5	7,9	11/16x16	47	23	17	22
1JC46-4-6	1JC48-4-6	10	3/8	-6	9,5	9/16x18	42	19	17	17
1JC46-6-6	1JC48-6-6	10	3/8	-6	9,5	11/16x16	43	21	17	22
1JC46-8-6	1JC48-8-6	10	3/8	-6	9,5	13/16x16	45	22	19	24
1JC46-6-8	1JC48-6-8	12	1/2	-8	12,7	11/16x16	44	20	17	22
1JC46-8-8	1JC48-8-8	12	1/2	-8	12,7	13/16x16	46	22	22	24
1JC46-10-8	1JC48-10-8	12	1/2	-8	12,7	1x14	48	24	24	30
1JC46-12-8	1JC48-12-8	12	1/2	-8	12,7	1 3/16x12	52	29	30	36
1JC46-8-10	1JC48-8-10	16	5/8	-10	15,9	13/16x16	47	22	22	24
1JC46-10-10	1JC48-10-10	16	5/8	-10	15,9	1x14	51	26	24	30
1JC46-12-10	1JC48-12-10	16	5/8	-10	15,9	1 3/16x12	54	28	30	36
1JC46-10-12	1JC48-10-12	19	3/4	-12	19,1	1x14	54	28	24	30
1JC46-12-12	1JC48-12-12	19	3/4	-12	19,1	1 3/16x12	55	29	30	36
1JC46-16-12	1JC48-16-12	19	3/4	-12	19,1	1 7/16x12	59	33	36	41
	1JC48-12-16	25	1	-16	25,4	1 3/16x12	60	30	32	36
1JC46-16-16	1JC48-16-16	25	1	-16	25,4	1 7/16x12	63	33	36	41
1JC46-20-16	1JC48-20-16	25	1	-16	25,4	1 11/16x12	62	32	41	50
1JC46-20-20		31	1 1/4	-20	31,8	1 11/16x12	71	33	41	50
	1JC48-20-20	31	1 1/4	-20	31,8	1 11/16x12	85	36	50	50

Disponible también en acero inoxidable.

Serie de terminales aprobados para tipos de manguera, dependiendo del tamaño:

46	o	48	441	441RH	461LT	462	462ST	462TC	462ST	629PU	692PU Twin						
46	463	492	492ST	492TC	692	692Twin	692TC	BCH1									
48	301SN	301TC	304	387	387ST	387TC	421RH	421SN	426	436	441RH	462PU	462PU Twin	BCH2	HT2	...	
	471TC	477	477ST	477TC	477RH	487	487ST	487TC	493	787	787TC	787ST	797	797TC	797ST	811	881

JS Hembra giratoria ORFS (Larga)

ISO 12151-1-SWSB
SAE J516 – ORFS

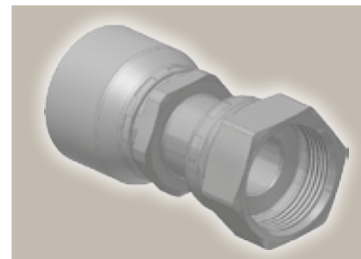
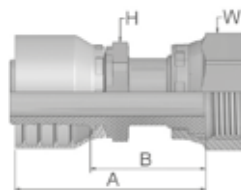

Referencia		D.I. de manguera				Rosca	A	B	H	W
Terminales Serie 46	Terminales Serie 48	DN	Pulg.	Tamaño	mm	UNF	mm	mm	mm	mm
1JS46-4-4		6	1/4	-4	6,4	9/16x18	53	29	14	17
	1JS48-4-4	6	1/4	-4	6,4	9/16x18	51	29	14	17
1JS46-6-4		6	1/4	-4	6,4	11/16x16	56	31	17	22
	1JS48-6-4	6	1/4	-4	6,4	11/16x16	54	31	17	22
1JS46-6-5	1JS48-6-5	8	5/16	-5	7,9	11/16x16	55	31	17	22
	1JS48-4-6	10	3/8	-6	9,5	9/16x18	53	31	14	17
1JS46-6-6	1JS48-6-6	10	3/8	-6	9,5	11/16x16	52	29	17	22
1JS46-8-6	1JS48-8-6	10	3/8	-6	9,5	13/16x16	58	35	19	24
1JS46-6-8	1JS48-6-8	12	1/2	-8	12,7	11/16x16	52	29	17	22
1JS46-8-8	1JS48-8-8	12	1/2	-8	12,7	13/16x16	57	33	22	24
1JS46-10-8	1JS48-10-8	12	1/2	-8	12,7	1x14	63	39	24	30
1JS46-10-10	1JS48-10-10	16	5/8	-10	15,9	1x14	65	39	24	30
1JS46-12-10	1JS48-12-10	16	5/8	-10	15,9	1 3/16x12	70	45	30	36
	1JS48-10-12	19	3/4	-12	19,1	1x14	65	39	24	30
1JS46-12-12	1JS48-12-12	19	3/4	-12	19,1	1 3/16x12	71	45	30	36
1JS46-16-12	1JS48-16-12	19	3/4	-12	19,1	1 7/16x12	73	47	36	41
1JS46-16-16	1JS48-16-16	25	1	-16	25,4	1 7/16x12	76	46	36	41
1JS46-20-20		31	1 1/4	-20	31,8	1 11/16x12	88	50	41	50
	1JS48-20-20	31	1 1/4	-20	31,8	1 11/16x12	102	54	46	50
	1JS48-24-24	38	1 1/2	-24	38,1	2x12	99	62	50	60

Serie de terminales aprobados para tipos de manguera, dependiendo del tamaño:

Disponible también en acero inoxidable.

46	o	48	441	441RH	461LT	462	462ST	462TC	462ST	629PU	692PU	Twin					
46	463	492	492ST	492TC	692	692Twin	692TC	BCH1									
48	301SN	301TC	304	387	387ST	387TC	421RH	421SN	426	436	441RH	462PU	462PU Twin	BCH2	HT2	...	
	471TC	477	477ST	477TC	477RH	487	487ST	487TC	493	787	787TC	787ST	797	797TC	797ST	811	881

J7 Hembra giratoria ORFS Codo 45°

ISO 12151-1 – SWE 45°
SAE J516 – ORFS 45°

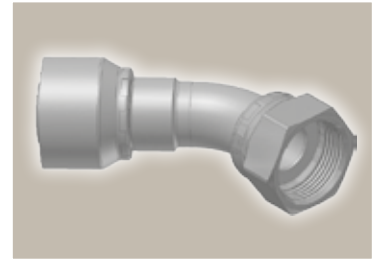
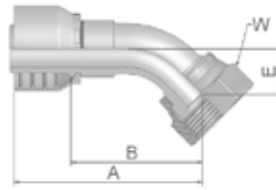

Referencia		D.I. de manguera				Rosca	A	B	E	W
Terminales Serie 46	Terminales Serie 48	DN	Pulg.	Tamaño	mm	UNF	mm	mm	mm	mm
1J746-4-4	1J748-4-4	6	1/4	-4	6,4	9/16x18	54	31	10	17
1J746-6-4	1J748-6-4	6	1/4	-4	6,4	11/16x16	53	30	11	22
1J746-8-4	1J748-8-4	6	1/4	-4	6,4	13/16x16	59	34	15	24
1J746-6-5	1J748-6-5	8	5/16	-5	7,9	11/16x16	56	32	11	22
1J746-6-6	1J748-6-6	10	3/8	-6	9,5	11/16x16	54	31	11	22
1J746-8-6	1J748-8-6	10	3/8	-6	9,5	13/16x16	59	36	15	24
1J746-6-8		12	1/2	-8	12,7	11/16x16	57	33	11	22
	1J748-6-8	12	1/2	-8	12,7	11/16	57	33	11	22
1J746-8-8	1J748-8-8	12	1/2	-8	12,7	13/16x16	61	38	15	24
1J746-10-8	1J748-10-8	12	1/2	-8	12,7	1x14	65	41	16	30
1J746-12-8	1J748-12-8	12	1/2	-8	12,7	1 3/16x12	77	53	21	36
1J746-10-10	1J748-10-10	16	5/8	-10	15,9	1x14	67	42	16	30
1J746-12-10	1J748-12-10	16	5/8	-10	15,9	1 3/16x12	80	55	21	36
1J746-10-12	1J748-10-12	19	3/4	-12	19,1	1x14	73	47	16	30
1J746-12-12	1J748-12-12	19	3/4	-12	19,1	1 3/16x12	83	57	21	36
1J746-16-12	1J748-16-12	19	3/4	-12	19,1	1 7/16x12	94	68	24	41
1J746-12-16	1J748-12-16	25	1	-16	25,4	1 3/16x12	91	61	21	36
1J746-16-16	1J748-16-16	25	1	-16	25,4	1 7/16x12	99	69	24	41
1J746-20-16	1J748-20-16	25	1	-16	25,4	1 11/16x12	101	71	25	50
1J746-20-20		31	1 1/4	-20	31,8	1 11/16x12	124	86	26	50
	1J748-20-20	31	1 1/4	-20	31,8	1 11/16x12	130	82	27	50
	1J748-24-24	38	1 1/2	-24	38,1	2x12	148	110	40	60

Disponible también en acero inoxidable.

Serie de terminales aprobados para tipos de manguera, dependiendo del tamaño:

46	o	48	441	441RH	461LT	462	462ST	462TC	462ST	629PU	692PU Twin						
46	463	492	492ST	492TC	692	692Twin	692TC	BCH1									
48	301SN	301TC	304	387	387ST	387TC	421RH	421SN	426	436	441RH	462PU	462PU Twin	BCH2	HT2	...	
	471TC	477	477ST	477TC	477RH	487	487ST	487TC	493	787	787TC	787ST	797	797TC	797ST	811	881

J9 Hembra giratoria ORFS Codo 90° - Corto

ISO 12151-1 - SWES
SAE J516 - ORFS 90°

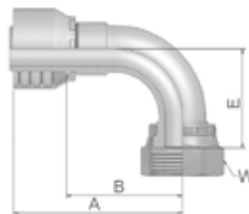

Referencia		D.I. de manguera				Rosca	A	B	E	W
Terminales Serie 46	Terminales Serie 48	DN	Pulg.	Tamaño	mm	UNF	mm	mm	mm	mm
1J946-4-4	1J948-4-4	6	1/4	-4	6,4	9/16x18	52	29	21	17
1J946-6-4	1J948-6-4	6	1/4	-4	6,4	11/16x16	51	27	23	22
	1J948-8-4	6	1/4	-4	6,4	13/16x16	50	26	29	24
1J946-6-5	1J948-6-5	8	5/16	-5	7,9	11/16x16	53	29	23	22
1J946-4-6	1J948-4-6	10	3/8	-6	9,5	9/16x18	47	24	21	17
1J946-6-6	1J948-6-6	10	3/8	-6	9,5	11/16x16	52	29	23	22
1J946-8-6	1J948-8-6	10	3/8	-6	9,5	13/16x16	53	30	29	24
1J946-6-8	1J948-6-8	12	1/2	-8	12,7	11/16x16	53	29	23	22
1J946-8-8	1J948-8-8	12	1/2	-8	12,7	13/16x16	55	32	29	24
1J946-10-8	1J948-10-8	12	1/2	-8	12,7	1x14	66	42	32	30
1J946-12-8	1J948-12-8	12	1/2	-8	12,7	1 3/16x12	58	34	48	36
1J946-10-10	1J948-10-10	16	5/8	-10	15,9	1x14	65	39	32	30
1J946-12-10	1J948-12-10	16	5/8	-10	15,9	1 3/16x12	71	45	48	36
1J946-10-12	1J948-10-12	19	3/4	-12	19,1	1x14	69	43	32	30
1J946-12-12	1J948-12-12	19	3/4	-12	19,1	1 3/16x12	80	54	48	36
1J946-16-12		19	3/4	-12	19,1	1 7/16x12	88	62	56	41
1J946-12-16		25	1	-16	25,4	1 3/16x12	88	58	48	36
	1J948-12-16	25	1	-16	25,4	1 3/16 12	88	58	48	36
1J946-16-16	1J948-16-16	25	1	-16	25,4	1 7/16x12	98	68	56	41
1J946-20-16	1J948-20-16	25	1	-16	25,4	1 11/16x12	104	74	64	50
1J946-20-20		31	1 1/4	-20	31,8	1 11/16x12	124	86	64	50
	1J948-20-20	31	1 1/4	-20	31,8	1 11/16x12	129	82	64	50
	1J948-24-24	38	1 1/2	-24	38,1	2x12	140	102	82	60

Serie de terminales aprobados para tipos de manguera, dependiendo del tamaño:

Disponible también en acero inoxidable.

46	o	48	441	441RH	461LT	462	462ST	462TC	462ST	629PU	692PU	Twin					
46	463	492	492ST	492TC	692	692Twin	692TC	BCH1									
48	301SN	301TC	304	387	387ST	387TC	421RH	421SN	426	436	441RH	462PU	462PU Twin	BCH2	HT2	...	
	471TC	477	477ST	477TC	477RH	487	487ST	487TC	493	787	787TC	787ST	797	797TC	797ST	811	881

J1 Hembra giratoria ORFS Codo 90° - Largo

ISO 12151-1 – SWEL
SAE J 516 – ORFS 90° L

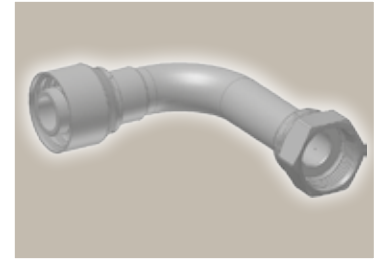

Referencia		D.I. de manguera				Rosca	A	B	E	W
Terminales Serie 46	Terminales Serie 48	DN	Pulg.	Tamaño	mm	UNF	mm	mm	mm	mm
1J146-4-4	1J148-4-4	6	1/4	-4	6,4	9/16x18	58	35	46	17
	1J148-6-4	6	1/4	-4	6,4	11/16x16	59	36	54	22
1J146-6-6	1J148-6-6	10	3/8	-6	9,5	11/16x16	58	35	54	22
1J146-8-6	1J148-8-6	10	3/8	-6	9,5	13/16x16	59	37	64	24
1J146-8-8	1J148-8-8	12	1/2	-8	12,7	13/16x16	61	37	64	24
	1J148-10-8	12	1/2	-8	12,7	1x14	66	42	70	30
1J146-10-10	1J148-10-10	16	5/8	-10	15,9	1x14	65	39	70	30
1J146-12-12	1J148-12-12	19	3/4	-12	19,1	1 3/16x12	80	54	96	36
	1J148-16-16	25	1	-16	25,4	1 7/16x12	98	68	114	41

J5 Hembra giratoria ORFS Codo 90° - Medio

ISO 12151-1 – SWEM – ORFS 90° M

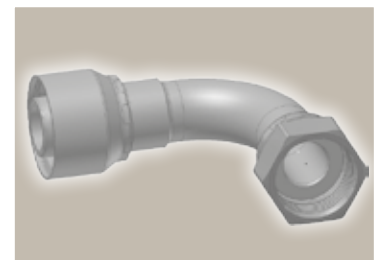
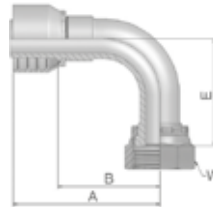

Referencia		D.I. de manguera				Rosca	A	B	E	W
Terminales Serie 46	Terminales Serie 48	DN	Pulg.	Tamaño	mm	UNF	mm	mm	mm	mm
1J546-4-4	1J548-4-4	6	1/4	-4	6,4	9/16x18	59	35	32	17
1J546-6-4	1J548-6-4	6	1/4	-4	6,4	11/16x16	62	39	38	22
1J546-6-6	1J548-6-6	10	3/8	-6	9,5	11/16x16	58	35	38	22
1J546-8-6	1J548-8-6	10	3/8	-6	9,5	13/16x16	60	37	41	24
1J546-8-8	1J548-8-8	12	1/2	-8	12,7	13/16x16	60	37	41	24

Disponible también en acero inoxidable.

Serie de terminales aprobados para tipos de manguera, dependiendo del tamaño:

46	o	48	441	441RH	461LT	462	462ST	462TC	462ST	629PU	692PU Twin						
46	463	492	492ST	492TC	692	692Twin	692TC	BCH1									
48	301SN	301TC	304	387	387ST	387TC	421RH	421SN	426	436	441RH	462PU	462PU Twin	BCH2	HT2	...	
	471TC	477	477ST	477TC	477RH	487	487ST	487TC	493	787	787TC	787ST	797	797TC	797ST	811	881

JM Macho ORFS

ISO 12151-1-S – SAE J516

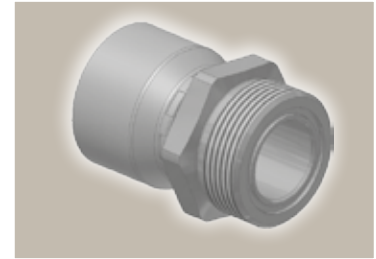
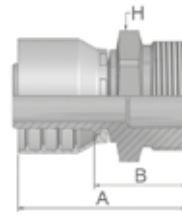

Referencia		D.I. de manguera				Rosca	A	B	H
Terminales Serie 46	Terminales Serie 48	DN	Pulg.	Tamaño	mm	UNF	mm	mm	mm
1JM46-4-4		6	1/4	-4	6,4	9/16x18	46	22	17
	1JM48-4-4	6	1/4	-4	6,4	9/16x18	44	22	17
1JM46-6-4		6	1/4	-4	6,4	11/16x16	48	24	19
	1JM48-6-4	6	1/4	-4	6,4	11/16x16	46	24	19
1JM46-6-5	1JM48-6-5	8	5/16	-5	7,9	11/16x16	53	26	19
1JM46-6-6	1JM48-6-6	10	3/8	-6	9,5	11/16x16	47	24	19
1JM46-8-6	1JM48-8-6	10	3/8	-6	9,5	13/16x16	50	27	22
1JM46-8-8	1JM48-8-8	12	1/2	-8	12,7	13/16x16	51	27	22
1JM46-10-8	1JM48-10-8	12	1/2	-8	12,7	1x14	55	32	27
1JM46-10-10	1JM48-10-10	16	5/8	-10	15,9	1x14	57	32	27
1JM46-12-10	1JM48-12-10	16	5/8	-10	15,9	1 3/16x12	59	34	32
1JM46-12-12	1JM48-12-12	19	3/4	-12	19,1	1 3/16x12	60	34	32
1JM46-16-12	1JM48-16-12	19	3/4	-12	19,1	1 7/16x12	64	38	41
1JM46-16-16	1JM48-16-16	25	1	-16	25,4	1 7/16x12	67	37	41
1JM46-20-16	1JM48-20-16	25	1	-16	25,4	1 11/16x12	66	36	46
	1JM48-20-20	31	1 1/4	-20	31,8	1 11/16x12	85	37	46

Vea sección Eb para elegir la junta correspondiente.

JD Macho ORFS

Pasatabiques con contratuerca

Recto (con junta tórica)

ISO 12151-1 – SAE J516

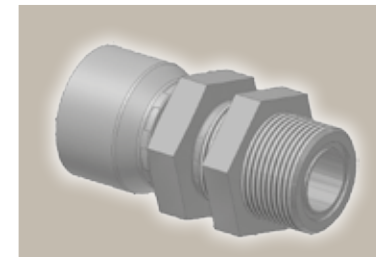
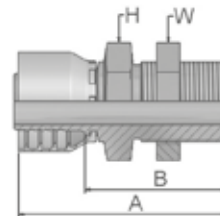

Referencia		D.I. de manguera				Rosca	A	B	H	W
Terminales Serie 46	Terminales Serie 48	DN	Pulg.	Tamaño	mm	UNF	mm	mm	mm	mm
1JD46-4-4	1JD48-4-4	6	1/4	-4	6,4	9/16x18	72	48	22	22
1JD46-6-6	1JD48-6-6	10	3/8	-6	9,5	11/16x16	73	51	27	27
1JD46-8-8	1JD48-8-8	12	1/2	-8	12,7	13/16x16	79	56	30	30
1JD46-10-10	1JD48-10-10	16	5/8	-10	15,9	1x14	86	60	32	36
1JD46-12-12	1JD48-12-12	19	3/4	-12	19,1	1 3/16x12	88	63	36	38
	1JD48-16-16	25	1	-16	25,4	1 7/16x12	94	64	46	46

Disponible también en acero inoxidable.

Serie de terminales aprobados para tipos de manguera, dependiendo del tamaño:

46	o	48	441	441RH	461LT	462	462ST	462TC	462ST	629PU	692PU Twin						
46	463	492	492ST	492TC	692	692Twin	692TC	BCH1									
48	301SN	301TC	304	387	387ST	387TC	421RH	421SN	426	436	441RH	462PU	462PU Twin	BCH2	HT2	...	
	471TC	477	477ST	477TC	477RH	487	487ST	487TC	493	787	787TC	787ST	797	797TC	797ST	811	881

**FU Hembra giratoria BSP
Cilíndrica
Recta (Abocardado 30°)**
ISO 228-1 – JIS B8363 – GUI

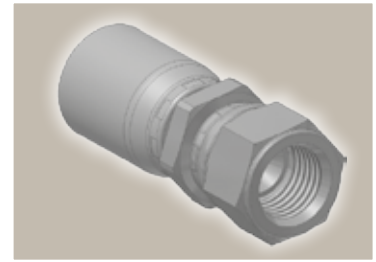
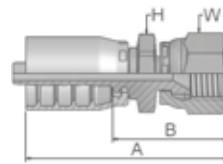

Referencia		D.I. de manguera				Rosca	A	B	H	W
Terminales Serie 46	Terminales Serie 48	DN	Pulg.	Tamaño	mm	BSP	mm	mm	mm	mm
1FU46-4-4	1FU48-4-4	6	1/4	-4	6,4	1/4x19	50	32	19	19
1FU46-6-6	1FU48-6-6	10	3/8	-6	9,5	3/8x19	58	35	24	22
1FU46-12-12	1FU48-12-12	19	3/4	-12	19,1	3/4x14	71	45	36	36
1FU46-16-16	1FU48-16-16	25	1	-16	25,4	1x11	76	46	41	41

**GU Hembra giratoria BSP
Cilíndrica (Codo 60°)**
ISO 228-1 – JIS B8363 – GUO

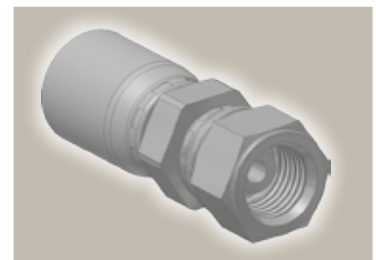
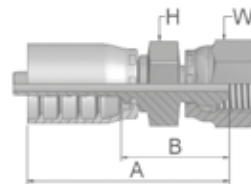

Referencia		D.I. de manguera				Rosca	A	B	H	W
Terminales Serie 46	Terminales Serie 48	DN	Pulg.	Tamaño	mm	BSP	mm	mm	mm	mm
1GU46-4-4	1GU48-4-4	6	1/4	-4	6,4	1/4x19	55	33	19	19
1GU46-6-6	1GU48-6-6	10	3/8	-6	9,5	3/8x19	58	35	22	22
1GU46-8-8	1GU48-8-8	12	1/2	-8	12,7	1/2x14	55	32	27	27

Disponible también en acero inoxidable.

Serie de terminales aprobados para tipos de manguera, dependiendo del tamaño:

46	o	48	441	441RH	461LT	462	462ST	462TC	462ST	629PU	692PU Twin						
46	463	492	492ST	492TC	692	692Twin	692TC	BCH1									
48	301SN	301TC	304	387	387ST	387TC	421RH	421SN	426	436	441RH	462PU	462PU Twin	BCH2	HT2	...	
	471TC	477	477ST	477TC	477RH	487	487ST	487TC	493	787	787TC	787ST	797	797TC	797ST	811	881

MU Hembra giratoria métrica Recta (Abocardado 30°)

JIS B8363 – MU

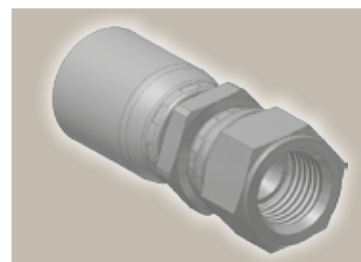
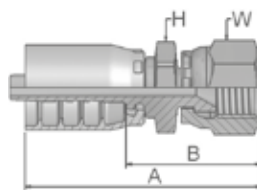

Referencia		D.I. de manguera				Rosca métrica	A mm	B mm	H mm	W mm
Terminales Serie 46	Terminales Serie 48	DN	Pulg.	Tamaño	mm					
1MU46-4-4	1MU48-4-4	6	1/4	-4	6,4	M14x1,5	45	21	19	19
	1MU48-6-4	6	1/4	-4	6,4	M18x1,5	57	33	24	24
1MU46-6-6	1MU48-6-6	10	3/8	-6	9,5	M18x1,5	59	36	24	24
1MU46-8-8	1MU48-8-8	12	1/2	-8	12,7	M22x1,5	64	40	27	27

MZ Hembra giratoria métrica Codo 90° (Abocardado 30°)

JIS B8363

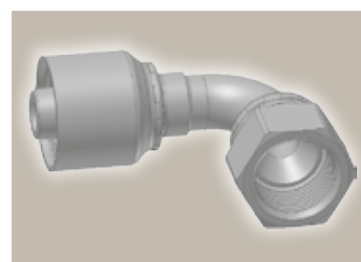
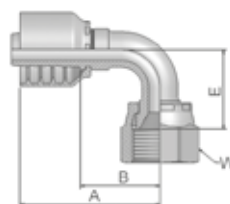

Referencia		D.I. de manguera				Rosca métrica	A mm	B mm	E mm	W mm
Terminales Serie 46	Terminales Serie 48	DN	Pulg.	Tamaño	mm					
1MZ46-4-4	1MZ48-4-4	6	1/4	-4	6,4	M14x1,5	48	24	23	19
1MZ46-6-6	1MZ48-6-6	10	3/8	-6	9,5	M18x1,5	51	28	29	24
1MZ46-8-8	1MZ48-8-8	12	1/2	-8	12,7	M22x1,5	55	31	31	27

Serie de terminales aprobados para tipos de manguera, dependiendo del tamaño:

Disponible también en acero inoxidable.

46	o	48	441	441RH	461LT	462	462ST	462TC	462ST	629PU	692PU Twin						
46	463	492	492ST	492TC	692	692Twin	692TC	BCH1									
48	301SN	301TC	304	387	387ST	387TC	421RH	421SN	426	436	441RH	462PU	462PU Twin	BCH2	HT2	...	
	471TC	477	477ST	477TC	477RH	487	487ST	487TC	493	787	787TC	787ST	797	797TC	797ST	811	881

FG Macho Gaz francés Rígido Recto (Cono 24°)

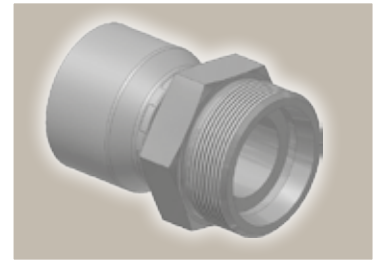
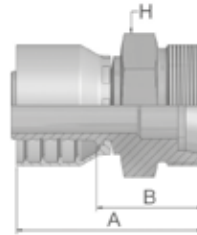

Referencia		D.I. de manguera				Rosca métrica	Tubo D.E.	A	B	H
Terminales Serie 46	Terminales Serie 48	DN	Pulg.	Tamaño	mm		mm	mm	mm	mm
1FG46-13-5	1FG48-13-5	8	5/16	-5	7,9	M20x1,5	13	53	29	22
1FG46-13-6	1FG48-13-6	10	3/8	-6	9,5	M20x1,5	13	52	29	22
1FG46-17-8	1FG48-17-8	12	1/2	-8	12,7	M24x1,5	17	51	27	24
1FG46-21-10	1FG48-21-10	16	5/8	-10	15,9	M30x1,5	21	57	32	30
1FG46-27-12	1FG48-27-12	19	3/4	-12	19,1	M36x1,5	27	59	34	36
1FG46-33-16	1FG48-33-16	25	1	-16	25,4	M45x1,5	33	69	40	46

F2 Hembra giratoria francesa Serie Gaz Codo 90°

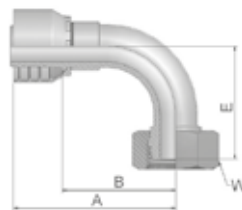

Referencia		D.I. de manguera				Rosca métrica	Tubo D.E.	A	B	E	W
Terminales Serie 46	Terminales Serie 48	DN	Pulg.	Tamaño	mm		mm	mm	mm	mm	mm
1F246-13-5	1F248-13-5	8	5/16	-5	7,9	M20x1,5	13	59	35	30	24
1F246-13-6	1F248-13-6	10	3/8	-6	9,5	M20x1,5	13	60	38	33	24
1F246-17-8	1F248-17-8	12	1/2	-8	12,7	M24x1,5	17	63	39	43	30
1F246-21-10	1F248-21-10	16	5/8	-10	15,9	M30x1,5	21	71	46	45	36

Serie de terminales aprobados para tipos de manguera, dependiendo del tamaño:

Disponible también en acero inoxidable.

46	o	48	441	441RH	461LT	462	462ST	462TC	462ST	629PU	692PU Twin						
46	463	492	492ST	492TC	692	692Twin	692TC	BCH1									
48	301SN	301TC	304	387	387ST	387TC	421RH	421SN	426	436	441RH	462PU	462PU Twin	BCH2	HT2	...	
	471TC	477	477ST	477TC	477RH	487	487ST	487TC	493	787	787TC	787ST	797	797TC	797ST	811	881

F4 Hembra giratoria francesa Serie Gaz Recta (Asiento ovalado)

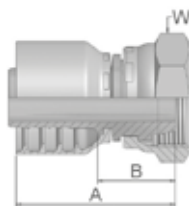

Referencia		D.I. de manguera				Rosca	Tubo	A	B	W
Terminales Serie 46	Terminales Serie 48	DN	Pulg.	Tamaño	mm	métrica	D.E. mm	mm	mm	mm
1F446-13-4	1F448-13-4	6	1/4	-4	6,4	M20x1,5	13	48	24	24
1F446-13-5	1F448-13-5	8	5/16	-5	7,9	M20x1,5	13	48	24	24
1F446-13-6	1F448-13-6	10	3/8	-6	9,5	M20x1,5	13	45	22	24
1F446-17-8	1F448-17-8	12	1/2	-8	12,7	M24x1,5	17	49	25	30
1F446-21-10	1F448-21-10	16	5/8	-10	15,9	M30x1,5	21	50	25	36
1F446-27-12	1F448-27-12	19	3/4	-12	19,1	M36x1,5	26	59	33	46
1F446-33-16	1F448-33-16	25	1	-16	25,4	M45x1,5	33	63	33	55

F6 Macho francés métrico (Cono 24°)

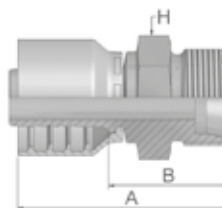

Referencia		D.I. de manguera				Rosca	Tubo	A	B	H
Terminales Serie 46	Terminales Serie 48	DN	Pulg.	Tamaño	mm	métrica	D.E. mm	mm	mm	mm
1F646-14-6	1F648-14-6	10	3/8	-6	9,5	M20x1,5	14	50	27	22
1F646-20-10	1F648-20-10	16	5/8	-10	15,9	M27x1,5	20	59	33	30

Serie de terminales aprobados para tipos de manguera, dependiendo del tamaño:

Disponible también en acero inoxidable.

46	o	48	441	441RH	461LT	462	462ST	462TC	462ST	629PU	692PU	Twin					
46	463	492	492ST	492TC	692	692Twin	692TC	BCH1									
48	301SN	301TC	304	387	387ST	387TC	421RH	421SN	426	436	441RH	462PU	462PU Twin	BCH2	HT2	...	
	471TC	477	477ST	477TC	477RH	487	487ST	487TC	493	787	787TC	787ST	797	797TC	797ST	811	881

F9 Hembras giratoria francesa métrica (Asiento ovalado)

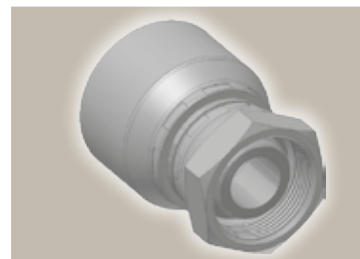
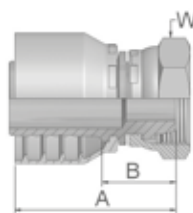

Referencia		D.I. de manguera				Rosca métrica	Tubo D.E.	A	B	W
Terminales Serie 46	Terminales Serie 48	DN	Pulg.	Tamaño	mm		mm	mm	mm	mm
1F946-6-4	1F948-6-4	6	1/4	-4	6,4	M12x1	6	43	20	14
1F946-10-4	1F948-10-4	6	1/4	-4	6,4	M16x1,5	10	45	22	19
1F946-14-6	1F948-14-6	10	3/8	-6	9,5	M20x1,5	14	44	22	24
1F946-20-10	1F948-20-10	16	5/8	-10	15,9	M27x1,5	20	50	25	32
1F946-22-12	1F948-22-12	19	3/4	-12	19,1	M30x1,5	22	53	27	36
1F946-25-12	1F948-25-12	19	3/4	-12	19,1	M33x1,5	25	55	29	41
1F946-30-16	1F948-30-16	25	1	-16	25,4	M39x1,5	30	61	32	50

FA Macho métrico para válvulas agrícolas

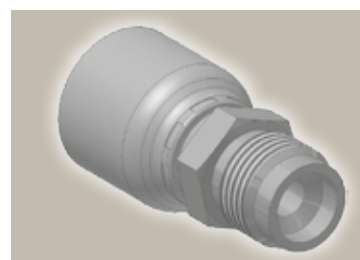
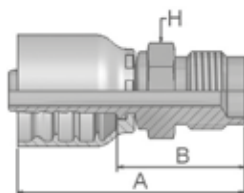

Referencia		D.I. de manguera				Rosca métrica	A	B	H
Terminales Serie 46	Terminales Serie 48	DN	Pulg.	Tamaño	mm		mm	mm	mm
1FA46-12-5	1FA48-12-5	8	5/16	-5	7,9	M18x1,5	53	29	19
1FA46-12-6	1FA48-12-6	10	3/8	-6	9,5	M18x1,5	52	30	19
1FA46-12-8	1FA48-12-8	12	1/2	-8	12,7	M18x1,5	53	30	19

Disponible también en acero inoxidable.

Serie de terminales aprobados para tipos de manguera, dependiendo del tamaño:

46	o	48	441	441RH	461LT	462	462ST	462TC	462ST	629PU	692PU Twin						
46	463	492	492ST	492TC	692	692Twin	692TC	BCH1									
48	301SN	301TC	304	387	387ST	387TC	421RH	421SN	426	436	441RH	462PU	462PU Twin	BCH2	HT2	...	
	471TC	477	477ST	477TC	477RH	487	487ST	487TC	493	787	787TC	787ST	797	797TC	797ST	811	881

CW Conexión Power Cleaner

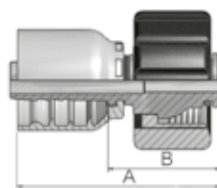

Referencia		D.I. de manguera				Rosca métrica	Tubo D.E.	A	B
Terminales Serie 46	Terminales Serie 48	DN	Pulg.	Tamaño	mm		mm	mm	mm
1CW46-15-4	1CW48-15-4	6	1/4	-4	6,4	M22x1,5	15	53	29
1CW46-15-5	1CW48-15-5	8	5/16	-5	7,9	M22x1,5	15	53	29
1CW46-15-6	1CW48-15-6	10	3/8	-6	9,5	M22x1,5	15	52	29
1CW46-15-8	1CW48-15-8	12	1/2	-8	12,7	M22x1,5	15	53	29

Funda de goma referencia WKS-X-XXX en negro o azul, por favor vea Eb-20.

NW Terminal de limpieza hembra giratoria métrica Kärcher Recta

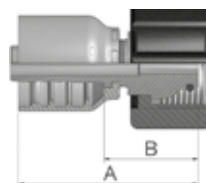

Referencia		D.I. de manguera				Rosca métrica	A	B
Terminales Serie 46	Terminales Serie 48	DN	Pulg.	Tamaño	mm		mm	mm
1NW46-15-4	1NW48-15-4	6	1/4	-4	6,4	M22x1,5	52	29
1NW46-15-5	1NW48-15-5	8	5/16	-5	7,9	M22x1,5	52	29
1NW46-15-6	1NW48-15-6	10	3/8	-6	9,5	M22x1,5	48	25

Funda de goma referencia WKS-X-XXX en negro o azul, por favor vea Eb-20.

Serie de terminales aprobados para tipos de manguera, dependiendo del tamaño:

Disponible también en acero inoxidable.

46	o	48	441	441RH	461LT	462	462ST	462TC	462ST	629PU	692PU Twin						
46	463	492	492ST	492TC	692	692Twin	692TC	BCH1									
48	301SN	301TC	304	387	387ST	387TC	421RH	421SN	426	436	441RH	462PU	462PU Twin	BCH2	HT2	...	
	471TC	477	477ST	477TC	477RH	487	487ST	487TC	493	787	787TC	787ST	797	797TC	797ST	811	881

PW Terminal de limpieza macho giratorio métrico rígido Kärcher – Recto

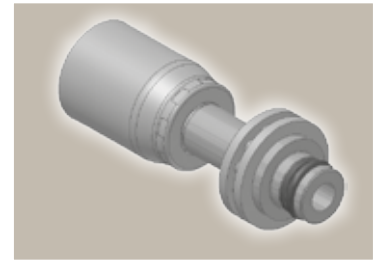
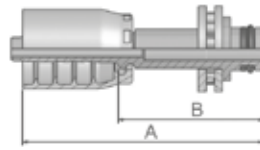

Referencia		D.I. de manguera				Tubo	A	B
Terminales Serie 46	Terminales Serie 48	DN	Pulg.	Tamaño	mm	D.E. mm	mm	mm
1PW46-10-4	1PW48-10-4	6	1/4	-4	6,4	10	60	36
1PW46-11-4	1PW48-11-4	6	1/4	-4	6,4	11	60	37
1PW46-10-5	1PW48-10-5	8	5/16	-5	7,9	10	60	36
1PW46-11-5	1PW48-11-5	8	5/16	-5	7,9	11	61	37
1PW46-10-6	1PW48-10-6	10	3/8	-6	9,5	10	60	37

Funda de goma referencia WKS-X-XXX en negro o azul, por favor vea Eb-20.

1PWxx-11-x = with ball bearing as shown above

1PWxx-10-x = without ball bearing

Disponible también en acero inoxidable.

Serie de terminales aprobados para tipos de manguera, dependiendo del tamaño:

46	o	48	441	441RH	461LT	462	462ST	462TC	462ST	629PU	692PU Twin						
46	463	492	492ST	492TC	692	692Twin	692TC	BCH1									
48	301SN	301TC	304	387	387ST	387TC	421RH	421SN	426	436	441RH	462PU	462PU Twin	BCH2	HT2	...	
	471TC	477	477ST	477TC	477RH	487	487ST	487TC	493	787	787TC	787ST	797	797TC	797ST	811	881

XU Hembra giratoria métrica Recta (Abocardado 30°)

JIS B8363

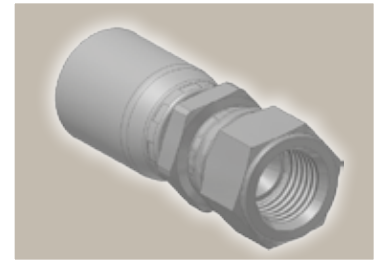
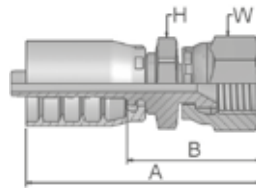

Referencia		D.I. de manguera				Rosca métrica	A	B	H	W
Terminales Serie 46	Terminales Serie 48	DN	Pulg.	Tamaño	mm		mm	mm	mm	mm
	1XU48-10-10	16	5/8	-10	15,9	M24x1,5	69	44	30	32
	1XU48-12-12	19	3/4	-12	19,1	M30x1,5	73	47	32	36

DK Macho métrico L rígido Pasatabiques con con- tratuera (Cono 24°)

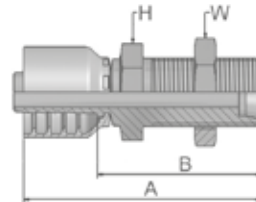

Referencia		D.I. de manguera				Rosca métrica	A	B	H	W
Terminales Serie 46	Terminales Serie 48	DN	Pulg.	Tamaño	mm		mm	mm	mm	mm
1DK46-10-5	1DK48-10-5	8	5/16	-5	7,9	M16x1,5	71	48	22	22
1DK46-15-10	1DK48-15-10	16	5/8	-10	15,9	M22x1,5	81	56	27	30
1DK46-18-10		16	5/8	-10	15,9	M26x1,5	85	60	32	36
	1DK48-18-10	16	5/8	-10	15,9	M26x1,5	85	60	36	36



Serie de terminales aprobados para tipos de manguera, dependiendo del tamaño:

Disponible también en acero inoxidable.

46	o	48	441	441RH	461LT	462	462ST	462TC	462ST	629PU	692PU Twin						
46	463	492	492ST	492TC	692	692Twin	692TC	BCH1									
48	301SN	301TC	304	387	387ST	387TC	421RH	421SN	426	436	441RH	462PU	462PU Twin	BCH2	HT2	...	
	471TC	477	477ST	477TC	477RH	487	487ST	487TC	493	787	787TC	787ST	797	797TC	797ST	811	881

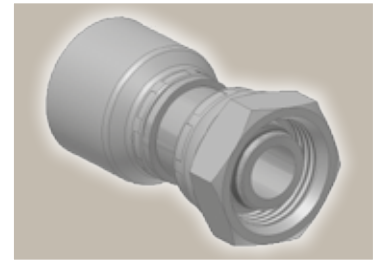
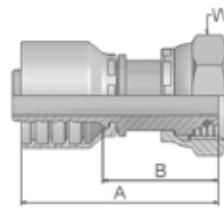
DX Hembra giratoria métrica (M27x2) con tórica - Serie ligera



Referencia		 D.I. de manguera				 Rosca métrica	A	B	 W
Terminales Serie 46	Terminales Serie 48	DN	Pulg.	Tamaño	mm		mm	mm	mm
1DX46-18-10	1DX48-18-10	16	5/8	-10	15,9	M27x2	61	36	32

Serie de terminales aprobados para **tipos de manguera**, dependiendo del tamaño:

Disponible también en acero inoxidable.

46 o 48	441	441RH	461LT	462	462ST	462TC	462ST	629PU	692PU Twin								
46	463	492	492ST	492TC	692	692Twin	692TC	BCH1									
48	301SN	301TC	304	387	387ST	387TC	421RH	421SN	426	436	441RH	462PU	462PU Twin	BCH2	HT2	...	
	471TC	477	477ST	477TC	477RH	487	487ST	487TC	493	787	787TC	787ST	797	797TC	797ST	811	881

**EN UPTC
Recta**

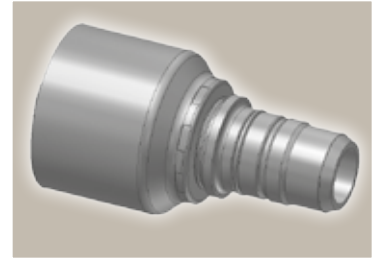
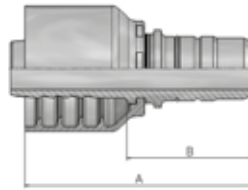

Referencia		D.I. de manguera				Tubo	A	B
Terminales Serie 46	Terminales Serie 48	DN	Pulg.	Tamaño	mm	D.E. mm	mm	mm
1EN46-8-4	1EN48-8-4	6	1/4	-4	6,4	8	49	26
1EN46-10-5	1EN48-10-5	8	5/16	-5	7,9	10	50	26
1EN46-12-6	1EN48-12-6	10	3/8	-6	9,5	12	50	27
1EN46-15-8	1EN48-15-8	12	1/2	-8	12,7	15	53	29
1EN46-18-10	1EN48-18-10	16	5/8	-10	15,9	18	56	31
1EN46-22-12	1EN48-22-12	19	3/4	-12	19,1	22	57	32

**EU UPTC
Codo 45°**

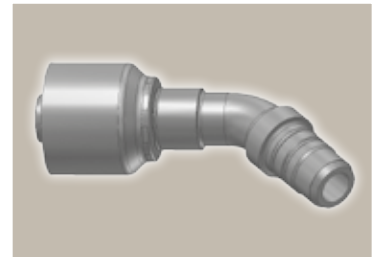
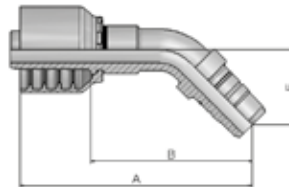

Referencia		D.I. de manguera				Tubo	A	B	E
Terminales Serie 46	Terminales Serie 48	DN	Pulg.	Tamaño	mm	D.E. mm	mm	mm	mm
1EU46-8-4	1EU48-8-4	6	1/4	-4	6,4	8	66	43	23
1EU46-10-5	1EU48-10-5	8	5/16	-5	7,9	10	68	45	23
1EU46-12-6	1EU48-12-6	10	3/8	-6	9,5	12	71	48	23
1EU46-15-8	1EU48-15-8	12	1/2	-8	12,7	15	78	54	25
1EU46-18-10	1EU48-18-10	16	5/8	-10	15,9	18	84	59	32
1EU46-22-12	1EU48-22-12	19	3/4	-12	19,1	22	95	69	33

Disponible también en acero inoxidable.

Serie de terminales aprobados para tipos de manguera, dependiendo del tamaño:

46	o	48	441	441RH	461LT	462	462ST	462TC	462ST	629PU	692PU	Twin					
46	463	492	492ST	492TC	692	692Twin	692TC	BCH1									
48	301SN	301TC	304	387	387ST	387TC	421RH	421SN	426	436	441RH	462PU	462PU Twin	BCH2	HT2	...	
	471TC	477	477ST	477TC	477RH	487	487ST	487TC	493	787	787TC	787ST	797	797TC	797ST	811	881

ET UPTC
Codo 90°

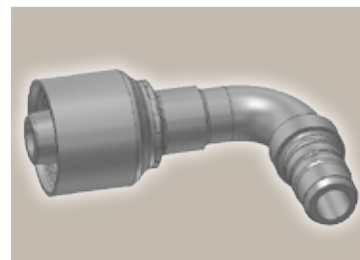
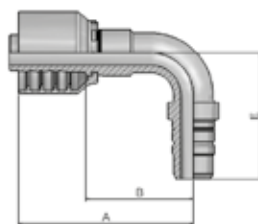

Referencia		 D.I. de manguera				Tubo	A	B	E
Terminales Serie 46	Terminales Serie 48	DN	Pulg.	Tamaño	mm	D.E. mm	mm	mm	mm
1ET46-8-4	1ET48-8-4	6	1/4	-4	6,4	8	59	36	39
1ET46-10-5	1ET48-10-5	8	5/16	-5	7,9	10	58	35	39
1ET46-12-6	1ET48-12-6	10	3/8	-6	9,5	12	57	34	40
1ET46-15-8	1ET48-15-8	12	1/2	-8	12,7	15	61	38	45
1ET46-18-10	1ET48-18-10	16	5/8	-10	15,9	18	65	39	57
1ET46-22-12	1ET48-22-12	19	3/4	-12	19,1	22	80	54	64

Serie de terminales aprobados para **tipos de manguera**, dependiendo del tamaño:

Disponible también en acero inoxidable.

46	o	48	441	441RH	461LT	462	462ST	462TC	462ST	629PU	692PU Twin						
46	463	492	492ST	492TC	692	692Twin	692TC	BCH1									
48	301SN	301TC	304	387	387ST	387TC	421RH	421SN	426	436	441RH	462PU	462PU Twin	BCH2	HT2	...	
	471TC	477	477ST	477TC	477RH	487	487ST	487TC	493	787	787TC	787ST	797	797TC	797ST	811	881

RACORES SERIE 70







DIN – Métrica

Página Db-1 – Db-4

<p>CA Db-1 Hembra giratoria métrica 24° Serie ligera con junta tórica Recta ISO 12151-2-SWS-L – DKOL</p> 	<p>CE Db-1 Hembra giratoria métrica 24° Serie ligera con junta tórica Codo 45° ISO 12151-2-SWE 45°-L – DKOL 45°</p> 	<p>CF Db-2 Hembra giratoria métrica 24° Serie ligera con junta tórica Codo 90° ISO 12151-2-SWE-L – DKOL 90°</p> 	<p>D0 Db-2 Macho métrico recto 24° Serie ligera – Recta ISO 12151-2-S-L – CEL</p> 
<p>C9 Db-3 Hembra giratoria métrica 24° Serie pesada con junta tórica Recta ISO 12151-2-SWS-S – DKOS</p> 	<p>OC Db-3 Hembra giratoria métrica 24° Serie pesada con junta tórica Codo 45° ISO 12151-2 – SWE 45°-S – DKOS 45°</p> 	<p>1C Db-4 Hembra giratoria métrica 24° Serie pesada con junta tórica Codo 90° ISO 12151-2-SWE-S – DKOS 90°</p> 	<p>D2 Db-4 Macho métrico recto 24° Serie pesada Rígido ISO 12151-2-S-S – CES</p> 



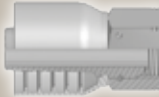

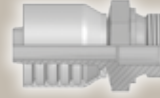
BSP

Página Db-5 – Db-7

<p>92 Db-5 Hembra giratoria BSP (Asiento 60°) BS5200-A – DKR</p> 	<p>B1 Db-5 Hembra giratoria BSP cónica Codo 45° (Cono 60°) BS 5200-D – DKR 45°</p> 	<p>B2 Db-6 Hembra giratoria BSP Cilíndrica Codo 90° (Asiento 60°) BS 5200-B – DKR 90°</p> 	<p>EA Db-6 Hembra giratoria BSP con junta tórica (Cono 60°) BS 5200 – ISO 12151-6 – DKOR</p> 
<p>EC Db-7 Hembra giratoria BSP con junta tórica Codo 90° (Cono 60°) BS 5200 – ISO 12151-6 – DKOR 90°</p> 	<p>D9 Db-7 Macho cilíndrico BSP Rígido – Recto (Cono 60°) BS5200 – AGR</p> 		

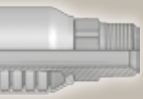

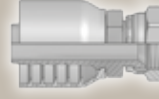
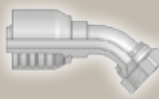



SAE

Página Db-8 – Db-10

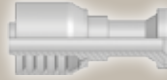
<p>01 Db-8 Macho NPTF fijo Rígido – Recto SAE J476A / J516 – AGN</p> 	<p>03 Db-8 Macho JIC 37° Rígido – Recto ISO12151-5-S – AGJ</p> 	<p>06 Db-9 Hembra giratoria JIC 37° Recta ISO12151-5-SWS – DKJ</p> 	<p>37 Db-10 Hembra giratoria JIC 37° Codo 45° ISO 12151-5-SWE 45° – DKJ 45°</p> 
<p>39/3W Db-10 Hembra giratoria doble Asiento JIC 37° / SAE 45° Codo 90° ISO 12151-5-SWES – DKJ 90°</p> 			

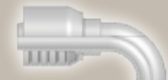

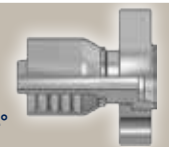

Bridas

Página Db-11 – Db-14

<p>15 Db-11 Brida ISO 6162-1 Recta ISO 12151-3-S-L – SFL (21,0 MPa/ 3000 psi)</p> 	<p>17 Db-11 Brida ISO 6162-1 Codo 45° ISO 12151-3 – E45 – L – SFL 45° (35,0 MPa/ 5000 psi)</p> 	<p>19 Db-12 Brida ISO 6162-1 Codo 90° ISO 12151-3 – E – L – SFL 90° (21,0 MPa/ 3000 psi)</p> 	<p>6A Db-12 Brida ISO 6162-2 Recta ISO 12151-3-S-S – SFS (42,0 MPa/ 6000 psi)</p> 
<p>6F Db-13 Brida ISO 6162-2 Codo 45° ISO 12151-3 – E45-S – SFS 45° (42,0 MPa/ 6000 psi)</p> 	<p>6N Db-13 Brida ISO 6162-2 Codo 90° ISO 12151-3 – E-S – SFS 90° (42,0 MPa/ 6000 psi)</p> 	<p>PY Db-14 Brida – Macho 24° Gas Francés Recta</p> 	

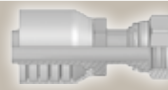
ORFS

Página Db-15 – Db-17

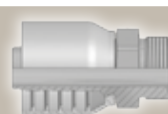
<p>JC Db-15 Hembra giratoria ORFS Recta – Corta ISO 12151-1 – SWSA SAE J516 – ORFS</p> 	<p>JS Db-15 Hembra giratoria ORFS (Larga) ISO 12151-1-SWSB SAE J516 – ORFS</p> 	<p>J7 Db-16 Hembra giratoria ORFS Codo 45° ISO 12151-1 – SWE 45° SAE J516 – ORFS 45°</p> 	<p>J9 Db-16 Hembra giratoria ORFS Codo 90° – Corto ISO 12151-1 – SWES SAE J516 – ORFS 90°</p> 
<p>J1 Db-17 Hembra giratoria ORFS Codo 90° – Largo ISO 12151-1 – SWEL SAE J516 – ORFS 90° L</p> 	<p>JM Db-17 Macho ORFS ISO 12151-1-S – SAE J516</p> 		

JIS

Página Db-18

MU
Db-18
Hembra giratoria métrica Recta (Abocardado 30°)
JIS B8363 – MU

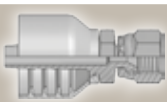

Estándar Francés

Página Db-19

<p>FG Db-19 Macho Gaz francés Rígido Recto (Cono 24°)</p> 	<p>F4 Db-19 Hembra giratoria francesa Serie Gaz Recta (Asiento ovalado)</p> 
--	---

Otros

Página Db-20

<p>XU Db-20 Hembra giratoria métrica Recta (Abocardado 30°) JIS B8363</p> 	<p>XY Db-20 Hembra giratoria métrica Codo 90° (Abocardado 30°) JIS B8363</p> 
---	--

CA Hembra giratoria métrica 24° Serie ligera con junta tórica Recta

ISO 12151-2-SWS-L – DKOL

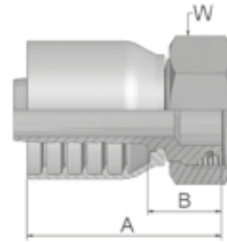

Referencia	D.I. de manguera				Rosca métrica	Tubo D.E. mm	A mm	B mm	W mm
	DN	Pulg.	Tamaño	mm					
1CA70-10-6	10	3/8	-6	9,5	M16x1,5	10	53	24	19
1CA70-12-6	10	3/8	-6	9,5	M18x1,5	12	53	24	22
1CA70-15-8	12	1/2	-8	12,7	M22x1,5	15	62	27	27
1CA70-18-8	12	1/2	-8	12,7	M26x1,5	18	57	22	32
1CA70-15-10	16	5/8	-10	15,9	M22x1,5	15	66	27	27
1CA70-18-10	16	5/8	-10	15,9	M26x1,5	18	62	25	32
1CA70-22-10	16	5/8	-10	15,9	M30x2	22	64	24	36
1CA70-18-12	19	3/4	-12	19,1	M26x1,5	18	65	26	32
1CA70-22-12	19	3/4	-12	19,1	M30x2	22	63	24	36
1CA70-28-12	19	3/4	-12	19,1	M36x2	28	66	26	41
1CA70-28-16	25	1	-16	25,4	M36x2	28	78	33	41
1CA70-35-16	25	1	-16	25,4	M45x2	35	76	31	50

Se pueden usar terminales con junta tórica estándar para temperaturas desde -40 °C hasta +105 °C.

CE Hembra giratoria métrica 24° Serie ligera con junta tórica Codo 45°

ISO 12151-2-SWE 45°-L – DKOL 45°

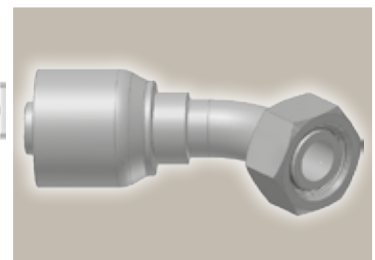
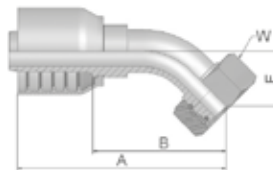

Referencia	D.I. de manguera				Rosca métrica	Tubo D.E. mm	A mm	B mm	E mm	W mm
	DN	Pulg.	Tamaño	mm						
1CE70-12-6	10	3/8	-6	9,5	M18x1,5	12	69	40	20	22
1CE70-15-8	12	1/2	-8	12,7	M22x1,5	15	85	50	23	27
1CE70-18-10	16	5/8	-10	15,9	M26x1,5	18	89	49	23	32
1CE70-22-12	19	3/4	-12	19,1	M30x2	22	98	58	26	36
1CE70-28-16	25	1	-16	25,4	M36x2	28	127	80	34	41

Se pueden usar terminales con junta tórica estándar para temperaturas desde -40 °C hasta +105 °C.

Serie de terminales aprobados para **tipos de manguera**, dependiendo del tamaño:

70 | 371LT | 372 | 372RH | 372TC | 701 | 701 TC | F42-8 | SX35

CF Hembra giratoria métrica 24° Serie ligera con junta tórica Codo 90°

ISO 12151-2-SWE-L – DKOL 90°

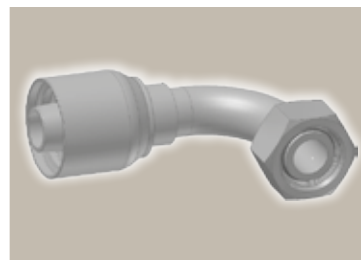
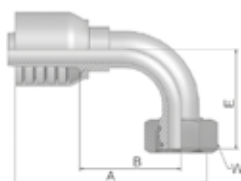

Referencia	D.I. de manguera				Rosca métrica	Tubo D.E. mm	A mm	B mm	E mm	W mm
	DN	Pulg.	Tamaño	mm						
1CF70-10-6	10	3/8	-6	9,5	M16x1,5	10	67	38	38	19
1CF70-12-6	10	3/8	-6	9,5	M18x1,5	12	67	38	37	22
1CF70-15-8	12	1/2	-8	12,7	M22x1,5	15	73	39	44	27
1CF70-18-8	12	1/2	-8	12,7	M26x1,5	18	71	36	40	32
1CF70-15-10	16	5/8	-10	15,9	M22x1,5	15	79	42	50	27
1CF70-18-10	16	5/8	-10	15,9	M26x1,5	18	79	42	49	32
1CF70-18-12	19	3/4	-12	19,1	M26x1,5	18	89	49	56	32
1CF70-22-12	19	3/4	-12	19,1	M30x2	22	89	49	55	36
1CF70-28-16	25	1	-16	25,4	M36x2	28	114	68	78	41
1CF70-35-16	25	1	-16	25,4	M45x2	35	115	68	69	50

Se pueden usar terminales con junta tórica estándar para temperaturas desde -40 °C hasta +105 °C.

DO Macho métrico recto 24° Serie ligera – Recta

ISO 12151-2-S-L – CEL

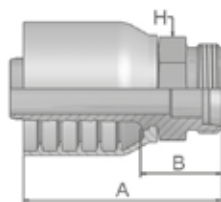

Referencia	D.I. de manguera				Rosca métrica	Tubo D.E. mm	A mm	B mm	H mm
	DN	Pulg.	Tamaño	mm					
1D070-15-8	12	1/2	-8	12,7	M22x1,5	15	60	26	22
1D070-18-10	16	5/8	-10	15,9	M26x1,5	18	65	28	27
1D070-22-12	19	3/4	-12	19,1	M30x2	22	69	30	30
1D070-28-16	25	1	-16	25,4	M36x2	28	79	32	36

Serie de terminales aprobados para **tipos de manguera**, dependiendo del tamaño:

70 | 371LT | 372 | 372RH | 372TC | 701 | 701 TC | F42-8 | SX35

C9 Hembra giratoria métrica 24° Serie pesada con junta tórica Recta

ISO 12151-2-SWS-S – DKOS

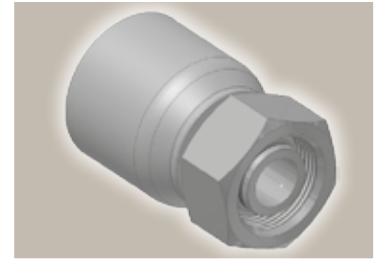
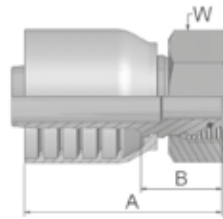

Referencia	D.I. de manguera				Rosca métrica	Tubo D.E. mm	A mm	B mm	W mm
	DN	Pulg.	Tamaño	mm					
1C970-8-6	10	3/8	-6	9,5	M16x1,5	8	53	24	19
1C970-12-6	10	3/8	-6	9,5	M20x1,5	12	52	22	24
1C970-14-6	10	3/8	-6	9,5	M22x1,5	14	53	24	27
1C970-12-8	12	1/2	-8	12,7	M20x1,5	12	60	25	24
1C970-16-8	12	1/2	-8	12,7	M24x1,5	16	59	24	30
1C970-20-8	12	1/2	-8	12,7	M30x2	20	59	24	36
1C970-16-10	16	5/8	-10	15,9	M24x1,5	16	66	27	30
1C970-20-10	16	5/8	-10	15,9	M30x2	20	64	27	36
1C970-25-10	16	5/8	-10	15,9	M36x2	25	65	29	46
1C970-20-12	19	3/4	-12	19,1	M30x2	20	66	27	36
1C970-25-12	19	3/4	-12	19,1	M36x2	25	68	28	46
1C970-25-16	25	1	-16	25,4	M36x2	25	78	33	46
1C970-30-16	25	1	-16	25,4	M42x2	30	80	33	50

Se pueden usar terminales con junta tórica estándar para temperaturas desde -40 °C hasta +105 °C.

OC Hembra giratoria métrica 24° Series pesada con junta tórica Codo 45°

ISO 12151-2 – SWE 45°-S – DKOS 45°

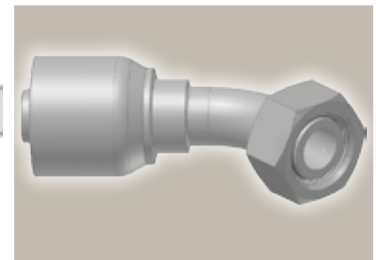
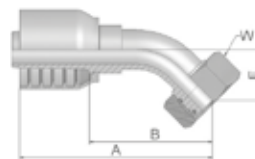

Referencia	D.I. de manguera				Rosca métrica	Tubo D.E. mm	A mm	B mm	E mm	W mm
	DN	Pulg.	Tamaño	mm						
10C70-12-6	10	3/8	-6	9,5	M20x1,5	12	69	40	20	24
10C70-14-6	10	3/8	-6	9,5	M22x1,5	14	76	46	20	27
10C70-16-8	12	1/2	-8	12,7	M24x1,5	16	83	48	24	30
10C70-16-10	16	5/8	-10	15,9	M24x1,5	16	88	49	22	30
10C70-20-10	16	5/8	-10	15,9	M30x2	20	91	51	25	36
10C70-25-10	16	5/8	-10	15,9	M36x2	25	92	56	27	46
10C70-20-12	19	3/4	-12	19,1	M30x2	20	99	60	28	36
10C70-25-12	19	3/4	-12	19,1	M36x2	25	100	61	29	46
10C70-25-16	25	1	-16	25,4	M36x2	25	123	76	33	46
10C70-30-16	25	1	-16	25,4	M42x2	30	126	79	36	50

Se pueden usar terminales con junta tórica estándar para temperaturas desde -40 °C hasta +105 °C.

Serie de terminales aprobados para tipos de manguera, dependiendo del tamaño:

70 371LT 372 372RH 372TC 701 701 TC F42-8 SX35

1C Hembra giratoria métrica 24° Serie pesada con junta tórica Codo 90°

ISO 12151-2-SWE-S – DKOS 90°

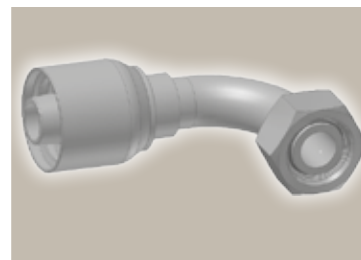
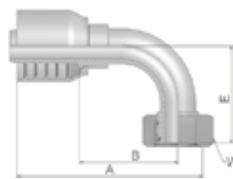

Referencia	D.I. de manguera				Rosca métrica	Tubo D.E. mm	A mm	B mm	E mm	W mm
	DN	Pulg.	Tamaño	mm						
11C70-8-6	10	3/8	-6	9,5	M16x1,5	8	67	38	37	19
11C70-12-6	10	3/8	-6	9,5	M20x1,5	12	67	38	37	24
11C70-14-6	10	3/8	-6	9,5	M22x1,5	14	64	35	37	27
11C70-16-8	12	1/2	-8	12,7	M24x1,5	16	72	37	45	30
11C70-20-8	12	1/2	-8	12,7	M30x2	20	75	40	46	36
11C70-16-10	16	5/8	-10	15,9	M24x1,5	16	79	40	45	30
11C70-20-10	16	5/8	-10	15,9	M30x2	20	79	40	48	36
11C70-25-10	16	5/8	-10	15,9	M36x2	25	85	46	52	46
11C70-20-12	19	3/4	-12	19,1	M30x2	20	89	50	58	36
11C70-25-12	19	3/4	-12	19,1	M36x2	25	89	49	59	46
11C70-30-12	19	3/4	-12	19,1	M42x2	30	89	50	60	50
11C70-25-16	25	1	-16	25,4	M36x2	25	109	64	69	46
11C70-30-16	25	1	-16	25,4	M42x2	30	115	68	76	50

Se pueden usar terminales con junta tórica estándar para temperaturas desde -40 °C hasta +105 °C.
Vea sección Eb para dimensiones y referencias de juntas. Disponibles a petición terminales con juntas tóricas especiales.

D2 Macho métrico recto 24° Serie pesada Rígido

ISO 12151-2-S-S – CES

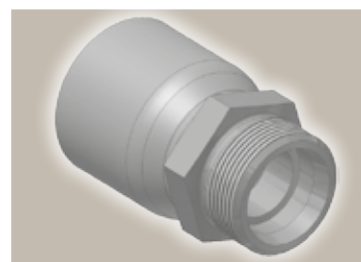
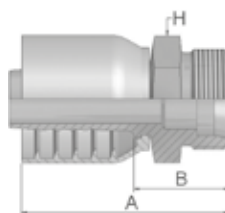

Referencia	D.I. de manguera				Rosca métrica	Tubo D.E. mm	A mm	B mm	H mm
	DN	Pulg.	Tamaño	mm					
1D270-12-6	10	3/8	-6	9,5	M20x1,5	12	53	24	22
1D270-14-6	10	3/8	-6	9,5	M22x1,5	14	55	25	22
1D270-16-8	12	1/2	-8	12,7	M24x1,5	16	62	28	24
1D270-20-8	12	1/2	-8	12,7	M30x2	20	67	32	30
1D270-20-10	16	5/8	-10	15,9	M30x2	20	75	32	30
1D270-20-12	19	3/4	-12	19,1	M30x2	20	72	33	30
1D270-25-12	19	3/4	-12	19,1	M36x2	25	74	35	36
1D270-25-16	25	1	-16	25,4	M36x2	25	84	37	36
1D270-30-16	25	1	-16	25,4	M42x2	30	85	40	46

Serie de terminales aprobados para **tipos de manguera**, dependiendo del tamaño:

70 | 371LT | 372 | 372RH | 372TC | 701 | 701 TC | F42-8 | SX35

92 Hembra giratoria BSP (Asiento 60°)

BS5200-A – DKR

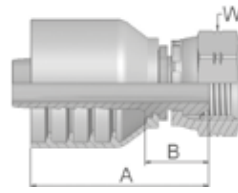

Referencia	D.I. de manguera				Rosca BSP	A mm	B mm	W mm
	DN	Pulg.	Tamaño	mm				
19270-6-6	10	3/8	-6	9,5	3/8x19	49	20	22
19270-8-6	10	3/8	-6	9,5	1/2x14	51	22	27
19270-8-8	12	1/2	-8	12,7	1/2x14	57	22	27
19270-10-8	12	1/2	-8	12,7	5/8x14	55	20	30
19270-10-10	16	5/8	-10	15,9	5/8x14	57	21	30
19270-12-10	16	5/8	-10	15,9	3/4x14	61	22	32
19270-12-12	19	3/4	-12	19,1	3/4x14	61	22	32
19270-16-12	19	3/4	-12	19,1	1x11	63	24	41
19270-16-16	25	1	-16	25,4	1x11	72	25	41

B1 Hembra giratoria BSP cónica Codo 45° (Cono 60°)

BS 5200-D – DKR 45°

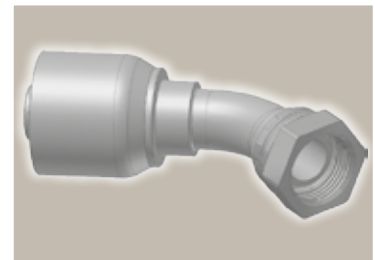
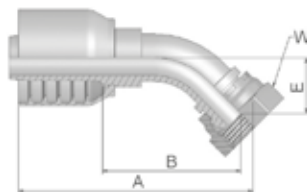

Referencia	D.I. de manguera				Rosca BSP	A mm	B mm	E mm	W mm
	DN	Pulg.	Tamaño	mm					
1B170-4-6	10	3/8	-6	9,5	1/4x19	68	39	19	19
1B170-6-6	10	3/8	-6	9,5	3/8x19	67	37	17	22
1B170-8-6	10	3/8	-6	9,5	1/2x14	68	39	19	27
1B170-8-8	12	1/2	-8	12,7	1/2x14	79	45	20	27
1B170-10-8	12	1/2	-8	12,7	5/8x14	78	43	19	30
1B170-10-10	16	5/8	-10	15,9	5/8x14	89	50	23	30
1B170-12-10	16	5/8	-10	15,9	3/4x14	88	49	22	32
1B170-12-12	19	3/4	-12	19,1	3/4x14	96	57	25	32
1B170-16-12	19	3/4	-12	19,1	1x11	95	56	24	41
1B170-16-16	25	1	-16	25,4	1x11	121	77	33	41

Serie de terminales aprobados para **tipos de manguera**, dependiendo del tamaño:

70 | 371LT | 372 | 372RH | 372TC | 701 | 701 TC | F42-8 | SX35

B2 Hembra giratoria BSP Cilíndrica Codo 90° (Asiento 60°)

BS 5200-B – DKR 90°

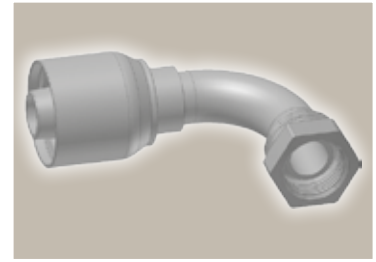
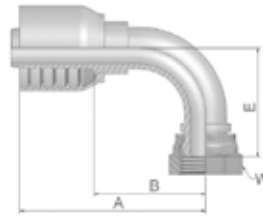

Referencia	D.I. de manguera				Rosca BSP	A mm	B mm	E mm	W mm
	DN	Pulg.	Tamaño	mm					
1B270-6-6	10	3/8	-6	9,5	3/8x19	66	37	33	22
1B270-8-6	10	3/8	-6	9,5	1/2x14	66	37	35	27
1B270-8-8	12	1/2	-8	12,7	1/2x14	70	35	39	27
1B270-10-8	12	1/2	-8	12,7	5/8x14	74	39	38	30
1B270-10-10	16	5/8	-10	15,9	5/8x14	81	41	46	30
1B270-12-10	16	5/8	-10	15,9	3/4x14	92	52	59	32
1B270-16-10	16	5/8	-10	15,9	1x11	86	46	44	41
1B270-12-12	19	3/4	-12	19,1	3/4x14	89	50	53	32
1B270-16-12	19	3/4	-12	19,1	1x11	89	49	51	41
1B270-16-16	25	1	-16	25,4	1x11	116	69	69	41

EA Hembra giratoria BSP con junta tórica (Cono 60°)

BS 5200 – ISO 12151-6 – DKOR

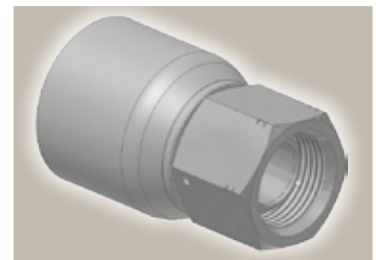
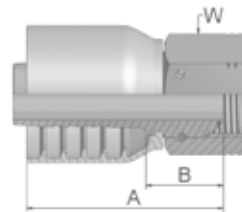

Referencia	D.I. de manguera				Rosca BSP	A mm	B mm	W mm
	DN	Pulg.	Tamaño	mm				
1EA70-8-8	12	1/2	-8	12,7	1/2x14	56	21	27
1EA70-12-12	19	3/4	-12	19,1	3/4x14	63	23	32
1EA70-16-16	25	1	-16	25,4	1x11	77	31	41

Se pueden usar terminales con junta tórica estándar para temperaturas desde -40 °C hasta +105 °C.

Serie de terminales aprobados para **tipos de manguera**, dependiendo del tamaño:

70 | 371LT | 372 | 372RH | 372TC | 701 | 701 TC | F42-8 | SX35

EC Hembra giratoria BSP con junta tórica Codo 90° (Cono 60°)

BS 5200 – ISO 12151-6 – DKOR 90°

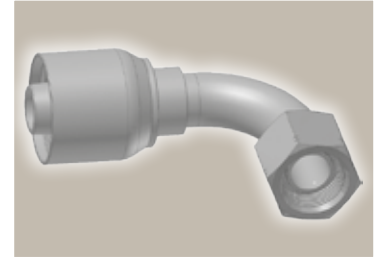
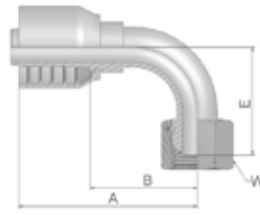

Referencia	D.I. de manguera				Rosca BSP	A mm	B mm	E mm	W mm
	DN	Pulg.	Tamaño	mm					
1EC70-8-8	12	1/2	-8	12,7	1/2x14	71	36	40	27
1EC70-12-12	19	3/4	-12	19,1	3/4x14	89	49	55	32
1EC70-16-16	25	1	-16	25,4	1x11	115	68	71	41

Se pueden usar terminales con junta tórica estándar para temperaturas desde -40 °C hasta +105 °C.

D9 Macho cilíndrico BSP Rígido – Recto (Cono 60°)

BS5200 – AGR

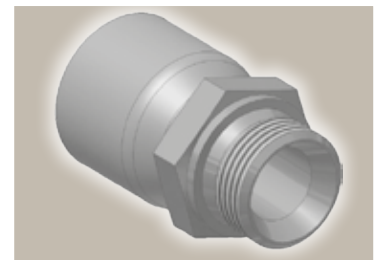
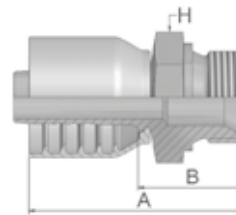

Referencia	D.I. de manguera				Rosca BSP	A mm	B mm	H mm
	DN	Pulg.	Tamaño	mm				
1D970-6-6	10	3/8	-6	9,5	3/8x19	57	28	22
1D970-8-6	10	3/8	-6	9,5	1/2x14	60	31	27
1D970-8-8	12	1/2	-8	12,7	1/2x14	62	28	27
1D970-10-8	12	1/2	-8	12,7	5/8x14	70	36	30
1D970-12-8	12	1/2	-8	12,7	3/4x14	69	35	32
1D970-10-10	16	5/8	-10	15,9	5/8x14	75	36	30
1D970-12-10	16	5/8	-10	15,9	3/4x14	72	35	32
1D970-12-12	19	3/4	-12	19,1	3/4x14	72	33	32
1D970-16-12	19	3/4	-12	19,1	1x11	77	38	41
1D970-16-16	25	1	-16	25,4	1x11	85	40	41

Serie de terminales aprobados para tipos de manguera, dependiendo del tamaño:

70 | 371LT | 372 | 372RH | 372TC | 701 | 701 TC | F42-8 | SX35

01 Macho NPTF fijo Rígido – Recto

SAE J476A / J516 – AGN

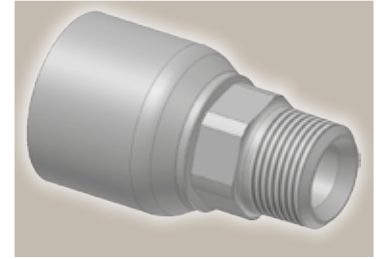
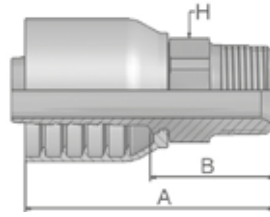

Referencia	D.I. de manguera				Rosca NPTF	A mm	B mm	H mm
	DN	Pulg.	Tamaño	mm				
10170-6-6-SM	10	3/8	-6	9,5	3/8-18	60	31	19
10170-12-8-SM	12	1/2	-8	12,7	3/4-14	68	33	27
10170-8-10-SM	16	5/8	-10	15,9	1/2-14	75	38	24
10170-12-10-SM	16	5/8	-10	15,9	3/4-14	71	34	27
10170-12-12-SM	19	3/4	-12	19,1	3/4-14	79	39	27
10170-16-12-SM	19	3/4	-12	19,1	1-11 1/2	79	39	36
10170-16-16-SM	25	1	-16	25,4	1-11 1/2	93	46	36

03 Macho JIC 37° Rígido – Recto

ISO12151-5-S – AGJ

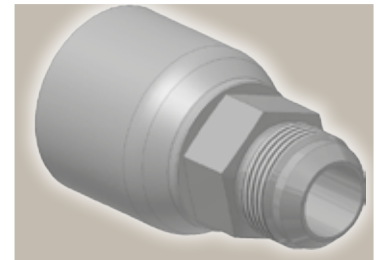
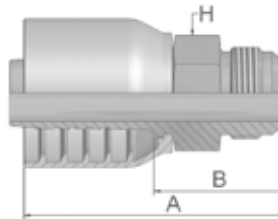

Referencia	D.I. de manguera				Rosca UNF	A mm	B mm	H mm
	DN	Pulg.	Tamaño	mm				
10370-6-6-SM	10	3/8	-6	9,5	9/16x18	60	31	19
10370-8-6-SM	10	3/8	-6	9,5	3/4x16	59	29	19
10370-8-8-SM	12	1/2	-8	12,7	3/4x16	68	33	22
10370-10-8-SM	12	1/2	-8	12,7	7/8x14	67	32	24
10370-12-8-SM	12	1/2	-8	12,7	1 1/16x12	71	36	27
10370-10-10-SM	16	5/8	-10	15,9	7/8x14	75	38	24
10370-12-10-SM	16	5/8	-10	15,9	1 1/16x12	75	36	27
10370-12-12-SM	19	3/4	-12	19,1	1 1/16x12	82	42	27
10370-16-12-SM	19	3/4	-12	19,1	1 5/16x12	77	38	36
10370-16-16-SM	25	1	-16	25,4	1 5/16x12	94	47	36

Serie de terminales aprobados para **tipos de manguera**, dependiendo del tamaño:

70 371LT 372 372RH 372TC 701 701 TC F42-8 SX35

06 Hembra giratoria JIC 37° Recta

ISO12151-5-SWS – DKJ

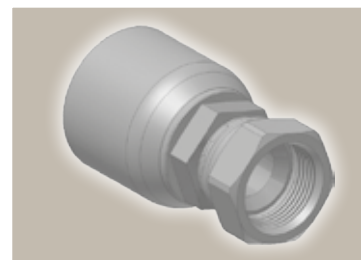
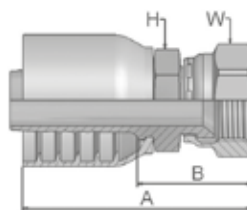

Referencia	D.I. de manguera				Rosca UNF	A mm	B mm	H mm	W mm
	DN	Pulg.	Tamaño	mm					
10670-6-6-SM	10	3/8	-6	9,5	9/16x18	58	29	17	19
10670-8-6-SM	10	3/8	-6	9,5	3/4x16	61	32	19	22
10670-8-8-SM*	12	1/2	-8	12,7	3/4x16	67	32	22	22
10670-12-8-SM	12	1/2	-8	12,7	1 1/16x12	71	36	27	32
10670-10-10-SM	16	5/8	-10	15,9	7/8x14	75	35	24	27
10670-12-10-SM	16	5/8	-10	15,9	1 1/16x12	79	39	27	32
10670-12-12-SM	19	3/4	-12	19,1	1 1/16x12	80	41	27	32
10670-14-12-SM	19	3/4	-12	19,1	1 3/16x12	81	42	32	36
10670-16-12-SM	19	3/4	-12	19,1	1 5/16x12	84	45	32	41
10670-12-16-SM	25	1	-16	25,4	1 1/16x12	89	44	36	32
10670-16-16-SM	25	1	-16	25,4	1 5/16x12	94	47	36	41
10670-20-16-SM	25	1	-16	25,4	1 5/8x12	98	52	41	50

* Estos terminales tienen un asiento dual que acepta configuraciones macho tanto JIC (37°) y SAE (45°)

Serie de terminales aprobados para tipos de manguera, dependiendo del tamaño:

70 371LT 372 372RH 372TC 701 701 TC F42-8 SX35

37 Hembra giratoria JIC 37° Codo 45°

ISO 12151-5-SWE 45° – DKJ 45°

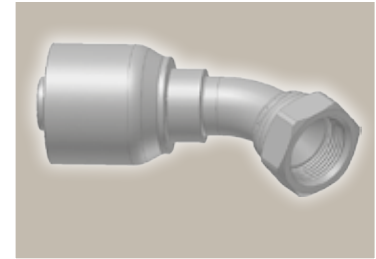
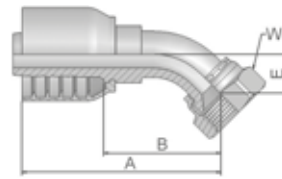

Referencia	D.I. de manguera				Rosca UNF	A mm	B mm	E mm	W mm
	DN	Pulg.	Tamaño	mm					
13770-6-6-SM	10	3/8	-6	9,5	9/16x18	61	32	11	19
13770-8-6-SM*	10	3/8	-6	9,5	3/4x16	70	41	14	22
13770-8-8-SM*	12	1/2	-8	12,7	3/4x16	73	38	14	22
13770-10-8-SM*	12	1/2	-8	12,7	7/8x14	78	43	17	27
13770-8-10-SM*	16	5/8	-10	15,9	3/4x16	78	39	15	22
13770-10-10-SM*	16	5/8	-10	15,9	7/8x14	83	42	16	27
13770-12-10-SM	16	5/8	-10	15,9	1 1/16x12	88	48	21	32
13770-12-12-SM	19	3/4	-12	19,1	1 1/16x12	91	52	20	32
13770-16-16-SM	25	1	-16	25,4	1 5/16x12	111	66	24	41
13770-20-16-SM	25	1	-16	25,4	1 5/8x12	114	67	26	50

* Estos terminales tienen un asiento dual que acepta configuraciones macho tanto JIC (37°) y SAE (45°)

39/3W Hembra giratoria doble Asiento JIC 37° / SAE 45° Codo 90°

ISO 12151-5-SWES – DKJ 90°

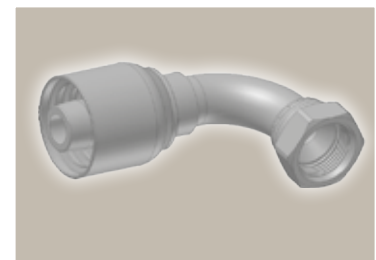
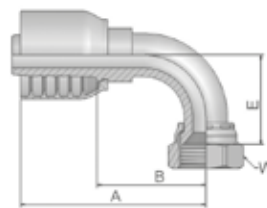

Referencia	D.I. de manguera				Rosca UNF	A mm	B mm	E mm	W mm
	DN	Pulg.	Tamaño	mm					
13970-6-6-SM	10	3/8	-6	9,5	9/16x18	57	28	23	19
13W70-8-6-SM	10	3/8	-6	9,5	3/4x16	64	35	29	22
13970-6-8-SM	12	1/2	-8	12,7	9/16x18	64	29	22	19
13970-12-10-SM	16	5/8	-10	15,9	1 1/16x12	87	48	48	32
13970-12-12-SM	19	3/4	-12	19,1	1 1/16x12	89	50	48	32
13970-16-12-SM	19	3/4	-12	19,1	1 5/16x12	89	50	51	41
13970-12-16-SM	25	1	-16	25,4	1 1/16x12	99	54	46	32
13970-16-16-SM	25	1	-16	25,4	1 5/16x12	109	64	56	41
13970-20-16-SM	25	1	-16	25,4	1 5/8x12	111	64	62	50

* Estos terminales tienen un asiento dual que acepta configuraciones macho tanto JIC (37°) y SAE (45°)

Serie de terminales aprobados para **tipos de manguera**, dependiendo del tamaño:

70 371LT 372 372RH 372TC 701 701 TC F42-8 SX35

15 Brida ISO 6162-1 Recta

ISO 12151-3-S-L – SFL
(21,0 MPa/ 3000 psi)

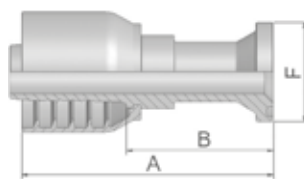

Referencia	D.I. de manguera				Terminal Pulg.	A mm	B mm	F mm
	DN	Pulg.	Tamaño	mm				
11570-8-8	12	1/2	-8	12,7	1/2	89	54	30
11570-10-10	16	5/8	-10	15,9	5/8	116	79	34
11570-12-10	16	5/8	-10	15,9	3/4	69	30	38
11570-12-12	19	3/4	-12	19,1	3/4	98	59	38
11570-16-12	19	3/4	-12	19,1	1	70	31	45
11570-20-12	19	3/4	-12	19,1	1 1/4	75	36	51
11570-12-16	25	1	-16	25,4	3/4	111	66	38
11570-16-16	25	1	-16	25,4	1	108	63	45
11570-20-16	25	1	-16	25,4	1 1/4	82	36	51

Las semibridas SAE se encuentran en la página 43.

Se pueden usar terminales con junta tórica estándar para temperaturas desde -40 °C hasta +105 °C.

17 Brida ISO 6162-1 Codo 45°

ISO 12151-3 – E45 – L – SFL 45°
(35,0 MPa/ 5000 psi)

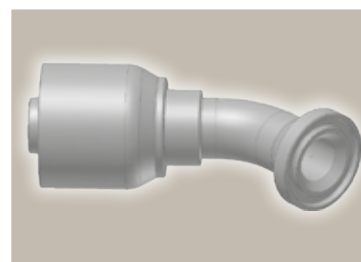
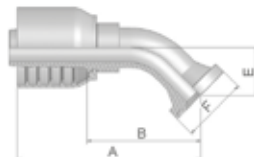

Referencia	D.I. de manguera				Terminal Pulg.	A mm	B mm	E mm	F mm
	DN	Pulg.	Tamaño	mm					
11770-8-8	12	1/2	-8	12,7	1/2	79	44	20	30
11770-10-10	16	5/8	-10	15,9	5/8	104	67	24	34
11770-12-10	16	5/8	-10	15,9	3/4	96	57	26	38
11770-12-12	19	3/4	-12	19,1	3/4	98	58	26	38
11770-16-12	19	3/4	-12	19,1	1	97	57	25	45
11770-16-16	25	1	-16	25,4	1	119	73	27	45
11770-20-16	25	1	-16	25,4	1 1/4	121	76	32	51

Las semibridas SAE se encuentran en la página 43.

Se pueden usar terminales con junta tórica estándar para temperaturas desde -40 °C hasta +105 °C.

Serie de terminales aprobados para **tipos de manguera**, dependiendo del tamaño:

70 | 371LT | 372 | 372RH | 372TC | 701 | 701 TC | F42-8 | SX35

19 Brida ISO 6162-1 Codo 90°

ISO 12151-3 – E– L – SFL 90°
(21,0 MPa/ 3000 psi)

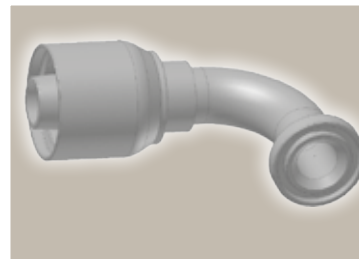
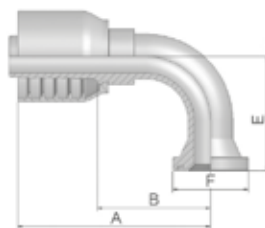

Referencia	D.I. de manguera				Terminal	A	B	E	F
	DN	Pulg.	Tamaño	mm					
11970-8-8	12	1/2	-8	12,7	1/2	75	40	41	30
11970-12-8	12	1/2	-8	12,7	3/4	77	42	42	38
11970-10-10	16	5/8	-10	15,9	5/8	92	55	55	34
11970-12-10	16	5/8	-10	15,9	3/4	95	65	54	38
11970-12-12	19	3/4	-12	19,1	3/4	89	50	58	38
11970-16-12	19	3/4	-12	19,1	1	90	50	58	45
11970-16-16	25	1	-16	25,4	1	105	55	61	45
11970-20-16	25	1	-16	25,4	1 1/4	113	68	70	51

Las semibridas SAE se encuentran en la página 43.

Se pueden usar terminales con junta tórica estándar para temperaturas desde -40 °C hasta +105 °C.

6A Brida ISO 6162-2 Recta

ISO 12151-3-S-S – SFS
(42,0 MPa/ 6000 psi)

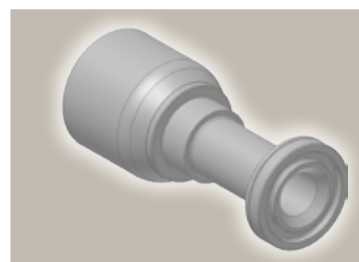
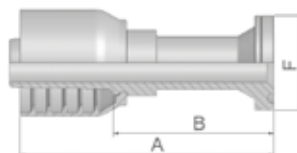

Referencia	D.I. de manguera				Terminal	A	B	F
	DN	Pulg.	Tamaño	mm				
16A70-8-8	12	1/2	-8	12,7	1/2	103	68	32
16A70-12-8	12	1/2	-8	12,7	3/4	105	70	41
16A70-8-10	16	5/8	-10	15,9	1/2	107	68	32
16A70-12-10	16	5/8	-10	15,9	3/4	117	78	41
16A70-8-12	19	3/4	-12	19,1	1/2	107	67	32
16A70-12-12	19	3/4	-12	19,1	3/4	105	66	41
16A70-16-12	19	3/4	-12	19,1	1	110	70	48
16A70-12-16	25	1	-16	25,4	3/4	127	82	41
16A70-16-16	25	1	-16	25,4	1	127	82	48
16A70-20-16	25	1	-16	25,4	1 1/4	127	82	54

Las semibridas SAE se encuentran en la página 43.

Se pueden usar terminales con junta tórica estándar para temperaturas desde -40 °C hasta +105 °C.

Serie de terminales aprobados para **tipos de manguera**, dependiendo del tamaño:

70 | 371LT | 372 | 372RH | 372TC | 701 | 701 TC | F42-8 | SX35

6F Brida ISO 6162-2 Codo 45°

ISO 12151-3 – E45-S – SFS 45°
(42,0 MPa/ 6000 psi)

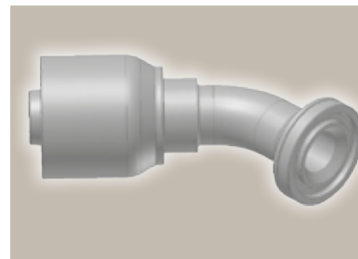
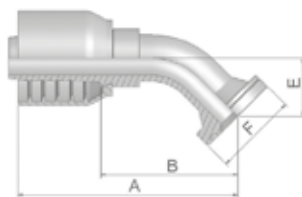

Referencia	D.I. de manguera				Terminal Pulg.	A mm	B mm	E mm	F mm
	DN	Pulg.	Tamaño	mm					
16F70-8-8	12	1/2	-8	12,7	1/2	81	46	19	32
16F70-12-8	12	1/2	-8	12,7	3/4	90	55	26	41
16F70-8-10	16	5/8	-10	15,9	1/2	92	53	26	32
16F70-12-10	16	5/8	-10	15,9	3/4	92	55	26	41
16F70-8-12	19	3/4	-12	19,1	1/2	94	54	26	32
16F70-12-12	19	3/4	-12	19,1	3/4	105	66	26	41
16F70-16-12	19	3/4	-12	19,1	1	101	62	26	48
16F70-12-16	25	1	-16	25,4	3/4	118	73	27	41
16F70-16-16	25	1	-16	25,4	1	117	77	27	48
16F70-20-16	25	1	-16	25,4	1 1/4	117	70	31	54

Las semibridas SAE se encuentran en la página 43.

Se pueden usar terminales con junta tórica estándar para temperaturas desde -40 °C hasta +105 °C.

6N Brida ISO 6162-2 Codo 90°

ISO 12151-3 – E-S – SFS 90°
(42,0 MPa/ 6000 psi)

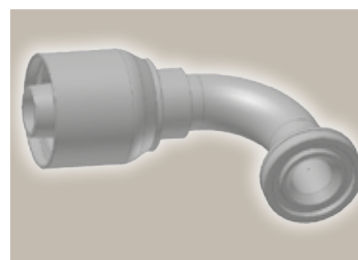
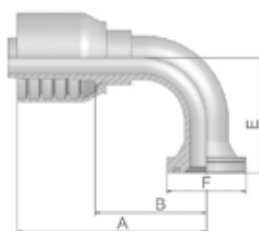

Referencia	D.I. de manguera				Terminal Pulg.	A mm	B mm	E mm	F mm
	DN	Pulg.	Tamaño	mm					
16N70-8-8	12	1/2	-8	12,7	1/2	74	39	41	32
16N70-12-8	12	1/2	-8	12,7	3/4	79	44	45	41
16N70-8-10	16	5/8	-10	15,9	1/2	95	56	54	32
16N70-12-10	16	5/8	-10	15,9	3/4	92	55	54	41
16N70-16-10	16	5/8	-10	15,9	1	86	46	54	48
16N70-8-12	19	3/4	-12	19,1	1/2	81	42	54	32
16N70-12-12	19	3/4	-12	19,1	3/4	98	58	54	41
16N70-16-12	19	3/4	-12	19,1	1	92	53	53	48
16N70-12-16	25	1	-16	25,4	3/4	113	66	57	41
16N70-16-16	25	1	-16	25,4	1	111	64	70	48
16N70-20-16	25	1	-16	25,4	1 1/4	115	68	68	54

Las semibridas SAE se encuentran en la página 43.

Se pueden usar terminales con junta tórica estándar para temperaturas desde -40 °C hasta +105 °C.

Serie de terminales aprobados para tipos de manguera, dependiendo del tamaño:

70 | 371LT | 372 | 372RH | 372TC | 701 | 701 TC | F42-8 | SX35

PY **Brida – Macho 24°**
Gas Francés
Recta

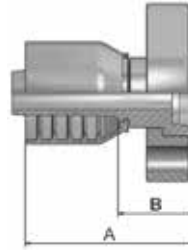

Referencia	 D.I. de manguera				A mm	B mm
	DN	Pulg.	Tamaño	mm		
1PY70-10-10	16	5/8	-10	15,9	63	24
1PY70-12-12	19	3/4	-12	19,1	69	30
1PY70-16-16	25	1	-16	25,4	87	41

Serie de terminales aprobados para **tipos de manguera**, dependiendo del tamaño:

70 | 371LT | 372 | 372RH | 372TC | 701 | 701 TC | F42-8 | SX35

JC Hembra giratoria ORFS Recta - Corta

ISO 12151-1 - SWSA
SAE J516 - ORFS

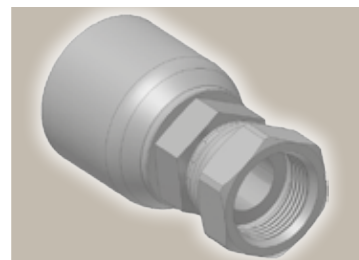
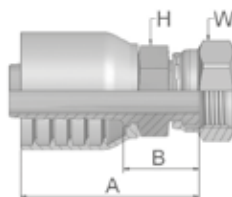

Referencia	D.I. de manguera				Rosca UNF	A mm	B mm	H mm	W mm
	DN	Pulg.	Tamaño	mm					
1JC70-6-6-SM	10	3/8	-6	9,5	11/16x16	49	20	19	22
1JC70-8-6-SM	10	3/8	-6	9,5	13/16x16	51	22	19	24
1JC70-8-8-SM	12	1/2	-8	12,7	13/16x16	56	24	13/16	15/16
1JC70-10-8-SM	12	1/2	-8	12,7	1x14	58	24	24	30
1JC70-12-8-SM	12	1/2	-8	12,7	1 3/16x12	63	28	32	36
1JC70-8-10-SM	16	5/8	-10	15,9	13/16x16	58	22	24	24
1JC70-10-10-SM	16	5/8	-10	15,9	1x14	64	24	24	30
1JC70-12-10-SM	16	5/8	-10	15,9	1 3/16x12	68	29	32	36
1JC70-8-12-SM	19	3/4	-12	19,1	13/16x16	61	22	27	24
1JC70-12-12-SM	19	3/4	-12	19,1	1 3/16x12	68	29	32	36
1JC70-16-12-SM	19	3/4	-12	19,1	1 7/16x12	72	33	36	41
1JC70-12-16-SM	25	1	-16	25,4	13/16x12	76	31	36	36
1JC70-16-16-SM	25	1	-16	25,4	1 7/16x12	80	35	36	41
1JC70-20-16-SM	25	1	-16	25,4	1 11/16x12	79	34	41	50

JS Hembra giratoria ORFS (Larga)

ISO 12151-1-SWSB
SAE J516 - ORFS

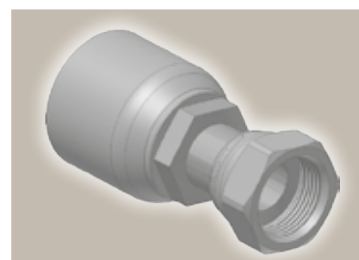
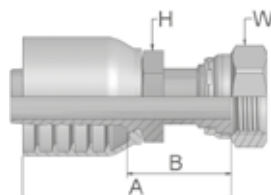

Referencia	D.I. de manguera				Rosca UNF	A mm	B mm	H mm	W mm
	DN	Pulg.	Tamaño	mm					
1JS70-6-6-SM	10	3/8	-6	9,5	11/16x16	58	29	17	22
1JS70-8-6-SM	10	3/8	-6	9,5	13/16x16	64	35	19	24
1JS70-8-8-SM	12	1/2	-8	12,7	13/16x16	67	33	22	24
1JS70-10-8-SM	12	1/2	-8	12,7	1x14	73,5	38,5	24	30
1JS70-10-10-SM	16	5/8	-10	15,9	1x14	79	39	24	30
1JS70-12-12-SM	19	3/4	-12	19,1	1 3/16x12	84	45	30	36
1JS70-16-12-SM	19	3/4	-12	19,1	1 7/16x12	86	47	36	41
1JS70-16-16-SM	25	1	-16	25,4	1 7/16x12	98	53	36	41
1JS70-20-16-SM	25	1	-16	25,4	1 11/16x12	94	47	41	50

Serie de terminales aprobados para **tipos de manguera**, dependiendo del tamaño:

70 | 371LT | 372 | 372RH | 372TC | 701 | 701 TC | F42-8 | SX35

J7 Hembra giratoria ORFS Codo 45°

ISO 12151-1 – SWE 45°
SAE J516 – ORFS 45°

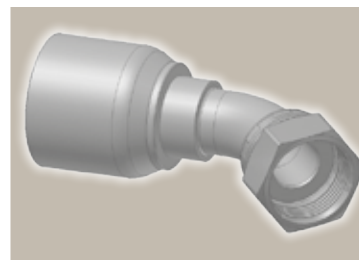
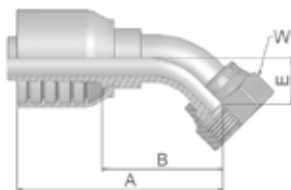

Referencia	D.I. de manguera				Rosca UNF	A mm	B mm	E mm	W mm
	DN	Pulg.	Tamaño	mm					
1J770-6-6-SM	10	3/8	-6	9,5	11/16x16	62	33	11	22
1J770-8-6-SM	10	3/8	-6	9,5	13/16x16	64	35	15	24
1J770-6-8-SM	12	1/2	-8	12,7	11/16x16	68	33	11	22
1J770-8-8-SM	12	1/2	-8	12,7	13/16x16	72	37	15	24
1J770-10-8-SM	12	1/2	-8	12,7	1x14	80	46	17	30
1J770-10-10-SM	16	5/8	-10	15,9	1x14	83	44	16	30
1J770-12-10-SM	16	5/8	-10	15,9	1 3/16x12	90	53	21	36
1J770-12-12-SM	19	3/4	-12	19,1	1 3/16x12	92	53	21	36
1J770-16-12-SM	19	3/4	-12	19,1	1 7/16x12	95	56	24	41
1J770-16-16-SM	25	1	-16	25,4	1 7/16x12	113	66	24	41

J9 Hembra giratoria ORFS Codo 90° – Corto

ISO 12151-1 – SWES
SAE J516 – ORFS 90°

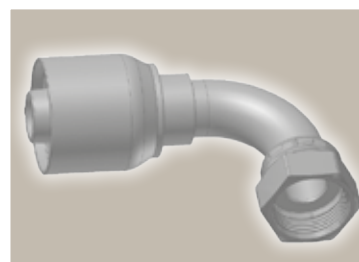
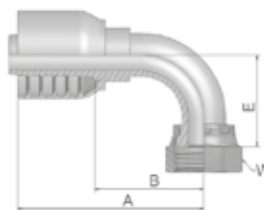

Referencia	D.I. de manguera				Rosca UNF	A mm	B mm	E mm	W mm
	DN	Pulg.	Tamaño	mm					
1J970-6-6-SM	10	3/8	-6	9,5	11/16x16	58	29	23	22
1J970-8-6-SM	10	3/8	-6	9,5	13/16x16	58	29	29	24
1J970-8-8-SM	12	1/2	-8	12,7	13/16x16	70	35	29	24
1J970-10-8-SM	12	1/2	-8	12,7	1x14	73	38	32	30
1J970-12-8-SM	12	1/2	-8	12,7	1 3/16x12	76	41	48	36
1J970-10-10-SM	16	5/8	-10	15,9	1x14	78	39	33	30
1J970-12-10-SM	16	5/8	-10	15,9	1 3/16x12	86	50	48	36
1J970-12-12-SM	19	3/4	-12	19,1	1 3/16x12	89	49	48	36
1J970-16-12-SM	19	3/4	-12	19,1	1 7/16x12	89	49	56	41
1J970-16-16-SM	25	1	-16	25,4	1 7/16x12	111	64	56	41
1J970-20-16-SM	25	1	-16	25,4	1 11/16x12	111	64	64	50

Serie de terminales aprobados para tipos de manguera, dependiendo del tamaño:

70 371LT 372 372RH 372TC 701 701 TC F42-8 SX35

J1 Hembra giratoria ORFS Codo 90° - Largo

ISO 12151-1 – SWEL
SAE J 516 – ORFS 90° L

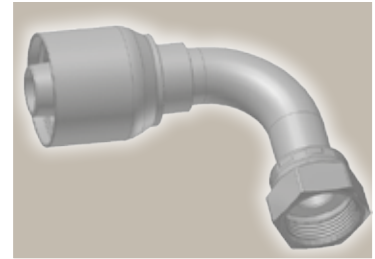
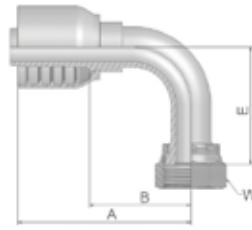

Referencia	D.I. de manguera				Rosca UNF	A mm	B mm	E mm	W mm
	DN	Pulg.	Tamaño	mm					
1J170-8-8-SM	12	1/2	-8	12,7	13/16x16	71	36	64	24
1J170-10-8-SM	12	1/2	-8	12,7	1x14	73	38	70	30
1J170-10-10-SM	16	5/8	-10	15,9	1x14	78	39	70	30
1J170-12-10-SM	16	5/8	-10	15,9	1 3/16x12	76	40	96	36
1J170-12-12-SM	19	3/4	-12	19,1	1 3/16x12	89	49	96	36
1J170-16-16-SM	25	1	-16	25,4	1 7/16x12	109	64	114	41

JM Macho ORFS

ISO 12151-1-S – SAE J516

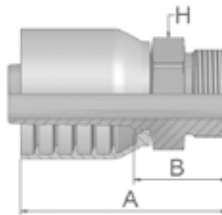

Referencia	D.I. de manguera				Rosca UNF	A mm	B mm	H mm
	DN	Pulg.	Tamaño	mm				
1JM70-6-6-SM	10	3/8	-6	9,5	11/16x16	53	24	19
1JM70-8-6-SM	10	3/8	-6	9,5	13/16x16	56	27	22
1JM70-8-8-SM	12	1/2	-8	12,7	13/16x16	62	27	22
1JM70-10-8-SM	12	1/2	-8	12,7	1x14	66	32	27
1JM70-10-10-SM	16	5/8	-10	15,9	1x14	68	32	27
1JM70-12-10-SM	16	5/8	-10	15,9	1 3/16x12	71	34	32
1JM70-12-12-SM	19	3/4	-12	19,1	1 3/16x12	74	34	32
1JM70-16-12-SM	19	3/4	-12	19,1	1 7/16x12	74	35	41
1JM70-16-16-SM	25	1	-16	25,4	1 7/16x12	84	39	41
1JM70-20-16-SM	25	1	-16	25,4	1 11/16x12	82	37	46

Los terminales JM se suministran sin junta tórica.





Serie de terminales aprobados para tipos de manguera, dependiendo del tamaño:

70 371LT 372 372RH 372TC 701 701 TC F42-8 SX35

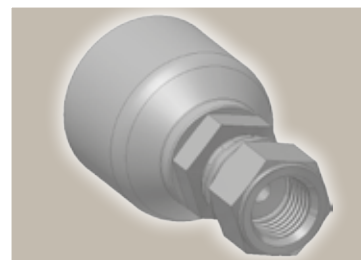
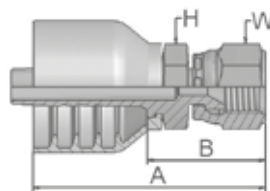
MU Hembra giratoria métrica Recta (Abocardado 30°)

JIS B8363 – MU



Referencia	 D.I. de manguera				 Rosca métrica	A mm	B mm	 H mm	 W mm
	DN	Pulg.	Tamaño	mm					
1MU70-6-6	10	3/8	-6	9,5	M18x1,5	62	33	24	24
1MU70-8-8	12	1/2	-8	12,7	M22x1,5	72	37	27	27
1MU70-12-12	19	3/4	-12	19,1	M27x2	81	41	36	36

Serie de terminales aprobados para **tipos de manguera**, dependiendo del tamaño:

70 371LT 372 372RH 372TC 701 701 TC F42-8 SX35

FG Macho Gaz francés Rígido Recto (Cono 24°)

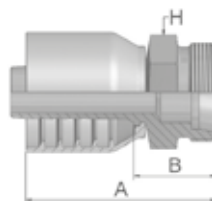

Referencia	D.I. de manguera				Rosca métrica	Tubo D.E. mm	A mm	B mm	H mm
	DN	Pulg.	Tamaño	mm					
1FG70-13-6	10	3/8	-6	9,5	M20x1,5	13,25	46	24	22
1FG70-17-8	12	1/2	-8	12,7	M24x1,5	16,75	62	27	24
1FG70-21-10	16	5/8	-10	15,9	M30x1,5	21,25	70	30	30
1FG70-27-12	19	3/4	-12	19,1	M36x1,5	26,75	70	30	36
1FG70-33-16	25	1	-16	25,4	M45x1,5	33,50	82	36	46

F4 Hembra giratoria francesa Serie Gaz Recta (Asiento ovalado)

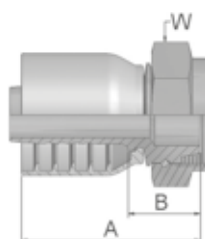

Referencia	D.I. de manguera				Rosca métrica	Tubo D.E. mm	A mm	B mm	W mm
	DN	Pulg.	Tamaño	mm					
1F470-13-6	10	3/8	-6	9,5	M20x1,5	13	52	22	24
1F470-17-8	12	1/2	-8	12,7	M24x1,5	17	60	25	30
1F470-21-10	16	5/8	-10	15,9	M30x1,5	21	62	25	36
1F470-27-12	19	3/4	-12	19,1	M36x1,5	27	70	31	46

Serie de terminales aprobados para tipos de manguera, dependiendo del tamaño:

70 371LT 372 372RH 372TC 701 701 TC F42-8 SX35

XU Hembra giratoria métrica Recta (Abocardado 30°)

JIS B8363

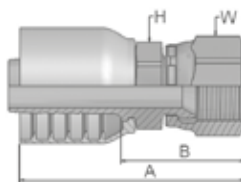

Referencia	D.I. de manguera				Rosca métrica	A mm	B mm	H mm	W mm
	DN	Pulg.	Tamaño	mm					
1XU70-10-10	16	5/8	-10	15,9	M24x1,5	67	28	30	32
1XU70-12-12	19	3/4	-12	19,1	M30x1,5	68	28	32	36
1XU70-16-16	25	1	-16	25,4	M33x1,5	82	35	36	41

XY Hembra giratoria métrica Codo 90° (Abocardado 30°)

JIS B8363

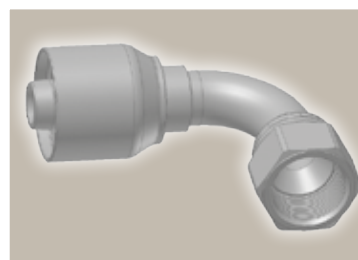
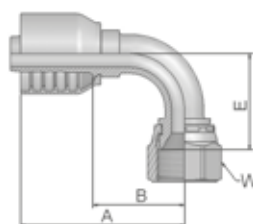

Referencia	D.I. de manguera				Rosca métrica	A mm	B mm	E mm	W mm
	DN	Pulg.	Tamaño	mm					
1XY70-10-10	16	5/8	-10	15,9	M24x1,5	77	41	41	32
1XY70-12-12	19	3/4	-12	19,1	M24x1,5	89	49	52	36

Serie de terminales aprobados para tipos de manguera, dependiendo del tamaño:

70 371LT 372 372RH 372TC 701 701 TC F42-8 SX35

RACORES SERIE 73



DIN – Métrica

Página Dc-1 – Dc-3

CA

Dc-1



Hembra giratoria métrica 24°
Serie ligera con junta tórica
Recta
ISO 12151-2-SWS-L – DKOL

CE

Dc-1



Hembra giratoria métrica 24°
Serie ligera con junta tórica
Codo 45°
ISO 12151-2-SWE 45°-L – DKOL 45°

C9

Dc-2



Hembra giratoria métrica 24°
Serie pesada con junta tórica
Recta
ISO 12151-2-SWS-S – DKOS

OC

Dc-2



Hembra giratoria métrica 24°
Serie pesada con junta tórica
Codo 45°
ISO 12151-2 – SWE 45°-S – DKOS 45°

1C

Dc-3



Hembra giratoria métrica 24°
Serie pesada con junta tórica
Codo 90°
ISO 12151-2-SWE-S – DKOS 90°

D2

Dc-3



Macho métrico recto 24°
Serie pesada
Rígido
ISO 12151-2-S-S – CES

BSP

Página Dc-4 – Dc-5

92

Dc-4



Hembra giratoria BSP
(Asiento 60°)
BS5200-A – DKR

B1

Dc-4

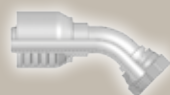

Hembra giratoria BSP cónica
Codo 45° (Cono 60°)
BS 5200-D – DKR 45°

B2

Dc-5



Hembra giratoria BSP
Cilíndrica
Codo 90° (Asiento 60°)
BS 5200-B – DKR 90°

D9

Dc-5

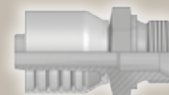

Macho cilíndrico BSP
Rígido – Recto (Cono 60°)
BS5200 – AGR

SAE

Página Dc-6 – Dc-8

01

Dc-6

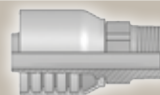

Macho NPTF fijo
Rígido – Recto
SAE J476A / J516 – AGN

03

Dc-6

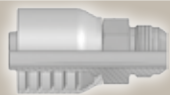

Macho JIC 37°
Rígido – Recto
ISO12151-5-S – AGJ

06

Dc-7

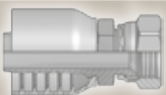

Hembra giratoria JIC 37°
Recta
ISO12151-5-SWS – DKJ

37

Dc-7



Hembra giratoria JIC 37°
Codo 45°
ISO 12151-5-SWE 45° – DKJ 45°

39

Dc-8

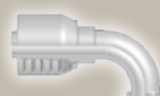

Hembra giratoria JIC 37°
Codo 90°
ISO 12151-5-SWES – DKJ 90°





Bridas

Página Dc-9 – Dc-14

<p>15/4A Dc-9</p>  <p>Brida ISO 6162-1 Recta ISO 12151-3-S-L – SFL (35,0 MPa/ 5000 psi)</p>	<p>17/4F Dc-9</p>  <p>Brida ISO 6162-1 Codo 45° ISO 12151-3 – E45S – L – SFL 45° (35,0 MPa/ 5000 psi)</p>	<p>19/4N Dc-10</p>  <p>Brida ISO 6162-1 Codo 90° ISO 12151-3-E-L – SFL 90° (35,0 MPa/ 5000 psi)</p>	
<p>6A Dc-10</p>  <p>Brida ISO 6162-2 Recta ISO 12151-3-S-S – SFS (42,0 MPa/ 6000 psi)</p>	<p>6E Dc-11</p>  <p>Brida ISO 6162-2 Codo 30° SFS 30° (42,0 MPa/ 6000 psi)</p>	<p>6F Dc-11</p>  <p>Brida ISO 6162-2 Codo 45° ISO 12151-3 – E45-S – SFS 45° (42,0 MPa/ 6000 psi)</p>	<p>6N Dc-12</p>  <p>Brida ISO 6162-2 Codo 90° ISO 12151-3 – E-S – SFS 90° (42,0 MPa/ 6000 psi)</p>
<p>XA Dc-12</p>  <p>Brida Caterpillar® Recta</p>	<p>XF Dc-13</p>  <p>Brida Caterpillar® Codo 45°</p>	<p>XG Dc-13</p>  <p>Brida Caterpillar® Codo 60°</p>	<p>XN Dc-14</p>  <p>Brida Caterpillar® Codo 90°</p>

ORFS

Página Dc-15 – Dc-17

<p>JC Dc-15</p>  <p>Hembra giratoria ORFS Recta – Corta ISO 12151-1 – SWSA SAE J516 – ORFS</p>	<p>JS Dc-15</p>  <p>Hembra giratoria ORFS (Larga) ISO 12151-1-SWSB SAE J516 – ORFS</p>	<p>J7 Dc-16</p>  <p>Hembra giratoria ORFS Codo 45° ISO 12151-1 – SWE 45° SAE J516 – ORFS 45°</p>	<p>J9 Dc-16</p>  <p>Hembra giratoria ORFS Codo 90° – Corto ISO 12151-1 – SWES SAE J516 – ORFS 90°</p>
<p>JM Dc-17</p>  <p>Macho ORFS ISO 12151-1-S – SAE J516</p>			

Estándar Francés

Página Dc-18 – Dc-19

<p>FG Dc-18</p>  <p>Macho Gaz francés Rígido Recto (Codo 24°)</p>	<p>F2 Dc-18</p>  <p>Hembra giratoria francesa Serie Gaz Codo 90°</p>	<p>F4 Dc-19</p>  <p>Hembra giratoria francesa Serie Gaz Recta (Asiento ovalado)</p>	<p>XU Dc-20</p>  <p>Hembra giratoria métrica Recta (Abocardado 30°) JIS B8363</p>
--	---	---	--

Otros

Página Dc-20

CA Hembra giratoria métrica 24° Serie ligera con junta tórica Recta

ISO 12151-2-SWS-L – DKOL

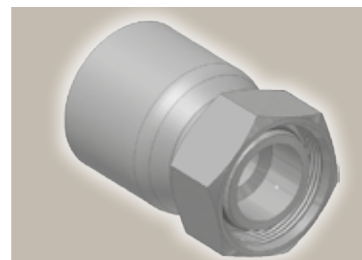
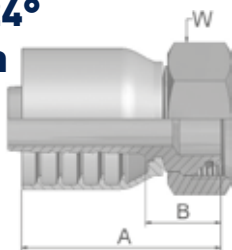

Referencia	D.I. de manguera				Rosca métrica	Tubo D.E. mm	A mm	B mm	W mm
	DN	Pulg.	Tamaño	mm					
1CA73-28-16	25	1	-16	25,4	M36x2	28	87	36	41
1CA73-35-20	31	1 1/4	-20	31,8	M45x2	35	103	39	50
1CA73-42-24	38	1 1/2	-24	38,1	M52x2	42	104	41	60

Se pueden usar terminales con junta tórica estándar para temperaturas desde -40 °C hasta +105 °C.

CE Hembra giratoria métrica 24° Serie ligera con junta tórica Codo 45°

ISO 12151-2-SWE 45°-L – DKOL 45°

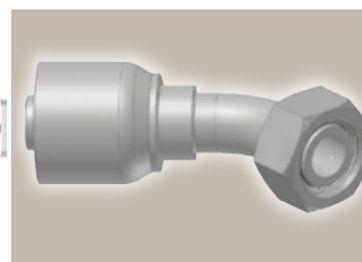
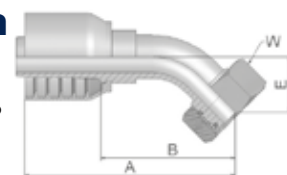

Referencia	D.I. de manguera				Rosca métrica	Tubo D.E. mm	A mm	B mm	E mm	W mm
	DN	Pulg.	Tamaño	mm						
1CE73-35-20	31	1 1/4	-20	31,8	M45x2	35	162	97	37	50

Se pueden usar terminales con junta tórica estándar para temperaturas desde -40 °C hasta +105 °C.

Serie de terminales aprobados para tipos de manguera:

73 | 731 | 731TC | SX35 | SX42

C9 Hembra giratoria métrica 24° Serie pesada con junta tórica Recta

ISO 12151-2-SWS-S – DKOS

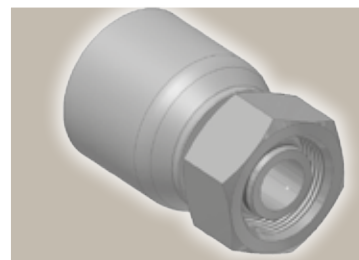
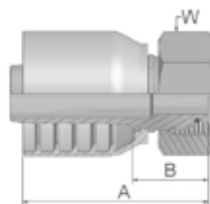

Referencia	D.I. de manguera				Rosca métrica	Tubo D.E. mm	A mm	B mm	W mm
	DN	Pulg.	Tamaño	mm					
1C973-20-12	19	3/4	-12	19,1	M30x2	20	81	33	36
1C973-25-12	19	3/4	-12	19,1	M36x2	25	79	31	46
1C973-25-12SW41	19	3/4	-12	19,1	M36x2	25	79	31	41
1C973-30-12	19	3/4	-12	19,1	M42x2	30	82	34	50
1C973-25-16	25	1	-16	25,4	M36x2	25	87	36	46
1C973-30-16	25	1	-16	25,4	M42x2	30	87	36	50
1C973-25-20	31	1 1/4	-20	31,8	M36x2	25	102	38	46
1C973-30-20	31	1 1/4	-20	31,8	M42x2	30	106	42	50
1C973-38-20	31	1 1/4	-20	31,8	M52x2	38	101	37	60
1C973-38-24	38	1 1/2	-24	38,1	M52x2	38	105	42	60

Se pueden usar terminales con junta tórica estándar para temperaturas desde -40 °C hasta +105 °C.

OC Hembra giratoria métrica 24° Series pesada con junta tórica Codo 45°

ISO 12151-2 – SWE 45°-S – DKOS 45°

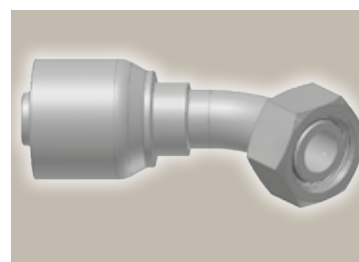
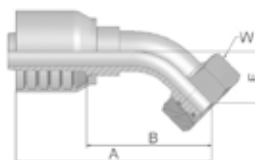

Referencia	D.I. de manguera				Rosca métrica	Tubo D.E. mm	A mm	B mm	E mm	W mm
	DN	Pulg.	Tamaño	mm						
10C73-20-12	19	3/4	-12	19,1	M30x2	20	113	65	30	36
10C73-25-12	19	3/4	-12	19,1	M36x2	25	112	64	29	46
10C73-25-12SW41	19	3/4	-12	19,1	M36x2	25	112	64	29	41
10C73-25-16	25	1	-16	25,4	M36x2	25	128	78	33	46
10C73-30-16	25	1	-16	25,4	M42x2	30	137	128	33	50
10C73-25-20	31	1 1/4	-20	31,8	M36x2	25	150	86	33	46
10C73-30-20	31	1 1/4	-20	31,8	M42x2	30	155	91	34	50
10C73-38-20	31	1 1/4	-20	31,8	M52x2	38	161	97	37	60
10C73-38-24	38	1 1/2	-24	38,1	M52x2	38	182	120	49	60

Se pueden usar terminales con junta tórica estándar para temperaturas desde -40 °C hasta +105 °C.

Serie de terminales aprobados para tipos de manguera:

73 731 731TC SX35 SX42

1C Hembra giratoria métrica 24° Serie pesada con junta tórica Codo 90°

ISO 12151-2-SWE-S – DKOS 90°

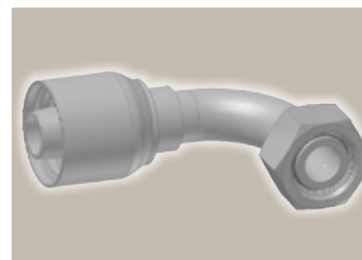
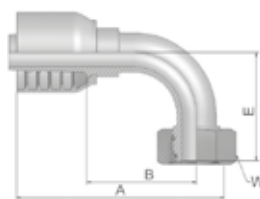

Referencia	D.I. de manguera				Rosca métrica	Tubo D.E. mm	A mm	B mm	E mm	W mm
	DN	Pulg.	Tamaño	mm						
11C73-20-12	19	3/4	-12	19,1	M30x2	20	101	53	60	36
11C73-25-12	19	3/4	-12	19,1	M36x2	25	101	53	59	46
11C73-25-12SW41	19	3/4	-12	19,1	M36x2	25	101	53	59	41
11C73-25-16	25	1	-16	25,4	M36x2	25	117	67	69	46
11C73-30-16	25	1	-16	25,4	M42x2	30	130	118	67	50
11C73-30-20	31	1 1/4	-20	31,8	M42x2	30	137	73	73	50
11C73-38-20	31	1 1/4	-20	31,8	M52x2	38	151	87	78	60
11C73-38-24	38	1 1/2	-24	38,1	M52x2	38	166	103	101	60
11C73-38-32	51	2	-32	50,8	M52x2	38	224	152	166	60

Se pueden usar terminales con junta tórica estándar para temperaturas desde -40 °C hasta +105 °C.

D2 Macho métrico recto 24° Serie pesada Rígido

ISO 12151-2-S-S – CES

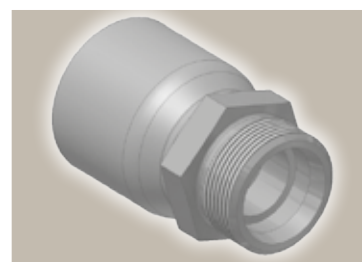
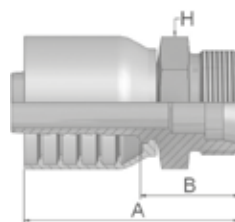

Referencia	D.I. de manguera				Rosca métrica	Tubo D.E. mm	A mm	B mm	H mm
	DN	Pulg.	Tamaño	mm					
1D273-20-12	19	3/4	-12	19,1	M30x2	20	84	35	30
1D273-25-12	19	3/4	-12	19,1	M36x2	25	86	38	36
1D273-30-12	19	3/4	-12	19,1	M42x2	30	90	42	46
1D273-25-16	25	1	-16	25,4	M36x2	25	91	40	36
1D273-30-16	25	1	-16	25,4	M42x2	30	94	42	46
1D273-30-20	31	1 1/4	-20	31,8	M42x2	30	110	46	46
1D273-38-20	31	1 1/4	-20	31,8	M52x2	38	112	46	55

Serie de terminales aprobados para tipos de manguera:

73 731 731TC SX35 SX42

92 Hembra giratoria BSP (Asiento 60°)

BS5200-A – DKR

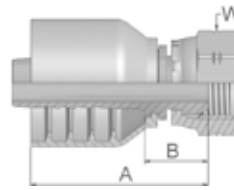

Referencia	D.I. de manguera				Rosca BSP	A mm	B mm	W mm
	DN	Pulg.	Tamaño	mm				
19273-12-12	19	3/4	-12	19,1	3/4x14	75	27	32
19273-16-16	25	1	-16	25,4	1x11	89	38	41
19273-20-20	31	1 1/4	-20	31,8	1 1/4x11	101	37	50
19273-24-20	31	1 1/4	-20	31,8	1 1/2x11	101	37	55
19273-24-24	38	1 1/2	-24	38,1	1 1/2x11	100	37	55
19273-32-32	51	2	-32	50,8	2x11	113	38	70

B1 Hembra giratoria BSP cónica Codo 45° (Cono 60°)

BS 5200-D – DKR 45°

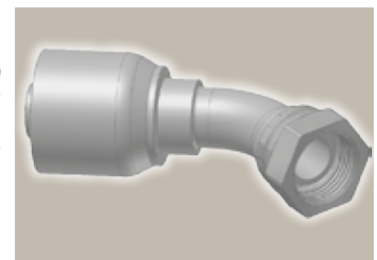
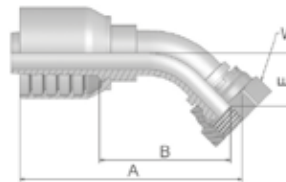

Referencia	D.I. de manguera				Rosca BSP	A mm	B mm	E mm	W mm
	DN	Pulg.	Tamaño	mm					
1B173-12-12	19	3/4	-12	19,1	3/4x14	110	62	26	32
1B173-16-16	25	1	-16	25,4	1x11	136	84	36	41
1B173-20-20	31	1 1/4	-20	31,8	1 1/4x11	168	104	43	50
1B173-24-24	38	1 1/2	-24	38,1	1 1/2x11	186	123	52	55
1B173-32-32	51	2	-32	50,8	2x11	249	177	70	70

Serie de terminales aprobados para tipos de manguera:

73 | 731 | 731TC | SX35 | SX42

B2 Hembra giratoria BSP Cilíndrica Codo 90° (Asiento 60°)

BS 5200-B – DKR 90°

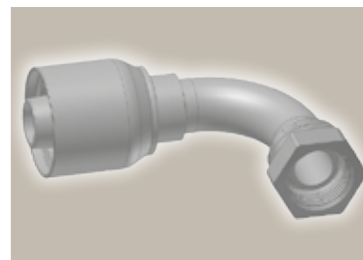
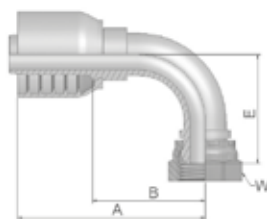

Referencia	D.I. de manguera				Rosca BSP	A mm	B mm	E mm	W mm
	DN	Pulg.	Tamaño	mm					
1B273-12-12	19	3/4	-12	19,1	3/4x14	106	58	55	32
1B273-16-16	25	1	-16	25,4	1x11	120	70	74	41
1B273-20-20	31	1 1/4	-20	31,8	1 1/4x11	151	87	80	50
1B273-24-20	31	1 1/4	-20	31,8	1 1/2x11	151	87	80	55
1B273-24-24	38	1 1/2	-24	38,1	1 1/2x11	166	103	103	55
1B273-32-32	51	2	-32	50,8	2x11	229	157	121	70

D9 Macho cilíndrico BSP Rígido – Recto (Cono 60°)

BS5200 – AGR

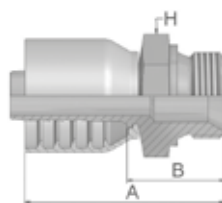

Referencia	D.I. de manguera				Rosca BSP	A mm	B mm	H mm
	DN	Pulg.	Tamaño	mm				
1D973-12-12	19	3/4	-12	19,1	3/4x14	87	39	32
1D973-16-16	25	1	-16	25,4	1x11	96	43	41
1D973-20-20	31	1 1/4	-20	31,8	1 1/4x11	113	49	50
1D973-24-24	38	1 1/2	-24	38,1	1 1/2x11	114	51	55
1D973-32-32	51	2	-32	50,8	2x11	129	58	70

Serie de terminales aprobados para tipos de manguera:

73 | 731 | 731TC | SX35 | SX42

01 Macho NPTF fijo Rígido - Recto

SAE J476A / J516 - AGN

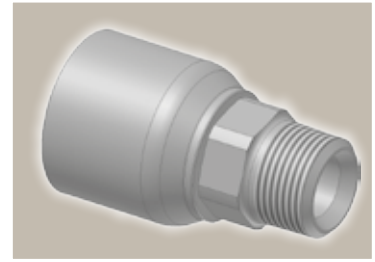
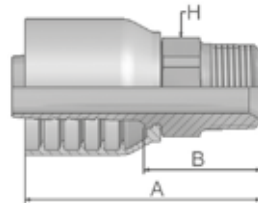

Referencia	D.I. de manguera				Rosca NPTF	A mm	B mm	H mm Pulg.
	DN	Pulg.	Tamaño	mm				
10173-12-12-SM	19	3/4	-12	19,1	3/4-14	90	42	30
10173-16-12-SM	19	3/4	-12	19,1	1-11 1/2	96	48	36
10173-16-16-SM	25	1	-16	25,4	1-11 1/2	100	50	36
10173-20-20-SM	31	1 1/4	-20	31,8	1 1/4-11 1/2	125	61	46
10173-24-24-SM	38	1 1/2	-24	38,1	1 1/2-11 1/2	124	62	50
10173-32-32	51	2	-32	50,8	2-11 1/2	141	73	2 1/2

03 Macho JIC 37° Rígido - Recto

ISO12151-5-S - AGJ

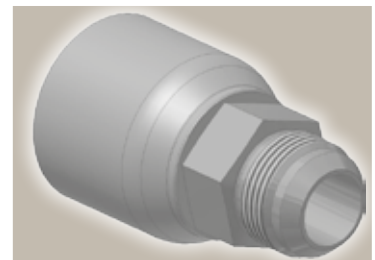
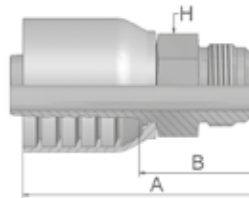

Referencia	D.I. de manguera				Rosca UNF	A mm	B mm	H mm
	DN	Pulg.	Tamaño	mm				
10373-12-12-SM	19	3/4	-12	19,1	1 1/16x12	89	41	30
10373-16-12-SM	19	3/4	-12	19,1	1 5/16x12	93	45	36
10373-16-16-SM	25	1	-16	25,4	1 5/16x12	97	47	36
10373-20-16-SM	25	1	-16	25,4	1 5/8x12	102	52	46
10373-20-20-SM	31	1 1/4	-20	31,8	1 5/8x12	118	54	46
10373-24-20-SM	31	1 1/4	-20	31,8	1 7/8x12	118	54	50
10373-24-24-SM	38	1 1/2	-24	38,1	1 7/8x12	122	59	50
10373-32-32-SM	51	2	-32	50,8	2 1/2x12	143	72	65

Serie de terminales aprobados para tipos de manguera:

73 | 731 | 731TC | SX35 | SX42

06 Hembra giratoria JIC 37° Recta

ISO12151-5-SWS – DKJ

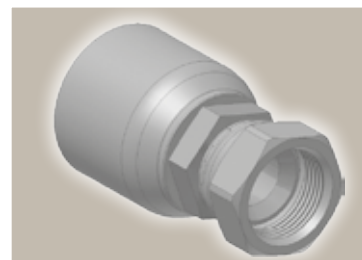
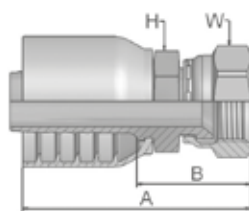

Referencia	D.I. de manguera				Rosca UNF	A mm	B mm	H		W	
	DN	Pulg.	Tamaño	mm				mm	Pulg.	mm	Pulg.
10673-12-12-SM	19	3/4	-12	19,1	1 1/16x12	93	45	30		32	
10673-16-12	19	3/4	-12	19,1	1 5/16x12	99	51	36		41	
10673-16-16-SM	25	1	-16	25,4	1 5/16x12	103	52	36		41	
10673-20-16	25	1	-16	25,4	1 5/16x12	109	59	41		50	
10673-16-20-SM	31	1 1/4	-20	31,8	1 5/16x12	116	52	46		41	
10673-20-20-SM	31	1 1/4	-20	31,8	1 5/8x12	125	61	46		50	
10673-24-20-SM	31	1 1/4	-20	31,8	1 7/8x12	130	66	50		60	
10673-24-24-SM	38	1 1/2	-24	38,1	1 7/8x12	128	66	50		60	
10673-32-24-SM	38	1 1/2	-24	38,1	2 1/2x12	138	76	65		75	
10673-32-32-SM	51	2	-32	50,8	2 1/2x12	150	79	65		75	

37 Hembra giratoria JIC 37° Codo 45°

ISO 12151-5-SWE 45° – DKJ 45°

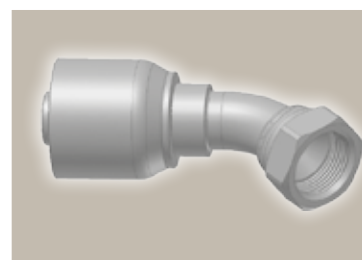
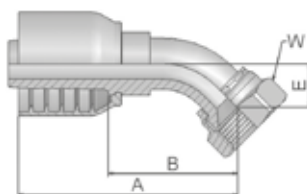

Referencia	D.I. de manguera				Rosca UNF	A mm	B mm	E mm	W mm
	DN	Pulg.	Tamaño	mm					
13773-12-12-SM	19	3/4	-12	19,1	1 1/16x12	104	56	22	32
13773-16-12-SM	19	3/4	-12	19,1	1 5/16x12	107	59	24	41
13773-16-16-SM	25	1	-16	25,4	1 5/16x12	119	69	24	41
13773-20-16-SM	25	1	-16	25,4	1 5/8x12	143	92	47	55
13773-20-20-SM	31	1 1/4	-20	31,8	1 5/8x12	171	107	47	50
13773-24-20-SM	31	1 1/4	-20	31,8	1 7/8x12	172	108	48	60
13773-24-24-SM	38	1 1/2	-24	38,1	1 7/8x12	194	132	58	60
13773-32-24-SM	38	1 1/2	-24	38,1	2 1/2x12	208	145	72	75
13773-32-32-SM	51	2	-32	50,8	2 1/2x12	251	179	72	75

Serie de terminales aprobados para tipos de manguera:

73 731 731TC SX35 SX42

39 Hembra giratoria JIC 37° Codo 90°

ISO 12151-5-SWES – DKJ 90°

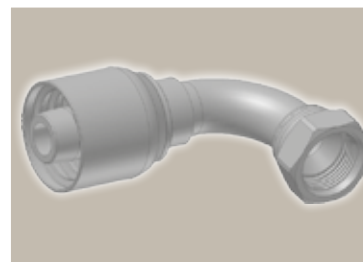
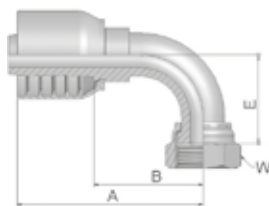

Referencia	D.I. de manguera				Rosca UNF	A mm	B mm	E mm	W mm
	DN	Pulg.	Tamaño	mm					
13973-12-12-SM	19	3/4	-12	19,1	1 1/16x12	101	53	48	32
13973-16-12-SM	19	3/4	-12	19,1	1 5/16x12	101	53	56	41
13973-16-16-SM	25	1	-16	25,4	1 5/16x12	118	67	56	41
13973-20-16-SM	25	1	-16	25,4	1 5/8x12	118	67	85	55
13973-20-20-SM	31	1 1/4	-20	31,8	1 5/8x12	150	87	85	50
13973-24-20-SM	31	1 1/4	-20	31,8	1 7/8x12	151	87	102	60
13973-24-24-SM	38	1 1/2	-24	38,1	1 7/8x12	194	119	102	60
13973-32-24-SM	38	1 1/2	-24	38,1	2 1/2x12	168	106	152	75
13973-32-32-SM	51	2	-32	50,8	2 1/2x12	229	157	152	75

Serie de terminales aprobados para tipos de manguera:

73 731 731TC SX35 SX42

15/4A Brida ISO 6162-1 Recta

ISO 12151-3-S-L – SFL
(35,0 MPa/ 5000 psi)

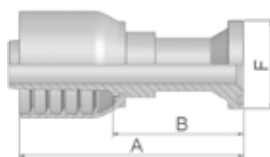

Referencia	D.I. de manguera				Terminal Pulg.	A mm	B mm	F mm
	DN	Pulg.	Tamaño	mm				
11573-12-12	19	3/4	-12	19,1	3/4	110	62	38
11573-16-12	19	3/4	-12	19,1	1	110	62	45
11573-12-16	25	1	-16	25,4	3/4	117	67	38
11573-16-16	25	1	-16	25,4	1	117	67	45
14A73-20-16	25	1	-16	25,4	1 1/4	85	34	51
11573-16-20	31	1 1/4	-20	31,8	1	133	69	45
14A73-20-20	31	1 1/4	-20	31,8	1 1/4	141	77	51
14A73-24-20	31	1 1/4	-20	31,8	1 1/2	104	40	60
14A73-20-24	38	1 1/2	-24	38,1	1 1/4	142	80	51
14A73-24-24	38	1 1/2	-24	38,1	1 1/2	166	103	60
14A73-32-24	38	1 1/2	-24	38,1	2	113	50	71
14A73-24-32	51	2	-32	50,8	1 1/2	156	84	60
14A73-32-32	51	2	-32	50,8	2	220	148	71

Las semibridas SAE se encuentran en la página 43.

Se pueden usar terminales con junta tórica estándar para temperaturas desde -40 °C hasta +105 °C.

17/4F Brida ISO 6162-1 Codo 45°

ISO 12151-3 – E45S – L – SFL 45°
(35,0 MPa/ 5000 psi)

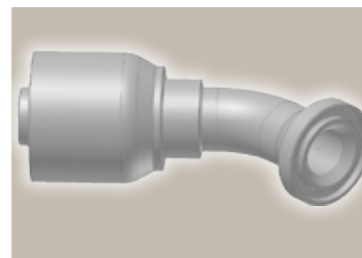
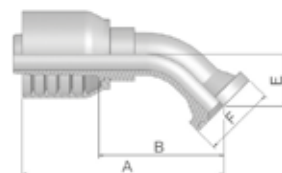

Referencia	D.I. de manguera				Terminal Pulg.	A mm	B mm	E mm	F mm
	DN	Pulg.	Tamaño	mm					
11773-12-12	19	3/4	-12	19,1	3/4	119	71	27	38
11773-16-12	19	3/4	-12	19,1	1	109	64	26	44
11773-12-16	25	1	-16	25,4	3/4	130	80	32	38
11773-16-16	25	1	-16	25,4	1	127	77	32	45
14F73-20-16	25	1	-16	25,4	1 1/4	136	85	32	51
14F73-20-20	31	1 1/4	-20	31,8	1 1/4	160	96	35	51
14F73-24-20	31	1 1/4	-20	31,8	1 1/2	162	102	38	60
14F73-24-24	38	1 1/2	-24	38,1	1 1/2	178	115	44	60
14F73-32-24	38	1 1/2	-24	38,1	2	177	114	43	71
14F73-24-32	51	2	-32	50,8	1 1/2	192	120	53	60
14F73-32-32	51	2	-32	50,8	2	224	153	62	71

Las semibridas SAE se encuentran en la página 43.

Se pueden usar terminales con junta tórica estándar para temperaturas desde -40 °C hasta +105 °C.

Serie de terminales aprobados para tipos de manguera:

73 731 731TC SX35 SX42

19/4N Brida ISO 6162-1 Codo 90°

ISO 12151-3-E-L – SFL 90°
(35,0 MPa/ 5000 psi)

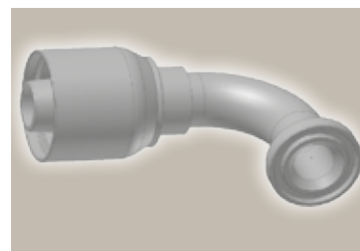
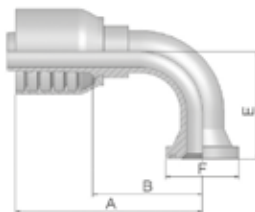

Referencia	D.I. de manguera				Terminal Pulg.	A mm	B mm	E mm	F mm
	DN	Pulg.	Tamaño	mm					
11973-12-12	19	3/4	-12	19,1	3/4	109	61	58	38
11973-16-12	19	3/4	-12	19,1	1	102	54	58	45
11973-12-16	25	1	-16	25,4	3/4	121	70	70	38
11973-16-16	25	1	-16	25,4	1	118	67	70	45
14N73-20-16	25	1	-16	25,4	1 1/4	128	78	68	51
14N73-24-16	25	1	-16	25,4	1 1/2	132	81	70	60
11973-16-20	31	1 1/4	-20	31,8	1	133	69	70	44
14N73-20-20	31	1 1/4	-20	31,8	1 1/4	155	91	90	51
14N73-24-20	31	1 1/4	-20	31,8	1 1/2	155	91	90	60
14N73-24-24	38	1 1/2	-24	38,1	1 1/2	166	103	93	60
14N73-32-24	38	1 1/2	-24	38,1	2	166	103	92	71
14N73-32-32	51	2	-32	50,8	2	220	148	133	71

Las semibridas SAE se encuentran en la página 43.

Se pueden usar terminales con junta tórica estándar para temperaturas desde -40 °C hasta +105 °C.

6A Brida ISO 6162-2 Recta

ISO 12151-3-S-S – SFS
(42,0 MPa/ 6000 psi)

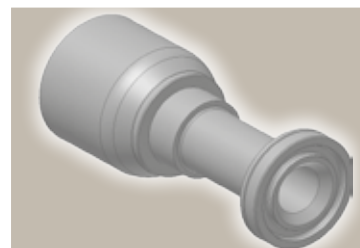
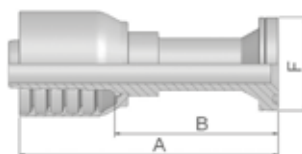

Referencia	D.I. de manguera				Terminal Pulg.	A mm	B mm	F mm
	DN	Pulg.	Tamaño	mm				
16A73-8-12	19	3/4	-12	19,1	1/2	123	75	32
16A73-12-12	19	3/4	-12	19,1	3/4	130	82	41
16A73-16-12	19	3/4	-12	19,1	1	135	87	48
16A73-20-12	19	3/4	-12	19,1	1 1/4	96	48	54
16A73-12-16	25	1	-16	25,4	3/4	124	73	41
16A73-16-16	25	1	-16	25,4	1	131	81	48
16A73-20-16	25	1	-16	25,4	1 1/4	142	91	54
16A73-16-20	31	1 1/4	-20	31,8	1	147	83	48
16A73-20-20	31	1 1/4	-20	31,8	1 1/4	149	85	54
16A73-24-20	31	1 1/4	-20	31,8	1 1/2	121	57	64
16A73-20-24	38	1 1/2	-24	38,1	1 1/4	158	96	54
16A73-24-24	38	1 1/2	-24	38,1	1 1/2	166	104	64
16A73-32-24	38	1 1/2	-24	38,1	2	129	66	79
16A73-32-32	51	2	-32	50,8	2	194	122	79

Las semibridas SAE se encuentran en la página 43.

Se pueden usar terminales con junta tórica estándar para temperaturas desde -40 °C hasta +105 °C.

Serie de terminales aprobados para tipos de manguera:

73 731 731TC SX35 SX42

6E **Brida ISO 6162-2**
Codo 30°
SFS 30°
(42,0 MPa/ 6000 psi)

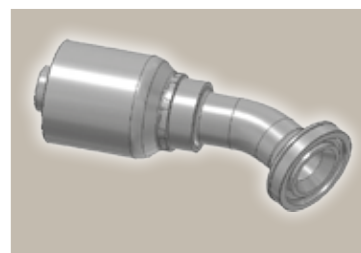
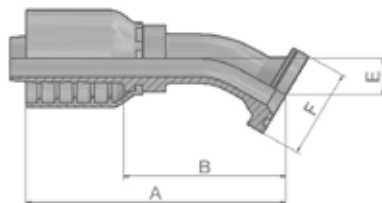

Referencia	D.I. de manguera				Terminal Pulg.	A mm	B mm	E mm	F mm
	DN	Pulg.	Tamaño	mm					
16E73-12-12-1P	19	3/4	-12	19,1	3/4	115	67	16	41
16E73-12-16-1P	25	1	-16	25,4	3/4	130	80	19	41
16E73-16-16-1P	25	1	-16	25,4	1	135	85	20	48

Las semibridas SAE se encuentran en la página 43.

Se pueden usar terminales con junta tórica estándar para temperaturas desde -40 °C hasta +105 °C.

6F **Brida ISO 6162-2**
Codo 45°
ISO 12151-3 – E45-S – SFS 45°
(42,0 MPa/ 6000 psi)

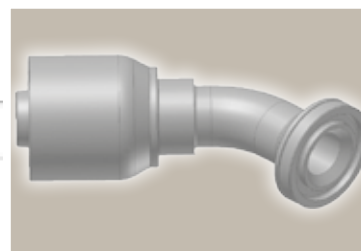
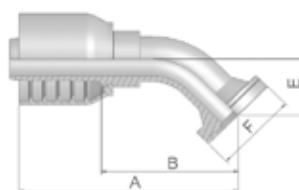

Referencia	D.I. de manguera				Terminal Pulg.	A mm	B mm	E mm	F mm
	DN	Pulg.	Tamaño	mm					
16F73-8-12	19	3/4	-12	19,1	1/2	107	59	27	32
16F73-12-12	19	3/4	-12	19,1	3/4	110	62	26	41
16F73-16-12	19	3/4	-12	19,1	1	110	62	26	48
16F73-20-12	19	3/4	-12	19,1	1 1/4	125	77	32	54
16F73-12-16	25	1	-16	25,4	3/4	123	73	32	41
16F73-16-16	25	1	-16	25,4	1	129	79	32	48
16F73-20-16	25	1	-16	25,4	1 1/4	129	79	32	54
16F73-16-20	31	1 1/4	-20	31,8	1	157	93	33	48
16F73-20-20	31	1 1/4	-20	31,8	1 1/4	163	98	38	54
16F73-24-20	31	1 1/4	-20	31,8	1 1/2	163	99	38	63
16F73-20-24	38	1 1/2	-24	38,1	1 1/4	170	107	44	54
16F73-24-24	38	1 1/2	-24	38,1	1 1/2	178	115	44	64
16F73-32-32	51	2	-32	50,8	2	230	158	56	79

Las semibridas SAE se encuentran en página 43.

Se pueden usar terminales con junta tórica estándar para temperaturas desde -40 °C hasta +105 °C.

Serie de terminales aprobados para tipos de manguera:

73 | 731 | 731TC | SX35 | SX42

6N Brida ISO 6162-2 Codo 90°

ISO 12151-3 – E-S – SFS 90°
(42,0 MPa/ 6000 psi)

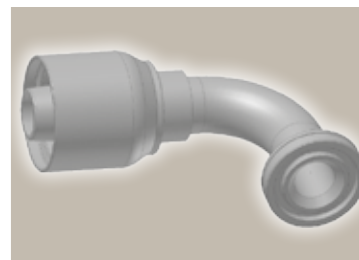
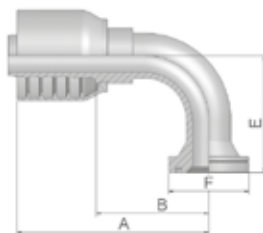

Referencia	D.I. de manguera				Terminal Pulg.	A mm	B mm	E mm	F mm
	DN	Pulg.	Tamaño	mm					
16N73-8-12	19	3/4	-12	19,1	1/2	92	44	58	32
16N73-12-12	19	3/4	-12	19,1	3/4	101	53	58	41
16N73-16-12	19	3/4	-12	19,1	1	111	63	58	48
16N73-20-12	19	3/4	-12	19,1	1 1/4	110	62	63	54
16N73-12-16	25	1	-16	25,4	3/4	109	58	70	41
16N73-16-16	25	1	-16	25,4	1	122	71	70	48
16N73-20-16	25	1	-16	25,4	1 1/4	122	71	70	54
16N73-16-20	31	1 1/4	-20	31,8	1	137	73	90	48
16N73-20-20	31	1 1/4	-20	31,8	1 1/4	172	108	71	54
16N73-24-20	31	1 1/4	-20	31,8	1 1/2	172	108	76	64
16N73-20-24	38	1 1/2	-24	38,1	1 1/4	152	90	104	54
16N73-24-24	38	1 1/2	-24	38,1	1 1/2	166	103	104	64
16N73-32-24	38	1 1/2	-24	38,1	2	166	103	104	79
16N73-24-32	51	2	-32	50,8	1 1/2	188	116	104	64
16N73-32-32	51	2	-32	50,8	2	229	157	138	79

Las semibridas SAE se encuentran en la página 43.

Se pueden usar terminales con junta tórica estándar para temperaturas desde -40 °C hasta +105 °C.

XA Brida Caterpillar® Recta

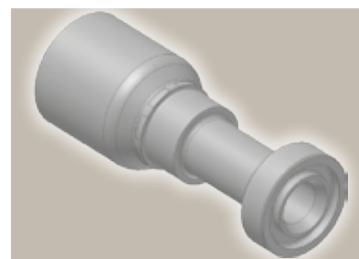
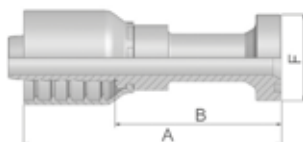

Referencia	D.I. de manguera				Terminal Pulg.	A mm	B mm	F mm
	DN	Pulg.	Tamaño	mm				
1XA73-12-12	19	3/4	-12	19,1	3/4	123	75	41
1XA73-16-12	19	3/4	-12	19,1	1	134	86	48
1XA73-16-16	25	1	-16	25,4	1	138	88	48
1XA73-20-16	25	1	-16	25,4	1 1/4	144	93	54
1XA73-20-20	31	1 1/4	-20	31,8	1 1/4	155	96	54
1XA73-24-20	31	1 1/4	-20	31,8	1 1/2	162	97	64

Se pueden usar terminales con junta tórica estándar para temperaturas desde -40 °C hasta +105 °C.

Serie de terminales aprobados para tipos de manguera:

73 | 731 | 731TC | SX35 | SX42

XF Brida Caterpillar® Codo 45°

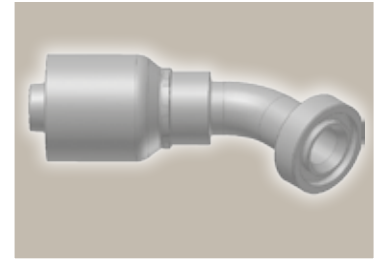
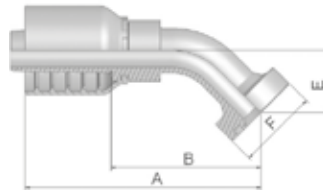

Referencia	D.I. de manguera				Terminal	A	B	E	F
	DN	Pulg.	Tamaño	mm					
1XF73-12-12	19	3/4	-12	19,1	3/4	123	75	31	41
1XF73-16-12	19	3/4	-12	19,1	1	122	74	31	48
1XF73-16-16	25	1	-16	25,4	1	139	88	36	48
1XF73-20-20	31	1 1/4	-20	31,8	1 1/4	162	98	37	54
1XF73-24-20	31	1 1/4	-20	31,8	1 1/2	182	117	36	64

Se pueden usar terminales con junta tórica estándar para temperaturas desde -40 °C hasta +105 °C.

XG Brida Caterpillar® Codo 60°

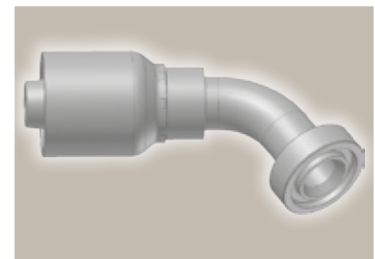
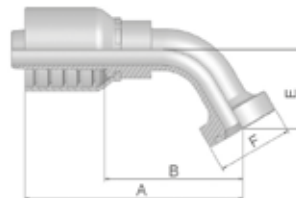

Referencia	D.I. de manguera				Terminal	A	B	E	F
	DN	Pulg.	Tamaño	mm					
1XG73-12-12	19	3/4	-12	19,1	3/4	41	138	90	42
1XG73-16-16	25	1	-16	25,4	1	48	160	109	50
1XG73-20-16	25	1	-16	25,4	1 1/4	54	153	103	48

Se pueden usar terminales con junta tórica estándar para temperaturas desde -40 °C hasta +105 °C.

Serie de terminales aprobados para tipos de manguera:

73 731 731TC SX35 SX42

XN **Brida Caterpillar®**
Codo 90°

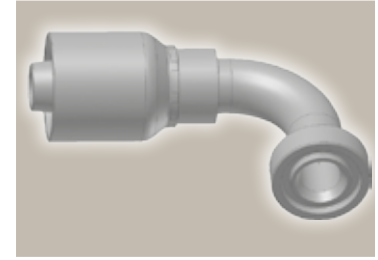
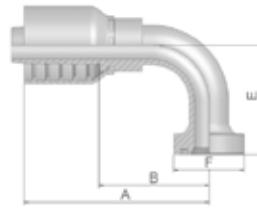

Referencia	D.I. de manguera				Terminal Pulg.	A mm	B mm	E mm	F mm
	DN	Pulg.	Tamaño	mm					
1XN73-12-12	19	3/4	-12	19,1	3/4	111	63	63	41
1XN73-16-12	19	3/4	-12	19,1	1	111	63	62	48
1XN73-16-16	25	1	-16	25,4	1	128	78	74	48
1XN73-20-16	25	1	-16	25,4	1 1/4	122	71	74	54
1XN73-20-20	31	1 1/4	-20	31,8	1 1/4	172	108	77	54

Se pueden usar terminales con junta tórica estándar para temperaturas desde -40 °C hasta +105 °C.

Serie de terminales aprobados para tipos de manguera:

73 731 731TC SX35 SX42

JC Hembra giratoria ORFS Recta - Corta

ISO 12151-1 - SWSA
SAE J516 - ORFS

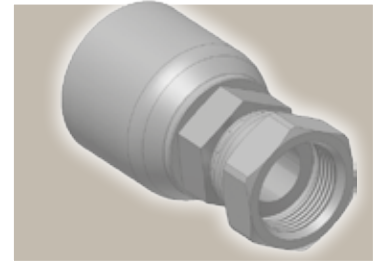
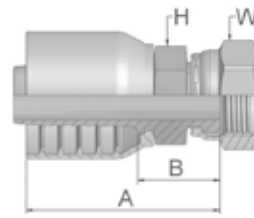

Referencia	D.I. de manguera				Rosca UNF	A mm	B mm	H mm	W mm
	DN	Pulg.	Tamaño	mm					
1JC73-12-12-SM	19	3/4	-12	19,1	1 3/16x12	81	33	30	36
1JC73-16-16-SM	25	1	-16	25,4	1 7/16x12	89	38	36	41
1JC73-20-20-SM	31	1 1/4	-20	31,8	1 11/16x12	106	42	46	50
1JC73-24-24-SM	38	1 1/2	-24	38,1	2x12	117	44	50	60

JS Hembra giratoria ORFS (Larga)

ISO 12151-1-SWSB
SAE J516 - ORFS

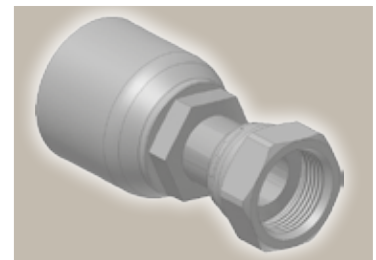
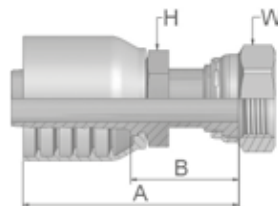

Referencia	D.I. de manguera				Rosca UNF	A mm	B mm	H mm Pulg.	W mm Pulg.
	DN	Pulg.	Tamaño	mm					
1JS73-12-12-SM	19	3/4	-12	19,1	1 3/16x12	94	46	30	36
1JS73-16-12-SM	19	3/4	-12	19,1	1 7/16x12	107	58	36	41
1JS73-16-16-SM	25	1	-16	25,4	1 7/16x12	103	52	36	41
1JS73-20-16-SM	25	1	-16	25,4	1 11/16x12	114	64	41	50
1JS73-20-20-SM	31	1 1/4	-20	31,8	1 11/16x12	117	54	46	50
1JS73-24-24-SM	38	1 1/2	-24	38,1	2x12	120	57	50	60

Serie de terminales aprobados para tipos de manguera:

73 | 731 | 731TC | SX35 | SX42

J7 Hembra giratoria ORFS Codo 45°

ISO 12151-1 – SWE 45°
SAE J516 – ORFS 45°

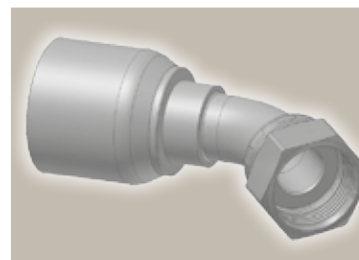
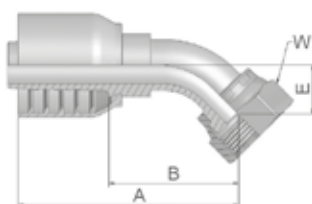

Referencia	D.I. de manguera				Rosca UNF	A mm	B mm	E mm	W mm
	DN	Pulg.	Tamaño	mm					
1J773-12-12-SM	19	3/4	-12	19,1	1 3/16x12	105	57	21	36
1J773-16-12-SM	19	3/4	-12	19,1	1 7/16x12	107	59	24	41
1J773-16-16-SM	25	1	-16	25,4	1 7/16x12	119	69	24	41
1J773-20-16-SM	25	1	-16	25,4	1 11/16x12	131	80	26	50
1J773-20-20	31	1 1/4	-20	31,8	1 11/16x12	147	83	25	7/8
1J773-20-20-SM	31	1 1/4	-20	31,8	1 11/16x12	154	90	30	50
1J773-24-20-SM	31	1 1/4	-20	31,8	2x12	164	100	40	60

J9 Hembra giratoria ORFS Codo 90° – Corto

ISO 12151-1 – SWES
SAE J516 – ORFS 90°

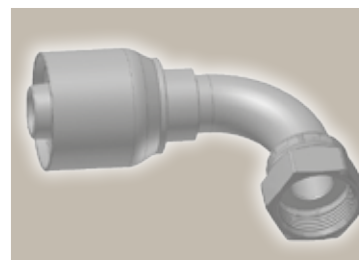
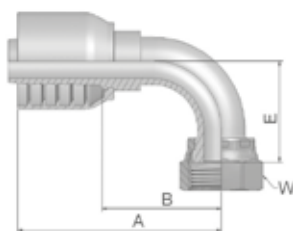





Referencia	D.I. de manguera				Rosca UNF	A mm	B mm	E mm	W	
	DN	Pulg.	Tamaño	mm					mm	Pulg.
1J973-12-12-SM	19	3/4	-12	19,1	1 3/16x12	101	53	48	36	
1J973-16-12-SM	19	3/4	-12	19,1	1 7/16x12	113	65	56	41	
1J973-16-16-SM	25	1	-16	25,4	1 7/16x12	120	70	56	41	
1J973-20-16-SM	25	1	-16	25,4	1 11/16x12	127	77	64	50	
1J973-20-20	31	1 1/4	-20	31,8	1-11/16x12	148	84	64	7/8	
1J973-20-20-SM	31	1 1/4	-20	31,8	1 11/16x12	151	87	69	50	
1J973-24-24-SM	38	1 1/2	-24	38,1	2x12	166	103	82	60	

Serie de terminales aprobados para tipos de manguera:

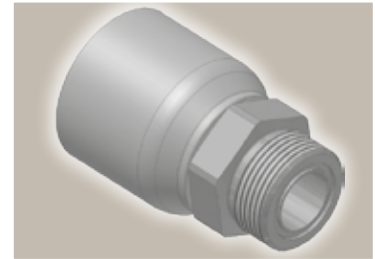
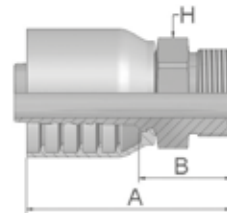
73 | 731 | 731TC | SX35 | SX42

JM Macho ORFS
ISO 12151-1-S – SAE J516



Referencia	 D.I. de manguera				 Rosca UNF	A mm	B mm	 H mm
	DN	Pulg.	Tamaño	mm				
1JM73-12-12-SM	19	3/4	-12	19,1	1 3/16x12	86	38	32
1JM73-16-12-SM	19	3/4	-12	19,1	1 7/16x12	87	39	41
1JM73-16-16-SM	25	1	-16	25,4	1 7/16x12	93	42	41
1JM73-20-16-SM	25	1	-16	25,4	1 11/16x12	89	39	46
1JM73-20-20-SM	31	1 1/4	-20	31,8	1 11/16x12	106	42	46

Los terminales JM se suministran sin junta tórica.

Serie de terminales aprobados para tipos de manguera:

73 731 731TC SX35 SX42

**FG Macho Gaz francés
Rígido
Recto (Cono 24°)**

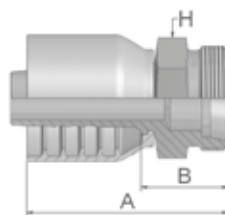

Referencia	D.I. de manguera				Rosca métrica	Tubo D.E. mm	A mm	B mm	H mm
	DN	Pulg.	Tamaño	mm					
1FG73-27-12	19	3/4	-12	19,1	M36x1,5	26,75	82	33	36
1FG73-33-16	25	1	-16	25,4	M45x1,5	33,50	91	39	46

**F2 Hembra giratoria francesa
Serie Gaz
Codo 90°**

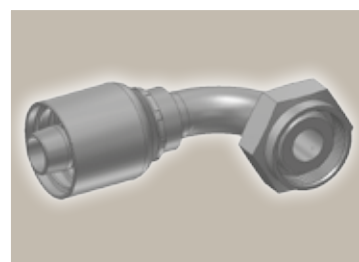
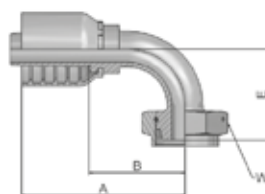





Referencia	D.I. de manguera				Rosca métrica	A mm	B mm	E mm	W mm
	DN	Pulg.	Tamaño	mm					
1F273-33-16	25	1	-16	25,4	M45x1,5	122	71	68	55

Serie de terminales aprobados para tipos de manguera:

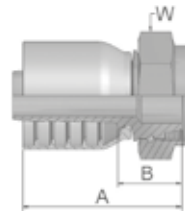
73 | 731 | 731TC | SX35 | SX42

F4 Hembra giratoria francesa Serie Gaz Recta (Asiento ovalado)



Referencia	 D.I. de manguera				 Rosca métrica	Tubo D.E. mm	A mm	B mm	 W mm
	DN	Pulg.	Tamaño	mm					
1F473-27-12	19	3/4	-12	19,1	M36x1,5	27	83	33	46
1F473-33-16	25	1	-16	25,4	M45x1,5	33	85	34	55





Serie de terminales aprobados para tipos de manguera:

73 731 731TC SX35 SX42

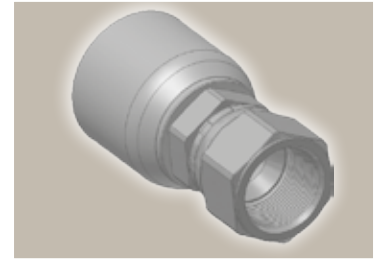
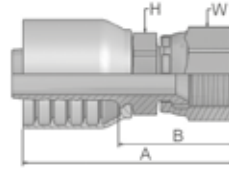
XU Hembra giratoria métrica Recta (Abocardado 30°)

JIS B8363



Referencia	 D.I. de manguera				 Rosca métrica	A mm	B mm	 H mm	 W mm
	DN	Pulg.	Tamaño	mm					
1XU73-12-12	19	3/4	-12	19,1	M30x1,5	76	28	32	36
1XU73-16-16	25	1	-16	25,4	M33x1,5	85	35	36	41

Serie de terminales aprobados para tipos de manguera:

73 731 731TC SX35 SX42

Amplia gama de racores de manguera especiales para el mercado MRO

La demanda de racores de manguera especiales forma parte de nuestro trabajo diario. Para satisfacer esta demanda con la autoridad esperada, la Hose Products Division en Europa ha ampliado su oferta habitual con racores de manguera especiales, por ejemplo de longitud de bajada extra, etc.

A continuación tiene información general sobre nuestra selección de racores de manguera especiales:

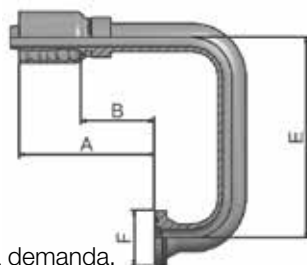

Hay disponibles más racores de manguera especiales a demanda.

Referencia	Descripción			A mm	B mm	E mm	F mm
		#_HoseID_# Módulo	#_flange_# Pulg.				
11973-12-12-SL100	Codo SAE 5000 psi 90° con longitud de bajada de 100 mm	-12	3/4	109	61	100	38
11973-12-12-SL150	Codo SAE 5000 psi 90° con longitud de bajada de 150 mm	-12	3/4	109	61	150	38
11973-12-12-SL180	Codo SAE 5000 psi 90° con longitud de bajada de 180 mm	-12	3/4	109	61	180	38
11973-16-16-SL100	Codo SAE 5000 psi 90° con longitud de bajada de 100 mm	-16	1	118	67	100	45
11973-16-16-SL150	Codo SAE 5000 psi 90° con longitud de bajada de 150 mm	-16	1	118	67	150	45
11973-16-16-SL90	Codo SAE 5000 psi 90° con longitud de bajada de 90 mm	-16	1	118	67	90	45
14N73-20-20-SL150	Codo SAE 5000 psi 90° con longitud de bajada de 150 mm	-20	1 1/4	155	91	150	51
16N73-12-12-SL100	Codo SAE 6000 psi 90° con longitud de bajada de 100 mm	-12	3/4	101	53	100	41
16N73-12-12-SL140	Codo SAE 6000 psi 90° con longitud de bajada de 140 mm	-12	3/4	101	53	140	41
16N73-12-12-SL150	Codo SAE 6000 psi 90° con longitud de bajada de 150 mm	-12	3/4	101	53	150	41
16N73-12-12-SL85	Codo SAE 6000 psi 90° con longitud de bajada de 85 mm	-12	3/4	101	53	85	41
16N73-16-12-SL100	Codo SAE 6000 psi 90° con longitud de bajada de 100 mm	-12	1	111	63	100	48
16N73-16-12-SL116	Codo SAE 6000 psi 90° con longitud de bajada de 116 mm	-12	1	111	63	116	48
16N73-16-12-SL120	Codo SAE 6000 psi 90° con longitud de bajada de 120 mm	-12	1	111	63	120	48
16N73-16-16-SL100	Codo SAE 6000 psi 90° con longitud de bajada de 100 mm	-16	1	118	67	100	48
16N73-16-16-SL110	Codo SAE 6000 psi 90° con longitud de bajada de 110 mm	-16	1	122	71	110	48
16N73-16-16-SL116	Codo SAE 6000 psi 90° con longitud de bajada de 116 mm	-16	1	128	77	116	48
16N73-16-16-SL125	Codo SAE 6000 psi 90° con longitud de bajada de 125 mm	-16	1	118	67	125	48
16N73-16-16-SL140	Codo SAE 6000 psi 90° con longitud de bajada de 140 mm	-16	1	122	71	140	48
16N73-16-16-SL175	Codo SAE 6000 psi 90° con longitud de bajada de 175 mm	-16	1	122	71	175	48
16N73-16-16SL150	Codo SAE 6000 psi 90° con longitud de bajada de 150 mm	-16	1	117	67	150	48
16N73-20-16-SL120	Codo SAE 6000 psi 90° con longitud de bajada de 120 mm	-16	1 1/4	122	71	120	54
16N73-20-16-SL160	Codo SAE 6000 psi 90° con longitud de bajada de 160 mm	-16	1 1/4	122	71	160	54
16N73-20-20-SL100	Codo SAE 6000 psi 90° con longitud de bajada de 100 mm	-20	1 1/4	155	91	100	54
16N73-20-20-SL180	Codo SAE 6000 psi 90° con longitud de bajada de 180 mm	-20	1 1/4	155	91	180	54
16N73-20-20SL145	Codo SAE 6000 psi 90° con longitud de bajada de 145 mm	-20	1 1/4	155	91	145	54
16N73-24-24-SL90	Codo SAE 6000 psi 90° con longitud de bajada de 90 mm	-24	1 1/2	166	103	90	64

Serie de terminales aprobados para tipos de manguera:

73 | 731 | 731TC | SX35 | SX42

RACORES SERIE 77



DIN – Métrica

Página Dd-1 – Dd-4

CA

Dd-1



Hembra giratoria métrica 24°
Serie ligera con junta tórica
Recta
ISO 12151-2-SWS-L – DKOL

CE

Dd-1



Hembra giratoria métrica 24°
Serie ligera con junta tórica
Codo 45°
ISO 12151-2-SWE 45°-L – DKOL 45°

CF

Dd-2



Hembra giratoria métrica 24°
Serie ligera con junta tórica
Codo 90°
ISO 12151-2-SWE-L – DKOL 90°

D0

Dd-2



Macho métrico recto 24°
Serie ligera – Recta
ISO 12151-2-S-L – CEL

C9

Dd-3



Hembra giratoria métrica 24°
Serie pesada con junta tórica
Recta
ISO 12151-2-SWS-S – DKOS

OC

Dd-3



Hembra giratoria métrica 24°
Series pesada con junta tórica
Codo 45°
ISO 12151-2 – SWE 45°-S – DKOS 45°

1C

Dd-4



Hembra giratoria métrica 24°
Serie pesada con junta tórica
Codo 90°
ISO 12151-2-SWE-S – DKOS 90°

D2

Dd-4



Macho métrico recto 24°
Serie pesada
Rígido
ISO 12151-2-S-S – CES

BSP

Página Dd-5 – Dd-6

EA

Dd-5

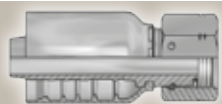

Hembra giratoria BSP
con junta tórica (Cono 60°)
BS 5200 – ISO 12151-6 – DKOR

EB

Dd-5



Hembra giratoria BSP
con junta tórica
Codo 45° (Cono 60°)
BS 5200 – ISO 12151-6 – DKOR 45°

EC

Dd-6



Hembra giratoria BSP
con junta tórica
Codo 90° (Cono 60°)
BS 5200 – ISO 12151-6 – DKOR 90°

D9

Dd-6

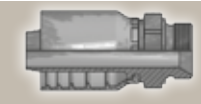

Macho cilíndrico BSP
Rígido – Recto (Cono 60°)
BS5200 – AGR

SAE

Página Dd-7 – Dd-9

01

Dd-7

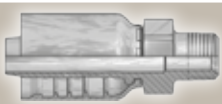

Macho NPTF fijo
Rígido – Recto
SAE J476A / J516 – AGN

03

Dd-7

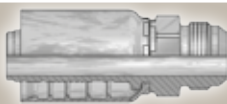

Macho JIC 37°
Rígido – Recto
ISO12151-5-S – AGJ

06

Dd-8



Hembra giratoria JIC 37°
Recta
ISO12151-5-SWS – DKJ

37

Dd-9

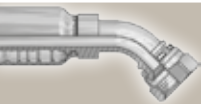

Hembra giratoria JIC 37°
Codo 45°
ISO 12151-5-SWE 45° – DKJ 45°

39

Dd-9

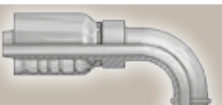

Hembra giratoria JIC 37°
Codo 90°
ISO 12151-5-SWES – DKJ 90°

Bridas

Página Dd-10 – Dd-20

<p>15/4A Dd-10 Brida ISO 6162-1 Recta ISO 12151-3-S-L – SFL (35,0 MPa/ 5000 psi)</p> 	<p>17/4F Dd-11 Brida ISO 6162-1 Codo 45° ISO 12151-3 – E45S – L – SFL 45° (35,0 MPa/ 5000 psi)</p> 	<p>19/4N Dd-12 Brida ISO 6162-1 Codo 90° ISO 12151-3-E-L – SFL 90° (35,0 MPa/ 5000 psi)</p> 	<p>6A Dd-13 Brida ISO 6162-2 Recta ISO 12151-3-S-S – SFS (42,0 MPa/ 6000 psi)</p> 
<p>6E Dd-14 Brida ISO 6162-2 Codo 30° SFS 30° (42,0 MPa/ 6000 psi)</p> 	<p>6F Dd-16 Brida ISO 6162-2 Codo 45° ISO 12151-3 – E45-S – SFS 45° (42,0 MPa/ 6000 psi)</p> 	<p>6N Dd-15 Brida ISO 6162-2 Codo 90° ISO 12151-3 – E-S – SFS 90° (42,0 MPa/ 6000 psi)</p> 	<p>X5 Dd-16 Brida Sistema completo de brida ISO 6162-1 o ISO 6162-2</p> 
<p>X7 Dd-16 Brida – Codo 45° Sistema completo de brida ISO 6162-1 or ISO 6162-2</p> 	<p>X9 Dd-17 Brida – Codo 90° Sistema completo de brida ISO 6162-1 or ISO 6162-2</p> 	<p>XA Dd-17 Brida Caterpillar® Recta</p> 	<p>XF Dd-18 Brida Caterpillar® Codo 45°</p> 
<p>XG Dd-18 Brida Caterpillar® Codo 60°</p> 	<p>XN Dd-19 Brida Caterpillar® Codo 90°</p> 	<p>K5 Dd-19 Brida Komatsu® Recta</p> 	<p>K7 Dd-20 Brida Komatsu® Codo 45°</p> 
<p>K9 Dd-20 Brida Komatsu® Codo 90°</p> 			

ORFS

Página Dd-21 – Dd-23

<p>JC Dd-21 Hembra giratoria ORFS Recta – Corta ISO 12151-1 – SWSA SAE J516 – ORFS</p> 	<p>J7 Dd-21 Hembra giratoria ORFS Codo 45° ISO 12151-1 – SWE 45° SAE J516 – ORFS 45°</p> 	<p>J9 Dd-22 Hembra giratoria ORFS Codo 90° – Corto ISO 12151-1 – SWES SAE J516 – ORFS 90°</p> 	<p>J1 Dd-22 Hembra giratoria ORFS Codo 90° – Largo ISO 12151-1 – SWEL SAE J516 – ORFS 90° L</p> 
<p>JM Dd-23 Macho ORFS ISO 12151-1-S – SAE J516</p> 			

Estándar Francés

Página Dd-24

FG
Dd-24
Macho Gaz francés Rígido Recto (Cono 24°)



CA Hembra giratoria métrica 24° Serie ligera con junta tórica Recta

ISO 12151-2-SWS-L – DKOL

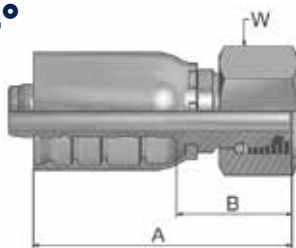

Referencia	D.I. de manguera				Rosca métrica	Tubo D.E. mm	A mm	B mm	W mm
	DN	Pulg.	Tamaño	mm					
1CA77-15-8	12	1/2	-8	12,7	M22x1,5	15	63	28	27
1CA77-18-10	16	5/8	-10	15,9	M26x1,5	18	66	27	32
1CA77-18-12	19	3/4	-12	19,1	-	18	74	28	32
1CA77-22-12	19	3/4	-12	19,1	M30x2	22	73	27	36
1CA77-22-16	25	1	-16	25,4	M30x2	22	88	33	36
1CA77-28-16	25	1	-16	25,4	M36x2	28	89	35	41
1CA77-35-20	31	1 1/4	-20	31,8	M45x2	35	100	37	50
1CA77-42-24	38	1 1/2	-24	38,1	M52x2	42	106	39	60

Se pueden usar terminales con junta tórica estándar para temperaturas desde -40 °C hasta +105 °C.

CE Hembra giratoria métrica 24° Serie ligera con junta tórica Codo 45°

ISO 12151-2-SWE 45°-L – DKOL 45°

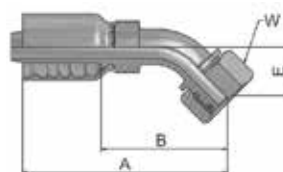

Referencia	D.I. de manguera				Rosca métrica	Tubo D.E. mm	A mm	B mm	E mm	W mm
	DN	Pulg.	Tamaño	mm						
1CE77-15-8	12	1/2	-8	12,7	M22x1,5	15	83	48	23	27
1CE77-22-12	19	3/4	-12	19,1	M30x2	22	120	74	29	36
1CE77-28-16	25	1	-16	25,4	M36x2	28	142	88	33	41
1CE77-35-20	31	1 1/4	-20	31,8	M45x2	35	162	98	37	50
1CE77-42-24	38	1 1/2	-24	38,1	M52x2	42	201	134	49	60

Se pueden usar terminales con junta tórica estándar para temperaturas desde -40 °C hasta +105 °C.

Serie de terminales aprobados para tipos de manguera, dependiendo del tamaño:

77 387 387ST 387TC 487 487ST 487TC 787 787TC 787ST 797 797TC 797ST 797RH SX42

**CF Hembra giratoria métrica 24°
Serie ligera con junta tórica
Codo 90°**

ISO 12151-2-SWE-L – DKOL 90°

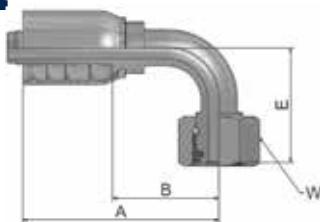

Referencia	D.I. de manguera				Rosca métrica	Tubo D.E. mm	A mm	B mm	E mm	W mm
	DN	Pulg.	Tamaño	mm						
1CF77-15-8	12	1/2	-8	12,7	M22x1,5	15	76	41	44	27
1CF77-18-10	16	5/8	-10	15,9	M26x1,5	18	92	53	49	32
1CF77-18-12	19	3/4	-12	19,1	M26x1,5	18	108	62	56	32
1CF77-22-12	19	3/4	-12	19,1	M30x2	22	108	62	59	36
1CF77-28-16	25	1	-16	25,4	M36x2	28	131	77	69	41
1CF77-35-20	31	1 1/4	-20	31,8	M45x2	35	151	87	79	50
1CF77-42-24	38	1 1/2	-24	38,1	M52x2	42	179	112	101	60

Se pueden usar terminales con junta tórica estándar para temperaturas desde -40 °C hasta +105 °C.

**DO Macho métrico recto 24°
Serie ligera – Recta**

ISO 12151-2-S-L – CEL

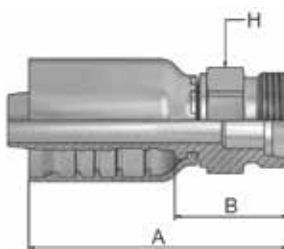

Referencia	D.I. de manguera				Rosca métrica	A mm	B mm	H mm
	DN	Pulg.	Tamaño	mm				
1D077-15-8	12	1/2	-8	12,7	M22x1,5	61	27	22
1D077-18-10	16	5/8	-10	15,9	M26x1,5	68	30	27
1D077-22-12	19	3/4	-12	19,1	M30x2	82	36	30
1D077-28-16	25	1	-16	25,4	M36x2	92	38	36

Serie de terminales aprobados para tipos de manguera, dependiendo del tamaño:

77 387 387ST 387TC 487 487ST 487TC 787 787TC 787ST 797 797TC 797ST 797RH SX42

C9 Hembra giratoria métrica 24° Serie pesada con junta tórica Recta

ISO 12151-2-SWS-S – DKOS

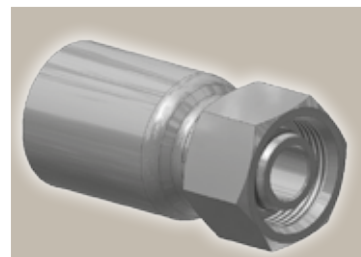
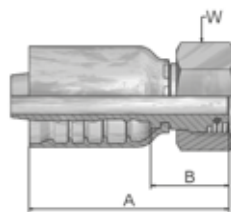

Referencia	D.I. de manguera				Rosca métrica	A mm	B mm	W mm
	DN	Pulg.	Tamaño	mm				
1C977-12-8	12	1/2	-8	12,7	M20x1,5	61	26	24
1C977-16-8	12	1/2	-8	12,7	M24x1,5	60	25	30
1C977-16-10	16	5/8	-10	15,9	M24x1,5	67	28	30
1C977-20-10	16	5/8	-10	15,9	M30x2	67	28	36
1C977-20-12	19	3/4	-12	19,1	M30x2	76	30	36
1C977-25-12	19	3/4	-12	19,1	M36x2	76,6	30,6	46
1C977-25-12-SW41	19	3/4	-12	19,1	M36x2	77	31	41
1C977-30-12	19	3/4	-12	19,1	M42x2	83	37	50
1C977-25-16	25	1	-16	25,4	M36x2	86	35	46
1C977-30-16	25	1	-16	25,4	M42x2	89	35	50
1C977-30-20	31	1 1/4	-20	31,8	M42x2	102	39	50
1C977-38-20	31	1 1/4	-20	31,8	M52x2	100	36	60
1C977-38-24	38	1 1/2	-24	38,1	M52x2	106	39	60

Se pueden usar terminales con junta tórica estándar para temperaturas desde -40 °C hasta +105 °C.

OC Hembra giratoria métrica 24° Series pesada con junta tórica Codo 45°

ISO 12151-2 – SWE 45°-S – DKOS 45°

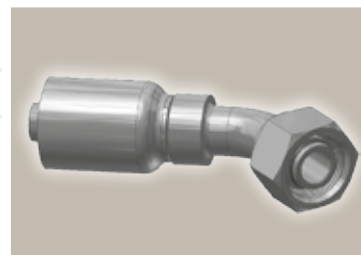
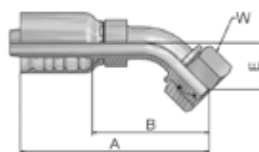

Referencia	D.I. de manguera				Rosca métrica	A mm	B mm	E mm	W mm
	DN	Pulg.	Tamaño	mm					
10C77-16-8	12	1/2	-8	12,7	M24x1,5	83	49	24	30
10C77-12-10	16	5/8	-10	15,9	M20x1,5	105	66	26	24
10C77-16-10	16	5/8	-10	15,9	M24x1,5	111	64	24	30
10C77-20-10	16	5/8	-10	15,9	M30x2	107	68	28	36
10C77-20-12	19	3/4	-12	19,1	M30x2	120	74	30	36
10C77-25-12	19	3/4	-12	19,1	M36x2	119	73	29	46
10C77-25-12-SW41	19	3/4	-12	19,1	M36x2	119	73	29	41
10C77-30-12	19	3/4	-12	19,1	M42x2	121	75	30	50
10C77-25-16	25	1	-16	25,4	M36x2	142	88	33	46
10C77-30-16	25	1	-16	25,4	M42x2	142	88	33	50
10C77-30-20	31	1 1/4	-20	31,8	M42x2	155	91	34	50
10C77-38-20	31	1 1/4	-20	31,8	M52x2	161	97	37	60
10C77-38-24	38	1 1/2	-24	38,1	M52x2	195	128	49	60

Se pueden usar terminales con junta tórica estándar para temperaturas desde -40 °C hasta +105 °C.

Serie de terminales aprobados para tipos de manguera, dependiendo del tamaño:

77 387 387ST 387TC 487 487ST 487TC 787 787TC 787ST 797 797TC 797ST 797RH SX42

1C Hembra giratoria métrica 24° Serie pesada con junta tórica Codo 90°

ISO 12151-2-SWE-S – DKOS 90°

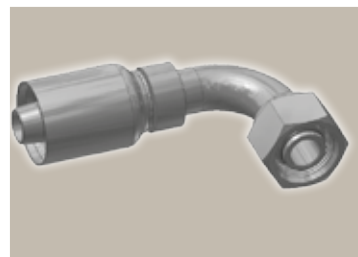
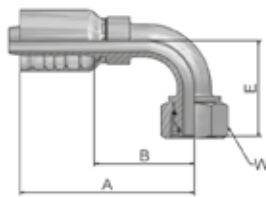

Referencia	D.I. de manguera				Rosca métrica	A mm	B mm	E mm	W mm
	DN	Pulg.	Tamaño	mm					
11C77-16-8	12	1/2	-8	12,7	M24x1,5	77	42	45	30
11C77-16-10	16	5/8	-10	15,9	M24x1,5	92	53	45	30
11C77-20-10	16	5/8	-10	15,9	M30x2	92	53	53	36
11C77-20-12	19	3/4	-12	19,1	M30x2	108	62	60	36
11C77-25-12	19	3/4	-12	19,1	M36x2	108	62	58,5	46
11C77-25-12-SW41	19	3/4	-12	19,1	M36x2	108	62	59	41
11C77-30-12	19	3/4	-12	19,1	M42x2	108	62	61	50
11C77-25-16	25	1	-16	25,4	M36x2	131	77	69	46
11C77-30-16	25	1	-16	25,4	M42x2	131	77	69	50
11C77-30-20	31	1 1/4	-20	31,8	M42x2	145	82	73	50
11C77-38-20	31	1 1/4	-20	31,8	M52x2	151	87	78	60
11C77-38-24	38	1 1/2	-24	38,1	M52x2	179	112	101	60

Se pueden usar terminales con junta tórica estándar para temperaturas desde -40 °C hasta +105 °C.

D2 Macho métrico recto 24° Serie pesada Rígido

ISO 12151-2-S-S – CES

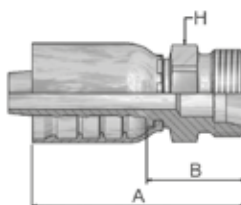

Referencia	D.I. de manguera				Rosca métrica	A mm	B mm	H mm
	DN	Pulg.	Tamaño	mm				
1D277-16-8	12	1/2	-8	12,7	M24x1,5	64	30	24
1D277-16-10	16	5/8	-10	15,9	M24x1,5	69	30	24
1D277-20-10	16	5/8	-10	15,9	M30x2	72	34	30
1D277-20-12	19	3/4	-12	19,1	M30x2	84	38	30
1D277-25-12	19	3/4	-12	19,1	M36x2	86	40	36
1D277-25-16	25	1	-16	25,4	M36x2	96	42	36
1D277-30-16	25	1	-16	25,4	M42x2	99	45	46
1D277-30-20	31	1 1/4	-20	31,8	M42x2	110	47	46
1D277-38-20	31	1 1/4	-20	31,8	M52x2	114	51	55
1D277-38-24	38	1 1/2	-24	38,1	M52x2	120	53	55

Serie de terminales aprobados para tipos de manguera, dependiendo del tamaño:

77 387 387ST 387TC 487 487ST 487TC 787 787TC 787ST 797 797TC 797ST 797RH SX42

EA Hembra giratoria BSP con junta tórica (Cono 60°)

BS 5200 – ISO 12151-6 – DKOR

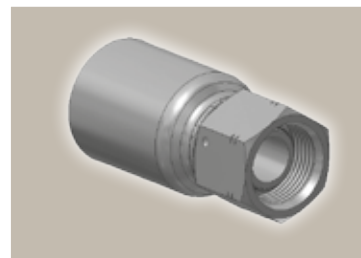
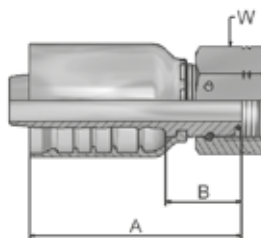

Referencia	D.I. de manguera				Rosca BSP	A mm	B mm	W mm
	DN	Pulg.	Tamaño	mm				
1EA77-8-8	12	1/2	-8	12,7	1/2x14	58	23	27
1EA77-10-10	16	5/8	-10	15,9	5/8x14	62	23	30
1EA77-12-10	16	5/8	-10	15,9	3/4x14	63	24	32
1EA77-12-12	19	3/4	-12	19,1	3/4x14	72	26	32
1EA77-16-12	19	3/4	-12	19,1	1x11	82	36	41
1EA77-12-16	25	1	-16	25,4	3/4x14	83	29	32
1EA77-16-16	25	1	-16	25,4	1x11	90	36	41
1EA77-20-20	31	1 1/4	-20	31,8	1 1/4x11	96	33	50
1EA77-24-24	38	1 1/2	-24	38,1	1 1/2	103	36	55
1EA77-32-32	51	2	-32	50,8	2	118	40	70

Se pueden usar terminales con junta tórica estándar para temperaturas desde -40 °C hasta +105 °C.

EB Hembra giratoria BSP con junta tórica Codo 45° (Cono 60°)

BS 5200 – ISO 12151-6 – DKOR 45°

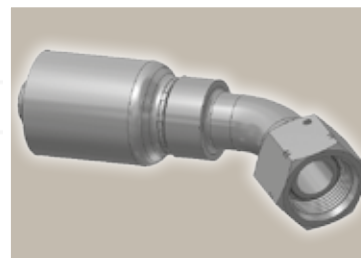
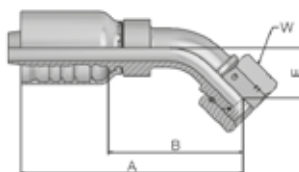

Referencia	D.I. de manguera				Rosca BSP	A mm	B mm	E mm	W mm
	DN	Pulg.	Tamaño	mm					
1EB77-8-8	12	1/2	-8	12,7	1/2x14	80	45	20	27
1EB77-10-10	16	5/8	-10	15,9	5/8x14	101	62	22	30
1EB77-12-10	16	5/8	-10	15,9	3/4x14	103	64	24	32
1EB77-12-12	19	3/4	-12	19,1	3/4x14	117	71	27	32
1EB77-16-12	19	3/4	-12	19,1	1x11	120	74	29	41
1EB77-16-16	25	1	-16	25,4	1x11	144	90	35	41
1EB77-20-20	31	1 1/4	-20	31,8	1 1/4x11	159	95	35	50
1EB77-24-24	38	1 1/2	-24	38,1	1 1/2	196	129	50	55
1EB77-32-32	51	2	-32	50,8	2	255	178	86	70

Se pueden usar terminales con junta tórica estándar para temperaturas desde -40 °C hasta +105 °C.

Serie de terminales aprobados para tipos de manguera, dependiendo del tamaño:

77 387 387ST 387TC 487 487ST 487TC 787 787TC 787ST 797 797TC 797ST 797RH SX42

EC Hembra giratoria BSP con junta tórica Codo 90° (Cono 60°)

BS 5200 – ISO 12151-6 – DKOR 90°

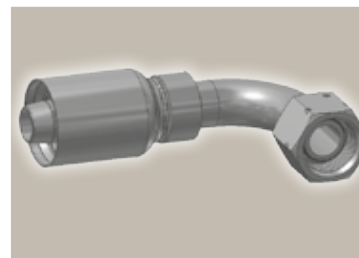
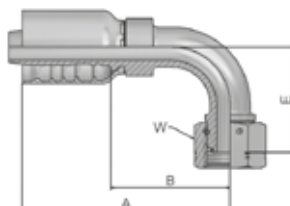

Referencia	D.I. de manguera				Rosca BSP	A mm	B mm	E mm	W mm
	DN	Pulg.	Tamaño	mm					
1EC77-8-8	12	1/2	-8	12,7	1/2x14	76	41	40	27
1EC77-10-10	16	5/8	-10	15,9	5/8x14	92	53	44	30
1EC77-12-10	16	5/8	-10	15,9	3/4x14	92	53	47	32
1EC77-12-12	19	3/4	-12	19,1	3/4x14	108	62	55	32
1EC77-16-12	19	3/4	-12	19,1	1x11	108	62	59	41
1EC77-16-16	25	1	-16	25,4	1x11	131	77	72	41
1EC77-20-20	31	1 1/4	-20	31,8	1 1/4x11	151	87	75	50
1EC77-24-24	38	1 1/2	-24	38,1	1 1/2	179	112	103	55
1EC77-32-32	51	2	-32	50,8	2	236	159	150	70

Se pueden usar terminales con junta tórica estándar para temperaturas desde -40 °C hasta +105 °C.

D9 Macho cilíndrico BSP Rígido – Recto (Cono 60°)

BS5200 – AGR

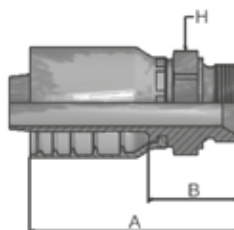

Referencia	D.I. de manguera				Rosca BSP	A mm	B mm	H mm
	DN	Pulg.	Tamaño	mm				
1D977-8-8	12	1/2	-8	12,7	1/2x14	68	33	27
1D977-10-10	16	5/8	-10	15,9	5/8x14	74	36	30
1D977-12-12	19	3/4	-12	19,1	3/4x14	87	41	32
1D977-16-12	19	3/4	-12	19,1	1x11	91	45	41
1D977-16-16	25	1	-16	25,4	1x11	91	45	41
1D977-20-16	25	1	-16	25,4	1 1/4x11	103	49	50
1D977-20-20	31	1 1/4	-20	31,8	1 1/4x11	113	50	50
1D977-24-24	38	1 1/2	-24	38,1	1 1/2x11	124	57	55

Serie de terminales aprobados para tipos de manguera, dependiendo del tamaño:

77 | 387 | 387ST | 387TC | 487 | 487ST | 487TC | 787 | 787TC | 787ST | 797 | 797TC | 797ST | 797RH | SX42

01 Macho NPTF fijo Rígido – Recto

SAE J476A / J516 – AGN

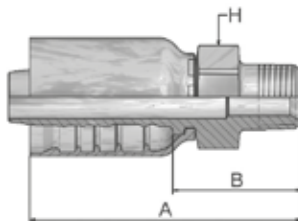

Referencia	D.I. de manguera				Rosca NPTF	A mm	B mm	H mm
	DN	Pulg.	Tamaño	mm				
10177-8-8	12	1/2	-8	12,7	1/2-14	69	35	22
10177-8-12	19	3/4	-12	19,1	1/2-14	87	41	30
10177-12-12	19	3/4	-12	19,1	3/4-14	87	41	30
10177-16-16	25	1	-16	25,4	1-11 1/2	103	49	36
10177-20-20	31	1 1/4	-20	31,8	1 1/4-11 1/2	116	53	46
10177-24-24	38	1 1/2	-24	38,1	1 1/2-11 1/2	124	57	50
10177-32-32	51	2	-32	50,8	2-11 1/2	143	66	65

03 Macho JIC 37° Rígido – Recto

ISO12151-5-S – AGJ

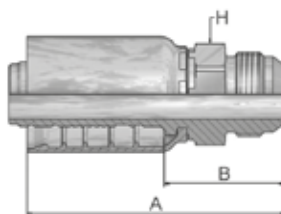

Referencia	D.I. de manguera				Rosca UNF	A mm	B mm	H mm
	DN	Pulg.	Tamaño	mm				
10377-8-8	12	1/2	-8	12,7	3/4x16	66,45	32	22
10377-10-8	12	1/2	-8	12,7	7/8x14	69	34	24
10377-12-8	12	1/2	-8	12,7	1 1/16x12	77	42	27
10377-10-10	16	5/8	-10	15,9	7/8x14	76	38	24
10377-12-10	16	5/8	-10	15,9	1 1/16x12	82	43	30
10377-10-12	19	3/4	-12	19,1	7/8x14	87	41	30
10377-12-12	19	3/4	-12	19,1	1 1/16x12	89	43	30
10377-16-12	19	3/4	-12	19,1	1 5/16x12	92	46	36
10377-16-16	25	1	-16	25,4	1 5/16x12	101,4	47	36
10377-20-16	25	1	-16	25,4	1 5/8x12	110	56	50
10377-20-20	31	1 1/4	-20	31,8	1 5/8x12	118	55	50
10377-32-32	51	2	-32	50,8	2 1/2x12	148	71	65

Serie de terminales aprobados para tipos de manguera, dependiendo del tamaño:

77 387 387ST 387TC 487 487ST 487TC 787 787TC 787ST 797 797TC 797ST 797RH SX42

06 Hembra giratoria JIC 37° Recta

ISO12151-5-SWS – DKJ

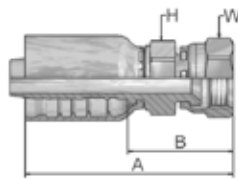

Referencia	D.I. de manguera				Rosca UNF	A mm	B mm	H mm	W mm
	DN	Pulg.	Tamaño	mm					
10677-8-8	12	1/2	-8	12,7	3/4x16	71	37	22	22
10677-10-8	12	1/2	-8	12,7	7/8x14	74	39	22	27
10677-12-8	12	1/2	-8	12,7	1 1/16x12	80	46	30	32
10677-10-10	16	5/8	-10	15,9	7/8x14	81	42	24	27
10677-12-10	16	5/8	-10	15,9	1 1/16x12	84	45	30	32
10677-10-12	19	3/4	-12	19,1	7/8x14	92	46	30	27
10677-12-12	19	3/4	-12	19,1	1 1/16x12	94	48	30	32
10677-14-12	19	3/4	-12	19,1	1 3/16x12	99	53	36	36
10677-16-12	19	3/4	-12	19,1	1 5/16x12	99	53	36	41
10677-12-16	25	1	-16	25,4	1 1/16x12	102	48	36	32
10677-16-16	25	1	-16	25,4	1 5/16x12	106	52	36	41
10677-20-16	25	1	-16	25,4	1 5/8x12	109	55	41	50
10677-16-20	31	1 1/4	-20	31,8	1 5/16x12	120	57	46	41
10677-20-20	31	1 1/4	-20	31,8	1 5/8 12	124	60	46	50
10677-24-20	31	1 1/4	-20	31,8	1 7/8x12	108	44	50	60
10677-24-24	38	1 1/2	-24	38,1	1 7/8x12	136	69	50	60
10677-32-32	51	2	-32	50,8	2 1/2x12	160	83	65	75

Serie de terminales aprobados para tipos de manguera, dependiendo del tamaño:

77 387 387ST 387TC 487 487ST 487TC 787 787TC 787ST 797 797TC 797ST 797RH SX42

37 Hembra giratoria JIC 37° Codo 45°

ISO 12151-5-SWE 45° – DKJ 45°

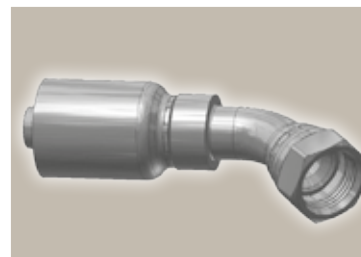
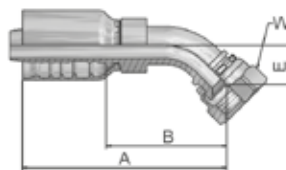

Referencia	D.I. de manguera				Rosca UNF	A mm	B mm	E mm	W mm
	DN	Pulg.	Tamaño	mm					
13777-8-8	12	1/2	-8	12,7	3/4x16	73	38	15	22
13777-10-8	12	1/2	-8	12,7	7/8x14	76	41	16	27
13777-12-8	12	1/2	-8	12,7	1 1/16x12	79	44	21	32
13777-10-10	16	5/8	-10	15,9	7/8x14	93	54	16	27
13777-12-10	16	5/8	-10	15,9	1 1/16x12	100	61	21	32
13777-10-12	19	3/4	-12	19,1	7/8x14	102	56	16	27
13777-12-12	19	3/4	-12	19,1	1 1/16x12	111	65	21	32
13777-16-12	19	3/4	-12	19,1	1 5/16x12	114	68	24	41
13777-16-16	25	1	-16	25,4	1 5/16x12	133	79	24	41
13777-20-20	31	1 1/4	-20	31,8	1 5/8x12	153	90	32	50
13777-24-24	38	1 1/2	-24	38,1	1 7/8x12	201	134	58	60
13777-32-32	51	2	-32	50,8	2 1/2x12	258	181	72	75

39 Hembra giratoria JIC 37° Codo 90°

ISO 12151-5-SWES – DKJ 90°

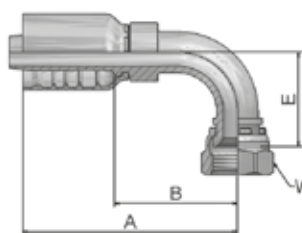

Referencia	D.I. de manguera				Rosca UNF	A mm	B mm	E mm	W mm
	DN	Pulg.	Tamaño	mm					
13977-8-8	12	1/2	-8	12,7	3/4x16	71	36	29	22
13977-10-8	12	1/2	-8	12,7	7/8x14	76	41	32	27
13977-12-8	12	1/2	-8	12,7	1 1/16x12	76	41	48	32
13977-10-10	16	5/8	-10	15,9	7/8x14	88	50	33	27
13977-12-10	16	5/8	-10	15,9	1 1/16x12	92	53	48	32
13977-10-12	19	3/4	-12	19,1	7/8x14	97	51	33	27
13977-12-12	19	3/4	-12	19,1	1 1/16x12	108	62	48	32
13977-16-12	19	3/4	-12	19,1	1 5/16x12	108	62	56	41
13977-16-16	25	1	-16	25,4	1 5/16x12	131	77	74	41
13977-20-20	31	1 1/4	-20	31,8	1 5/8x12	148	84	78	50
13977-24-24	38	1 1/2	-24	38,1	1 7/8x12	175	108	102	60
13977-32-32	51	2	-32	50,8	2 1/2x12	236	159	152	75

Serie de terminales aprobados para tipos de manguera, dependiendo del tamaño:

77 387 387ST 387TC 487 487ST 487TC 787 787TC 787ST 797 797TC 797ST 797RH SX42

15/4A Brida ISO 6162-1 Recta

ISO 12151-3-S-L – SFL
(35,0 MPa/ 5000 psi)

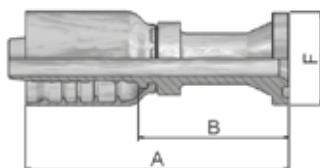

Referencia	D.I. de manguera				Terminal Pulg.	A mm	B mm	F mm
	DN	Pulg.	Tamaño	mm				
11577-8-8	12	1/2	-8	12,7	1/2	90	55	30
11577-12-8	12	1/2	-8	12,7	3/4	67	33	38
11577-10-10	16	5/8	-10	15,9	5/8	99	60	34
11577-12-10	16	5/8	-10	15,9	3/4	75	36	38
11577-12-12	19	3/4	-12	19,1	3/4	107	62	38
11577-16-12	19	3/4	-12	19,1	1	88	42	45
11577-16-16	25	1	-16	25,4	1	119	65	45
14A77-20-16	25	1	-16	25,4	1 1/4	90	36	51
11577-16-20	31	1 1/4	-20	31,8	1	130	66	45
14A77-20-20	31	1 1/4	-20	31,8	1 1/4	138	74	51
14A77-24-20	31	1 1/4	-20	31,8	1 1/2	100	37	60
14A77-20-24	38	1 1/2	-24	38,1	1 1/4	146	79	51
14A77-24-24	38	1 1/2	-24	38,1	1 1/2	140	73	60
14A77-32-24	38	1 1/2	-24	38,1	2	117	50	71
14A77-32-32	51	2	-32	50,8	2	163	86	71

Las semibridas SAE se encuentran en la página 43.

Se pueden usar terminales con junta tórica estándar para temperaturas desde -40 °C hasta +105 °C.

Serie de terminales aprobados para tipos de manguera, dependiendo del tamaño:

77 | 387 | 387ST | 387TC | 487 | 487ST | 487TC | 787 | 787TC | 787ST | 797 | 797TC | 797ST | 797RH | SX42

17/4F Brida ISO 6162-1 Codo 45°

ISO 12151-3 – E45S – L – SFL 45°
(35,0 MPa/ 5000 psi)

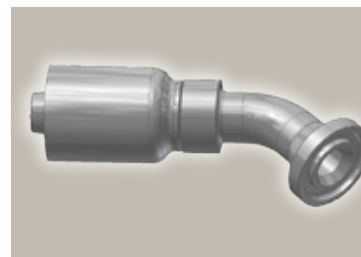
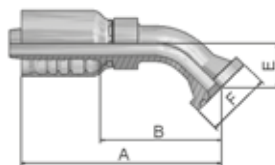

Referencia	D.I. de manguera				Terminal	A	B	E	F
	DN	Pulg.	Tamaño	mm					
11777-8-8	12	1/2	-8	12,7	1/2	79	45	20	30
11777-12-8	12	1/2	-8	12,7	3/4	81	47	22	38
11777-10-10	16	5/8	-10	15,9	5/8	103	64	24	34
11777-12-12	19	3/4	-12	19,1	3/4	116	70	26	38
11777-16-12	19	3/4	-12	19,1	1	116	70	26	45
11777-16-16	25	1	-16	25,4	1	141	87	32	45
14F77-20-16	25	1	-16	25,4	1 1/4	141	87	32	51
14F77-20-20	31	1 1/4	-20	31,8	1 1/4	162	99	38	51
14F77-24-20	31	1 1/4	-20	31,8	1 1/2	162	99	38	60
14F77-24-24	38	1 1/2	-24	38,1	1 1/2	187	120	44	60
14F77-32-24	38	1 1/2	-24	38,1	2	182	115	44	71
14F77-32-32	51	2	-32	50,8	2	211	134	56	71

Se pueden usar terminales con junta tórica estándar para temperaturas desde -40 °C hasta +105 °C.

Serie de terminales aprobados para **tipos de manguera**, dependiendo del tamaño:

77 387 387ST 387TC 487 487ST 487TC 787 787TC 787ST 797 797TC 797ST 797RH SX42

19/4N Brida ISO 6162-1 Codo 90°

ISO 12151-3-E-L – SFL 90°
(35,0 MPa/ 5000 psi)

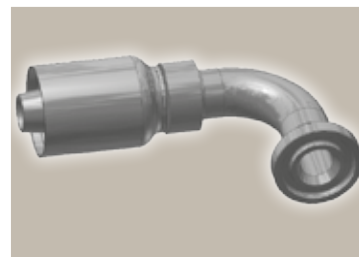
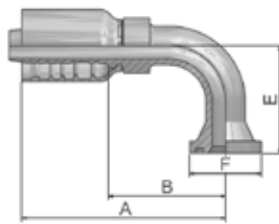

Referencia	D.I. de manguera				Terminal Pulg.	A mm	B mm	E mm	F mm
	DN	Pulg.	Tamaño	mm					
11977-8-8	12	1/2	-8	12,7	1/2	76	41	41	30
11977-12-8	12	1/2	-8	12,7	3/4	80	45	42	38
11977-10-10	16	5/8	-10	15,9	5/8	92	53	53	34
11977-12-12	19	3/4	-12	19,1	3/4	108	62	58	38
11977-16-12	19	3/4	-12	19,1	1	108	62	58	45
11977-16-16	25	1	-16	25,4	1	131	77	70	45
14N77-20-16	25	1	-16	25,4	1 1/4	131	77	69	51
11977-16-20	31	1 1/4	-20	31,8	1	151	87	90	45
14N77-20-20	31	1 1/4	-20	31,8	1 1/4	151	87	90	51
14N77-24-20	31	1 1/4	-20	31,8	1 1/2	151	87	90	60
14N77-24-24	38	1 1/2	-24	38,1	1 1/2	175	108	104	60
14N77-32-24	38	1 1/2	-24	38,1	2	175	108	104	71
14N77-32-32	51	2	-32	50,8	2	206	129	138	71

Se pueden usar terminales con junta tórica estándar para temperaturas desde -40 °C hasta +105 °C.



Serie de terminales aprobados para **tipos de manguera**, dependiendo del tamaño:

77 387 387ST 387TC 487 487ST 487TC 787 787TC 787ST 797 797TC 797ST 797RH SX42

6A Brida ISO 6162-2 Recta

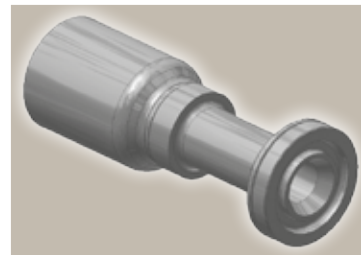
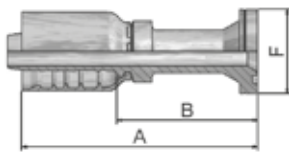
ISO 12151-3-S-S – SFS
(42,0 MPa/ 6000 psi)



Referencia	 D.I. de manguera				 Terminal	A mm	B mm	F mm
	DN	Pulg.	Tamaño	mm	Pulg.			
16A77-8-8	12	1/2	-8	12,7	1/2	89	55	32
16A77-12-8	12	1/2	-8	12,7	3/4	69,4	34,75	41
16A77-12-10	16	5/8	-10	15,9	3/4	75	36	41
16A77-16-10	16	5/8	-10	15,9	1	80	41	48
16A77-8-12	19	3/4	-12	19,1	1/2	106	60	32
16A77-12-12	19	3/4	-12	19,1	3/4	114,2	68,2	41
16A77-16-12	19	3/4	-12	19,1	1	88,2	42	48
16A77-20-12	19	3/4	-12	19,1	1 1/4	93	47	54
16A77-12-16	25	1	-16	25,4	3/4	126	72	41
16A77-16-16	25	1	-16	25,4	1	113	59	48
16A77-20-16	25	1	-16	25,4	1 1/4	103	49	54
16A77-16-20	31	1 1/4	-20	31,8	1	145	82	48
16A77-20-20	31	1 1/4	-20	31,8	1 1/4	146	82	54
16A77-24-20	31	1 1/4	-20	31,8	1 1/2	118	55	64
16A77-20-24	38	1 1/2	-24	38,1	1 1/4	154	87	54
16A77-24-24	38	1 1/2	-24	38,1	1 1/2	162	96	64
16A77-32-24	38	1 1/2	-24	38,1	2	133	66	79
16A77-32-32	51	2	-32	50,8	2	183	105	79

Se pueden usar terminales con junta tórica estándar para temperaturas desde -40 °C hasta +105 °C.

Serie de terminales aprobados para **tipos de manguera**, dependiendo del tamaño:

77 387 387ST 387TC 487 487ST 487TC 787 787TC 787ST 797 797TC 797ST 797RH SX42

6E Brida ISO 6162-2 Codo 30°

SFS 30°
(42,0 MPa/ 6000 psi)

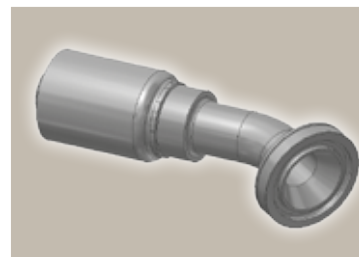
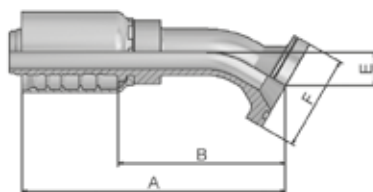

Referencia	D.I. de manguera				Terminal	A	B	E	F
	DN	Pulg.	Tamaño	mm					
16E77-12-12	19	3/4	-12	19,1	3/4	121	75	16	41
16E77-16-12	19	3/4	-12	19,1	1	122	76	16	48
16E77-16-16	25	1	-16	25,4	1	136	82	19	48
16E77-20-16	25	1	-16	25,4	1 1/4	149	95	19	54
16E77-20-20	31	1 1/4	-20	31,8	1 1/4	170	106	24	54
16E77-24-24	38	1 1/2	-24	38,1	1 1/2	190	123	30	64
16E77-32-32	51	2	-32	50,8	2	223	145	32	79

Se pueden usar terminales con junta tórica estándar para temperaturas desde -40 °C hasta +105 °C.

6F Brida ISO 6162-2 Codo 45°

ISO 12151-3 – E45-S – SFS 45°
(42,0 MPa/ 6000 psi)

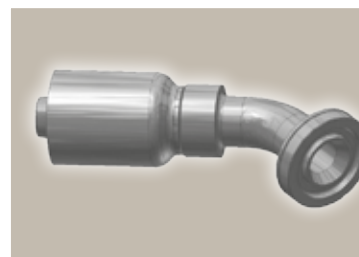
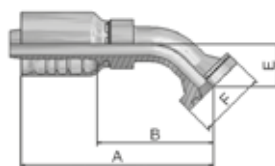

Referencia	D.I. de manguera				Terminal	A	B	E	F
	DN	Pulg.	Tamaño	mm					
16F77-8-8	12	1/2	-8	12,7	1/2	79	44	19	32
16F77-12-8	12	1/2	-8	12,7	3/4	85,8	51	26	41
16F77-8-10	16	5/8	-10	15,9	1/2	105	66	26	32
16F77-12-10	16	5/8	-10	15,9	3/4	104	66	26	41
16F77-16-10	16	5/8	-10	15,9	1	105	66	26	48
16F77-12-12	19	3/4	-12	19,1	3/4	116,2	70	26	41
16F77-16-12	19	3/4	-12	19,1	1	116	70	26	48
16F77-12-16	25	1	-16	25,4	3/4	132	78	32	41
16F77-16-16	25	1	-16	25,4	1	141	87	32	48
16F77-20-16	25	1	-16	25,4	1 1/4	142	88	32	54
16F77-16-20	31	1 1/4	-20	31,8	1	159	95	38	48
16F77-20-20	31	1 1/4	-20	31,8	1 1/4	162	99	38	54
16F77-24-20	31	1 1/4	-20	31,8	1 1/2	162	99	38	64
16F77-20-24	38	1 1/2	-24	38,1	1 1/4	179	112	44	54
16F77-24-24	38	1 1/2	-24	38,1	1 1/2	187	120	44	64
16F77-32-24	38	1 1/2	-24	38,1	2	187	120	44	79
16F77-32-32	51	2	-32	50,8	2	211	134	56	79

Se pueden usar terminales con junta tórica estándar para temperaturas desde -40 °C hasta +105 °C.

Serie de terminales aprobados para **tipos de manguera**, dependiendo del tamaño:

77 387 387ST 387TC 487 487ST 487TC 787 787TC 787ST 797 797TC 797ST 797RH SX42

6N Brida ISO 6162-2 Codo 90°

ISO 12151-3 – E-S – SFS 90°
(42,0 MPa/ 6000 psi)

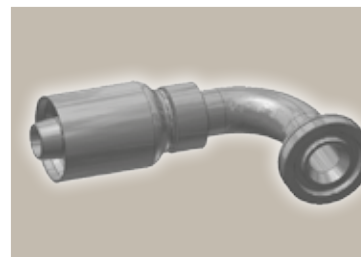
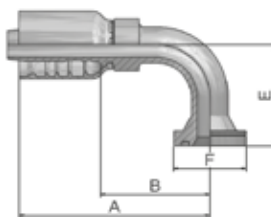

Referencia	D.I. de manguera				Terminal Pulg.	A mm	B mm	E mm	F mm
	DN	Pulg.	Tamaño	mm					
16N77-8-8	12	1/2	-8	12,7	1/2	77,05	42	41	32
16N77-12-8	12	1/2	-8	12,7	3/4	81,05	47	45	41
16N77-8-10	16	5/8	-10	15,9	1/2	92	53	54	32
16N77-12-10	16	5/8	-10	15,9	3/4	92	53	54	41
16N77-16-10	16	5/8	-10	15,9	1	92	53	54	48
16N77-12-12	19	3/4	-12	19,1	3/4	108,2	62	58	41
16N77-16-12	19	3/4	-12	19,1	1	108	62	58	48
16N77-20-12	19	3/4	-12	19,1	1 1/4	108	62	63	54
16N77-12-16	25	1	-16	25,4	3/4	118	64	70	41
16N77-16-16	25	1	-16	25,4	1	131	77	70	48
16N77-20-16	25	1	-16	25,4	1 1/4	135	81	70	54
16N77-16-20	31	1 1/4	-20	31,8	1	145	82	90	48
16N77-20-20	31	1 1/4	-20	31,8	1 1/4	151	87	90	54
16N77-24-20	31	1 1/4	-20	31,8	1 1/2	151	87	90	64
16N77-20-24	38	1 1/2	-24	38,1	1 1/4	156	89	104	54
16N77-24-24	38	1 1/2	-24	38,1	1 1/2	175	108	104	64
16N77-32-24	38	1 1/2	-24	38,1	2	175	108	104	79
16N77-32-32	51	2	-32	50,8	2	223	138	138	79

Se pueden usar terminales con junta tórica estándar para temperaturas desde -40 °C hasta +105 °C.

Serie de terminales aprobados para tipos de manguera, dependiendo del tamaño:

77 387 387ST 387TC 487 487ST 487TC 787 787TC 787ST 797 797TC 797ST 797RH SX42

X5 Brida

Sistema completo de brida ISO 6162-1 o ISO 6162-2

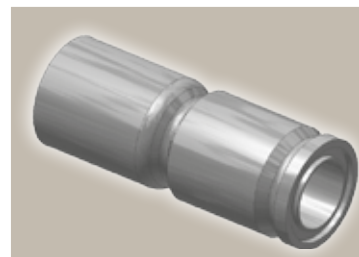
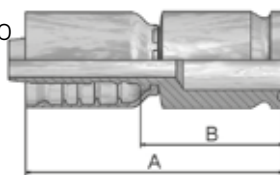

Referencia	D.I. de manguera				Terminal Pulg.	A mm	B mm
	DN	Pulg.	Tamaño	mm			
1X577-12-12	19	3/4	-12	19,1	3/4	103	57
1X577-16-12	19	3/4	-12	19,1	1	103	57
1X577-16-16	25	1	-16	25,4	1	113	59
1X577-20-16	25	1	-16	25,4	1 1/4	113	59
1X577-24-16	25	1	-16	25,4	1 1/2	113	59
1X577-20-20	31	1 1/4	-20	31,8	1 1/4	124	57
1X577-24-24	38	1 1/2	-24	38,1	1 1/2	129	62
1X577-32-32	51	2	-32	50,8	2	154	77

X7 Brida - Codo 45°

Sistema completo de brida ISO 6162-1 o ISO 6162-2

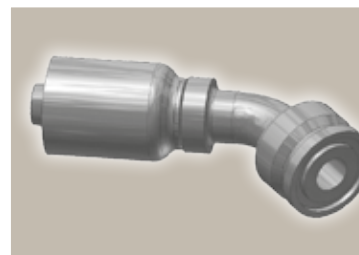
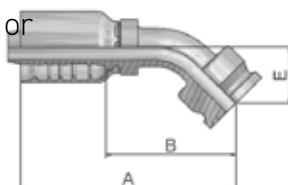

Referencia	D.I. de manguera				Terminal Pulg.	A mm	B mm	E mm
	DN	Pulg.	Tamaño	mm				
1X777-12-12	19	3/4	-12	19,1	3/4	119	73	29
1X777-16-12	19	3/4	-12	19,1	1	118	72	29
1X777-16-16	25	1	-16	25,4	1	141	87	32
1X777-20-16	25	1	-16	25,4	1 1/4	147	93	38
1X777-16-20	31	1 1/4	-20	31,8	1	146	82	38
1X777-20-20	31	1 1/4	-20	31,8	1 1/4	159	96	38
1X777-24-20	31	1 1/4	-20	31,8	1 1/2	165	102	44
1X777-24-24	38	1 1/2	-24	38,1	1 1/2	183	116	45



Serie de terminales aprobados para tipos de manguera, dependiendo del tamaño:

77 | 387 | 387ST | 387TC | 487 | 487ST | 487TC | 787 | 787TC | 787ST | 797 | 797TC | 797ST | 797RH | SX42

X9 Brida – Codo 90°

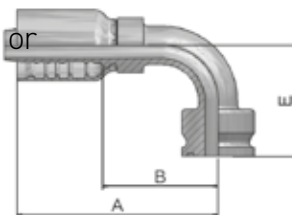

Sistema completo de brida ISO 6162-1 or
ISO 6162-2

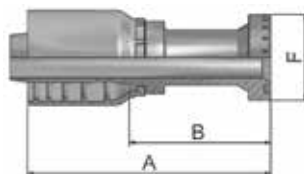

Referencia	 D.I. de manguera				 Terminal	A mm	B mm	E mm
	DN	Pulg.	Tamaño	mm	Pulg.			
1X977-8-8	12	1/2	-8	12,7	1/2	81	45	43
1X977-12-12	19	3/4	-12	19,1	3/4	108	62	61
1X977-16-12	19	3/4	-12	19,1	1	108	62	61
1X977-12-16	25	1	-16	25,4	3/4	110	56	70
1X977-16-16	25	1	-16	25,4	1	131	77	70
1X977-20-16	25	1	-16	25,4	1 1/4	131	77	70
1X977-16-20	31	1 1/4	-20	31,8	1	130	67	90
1X977-20-20	31	1 1/4	-20	31,8	1 1/4	148	84	90
1X977-24-20	31	1 1/4	-20	31,8	1 1/2	148	84	90
1X977-24-24	38	1 1/2	-24	38,1	1 1/2	170	103	104
1X977-32-32	51	2	-32	50,8	2	221	144	138

XA Brida Caterpillar® Recta



Referencia	 D.I. de manguera				 Terminal	A mm	B mm	F mm
	DN	Pulg.	Tamaño	mm	Pulg.			
1XA77-12-12	19	3/4	-12	19,1	3/4	114	68	41
1XA77-16-12	19	3/4	-12	19,1	3/4	88	42	48
1XA77-16-16	25	1	-16	25,4	1	141	87	48
1XA77-20-16	25	1	-16	25,4	1	104	50	54
1XA77-20-20	31	1 1/4	-20	31,8	1 1/4	152	88	54
1XA77-24-20	31	1 1/4	-20	31,8	1 1/2	121	57	64
1XA77-24-24	38	1 1/2	-24	38,1	1 1/2	176	109	64
1XA77-32-24	38	1 1/2	-24	38,1	2	133	66	79
1XA77-32-32	51	2	-32	50,8	2	192	115	79

Serie de terminales aprobados para tipos de manguera, dependiendo del tamaño:

77 387 387ST 387TC | 487 487ST 487TC | 787 787TC 787ST 797 797TC 797ST 797RH SX42

XF Brida Caterpillar®
Codo 45°

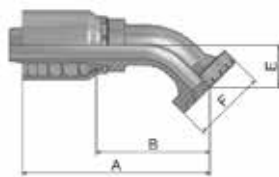

Referencia	D.I. de manguera				Terminal Pulg.	A mm	B mm	E mm	F mm
	DN	Pulg.	Tamaño	mm					
1XF77-12-12	19	3/4	-12	19,1	3/4	122	76	31	41
1XF77-16-16	25	1	-16	25,4	1	145	91	36	48
1XF77-20-20	31	1 1/4	-20	31,8	1 1/4	161	98	37	54
1XF77-24-20	31	1 1/4	-20	31,8	1 1/2	161	98	37	64

XG Brida Caterpillar®
Codo 60°

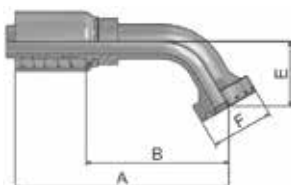

Referencia	D.I. de manguera				Terminal Pulg.	A mm	B mm	E mm	F mm
	DN	Pulg.	Tamaño	mm					
1XG77-12-12	19	3/4	-12	19,1	3/4	137	91	42	41
1XG77-16-16	25	1	-16	25,4	1	163	109	50	48
1XG77-20-20	31	1 1/4	-20	31,8	1 1/4	200	136	51	54

Serie de terminales aprobados para tipos de manguera, dependiendo del tamaño:

77 | 387 | 387ST | 387TC | 487 | 487ST | 487TC | 787 | 787TC | 787ST | 797 | 797TC | 797ST | 797RH | SX42

XN Brida Caterpillar®
Codo 90°

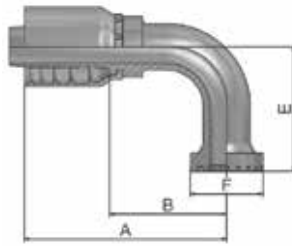

Referencia	D.I. de manguera				Terminal Pulg.	A mm	B mm	E mm	F mm
	DN	Pulg.	Tamaño	mm					
1XN77-12-12	19	3/4	-12	19,1	3/4	108	62	63	41
1XN77-16-12	19	3/4	-12	19,1	1	108	62	63	48
1XN77-16-16	25	1	-16	25,4	1	131	77	74	48
1XN77-20-16	25	1	-16	25,4	1 1/4	131	77	74	54
1XN77-20-20	31	1 1/4	-20	31,8	1 1/4	151	87	94	54
1XN77-24-20	31	1 1/4	-20	31,8	1 1/2	151	87	77	64
1XN77-24-24	38	1 1/2	-24	38,1	1 1/2	160	103	106	79
1XN77-32-24	38	1 1/2	-24	38,1	2	169	103	106	79

K5 Brida Komatsu®
Recta

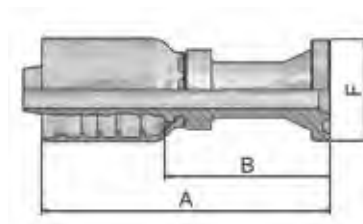

Referencia	D.I. de manguera				A mm	B mm
	DN	Pulg.	Tamaño	mm		
1K577-16-16	25	1	-16	25,4	119	65

Serie de terminales aprobados para tipos de manguera, dependiendo del tamaño:

77 387 387ST 387TC 487 487ST 487TC 787 787TC 787ST 797 797TC 797ST 797RH SX42

K7 Brida Komatsu®
Codo 45°

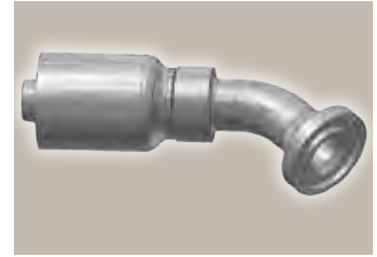
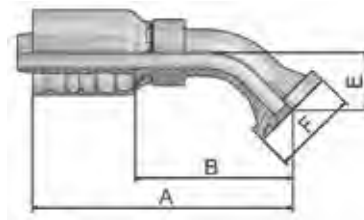

Referencia	D.I. de manguera				A mm	B mm	E mm
	DN	Pulg.	Tamaño	mm			
1K777-12-12	19	3/4	-12	19,1	116	70	26
1K777-16-16	25	1	-16	25,4	143	89	32
1K777-20-20	31	1 1/4	-20	31,8	159	96	38

K9 Brida Komatsu®
Codo 90°

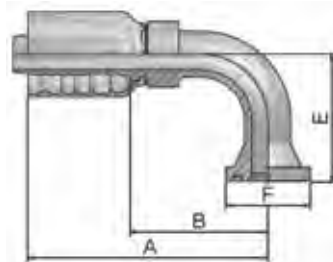

Referencia	D.I. de manguera				A mm	B mm	E mm
	DN	Pulg.	Tamaño	mm			
1K977-12-12	19	3/4	-12	19,1	108	62	58
1K977-16-16	25	1	-16	25,4	127	73	70
1K977-20-20	31	1 1/4	-20	31,8	148	84	90

Serie de terminales aprobados para tipos de manguera, dependiendo del tamaño:

77 387 | 387ST | 387TC | 487 | 487ST | 487TC | 787 | 787TC | 787ST | 797 | 797TC | 797ST | 797RH | SX42

JC Hembra giratoria ORFS Recta - Corta

ISO 12151-1 - SWSA
SAE J516 - ORFS

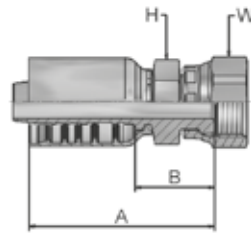

Referencia	D.I. de manguera				Rosca UNF	A mm	B mm	H mm	W mm
	DN	Pulg.	Tamaño	mm					
1JC77-8-8	12	1/2	-8	12,7	13/16x16	60	25	22	24
1JC77-10-8	12	1/2	-8	12,7	1x14	65	31	24	30
1JC77-12-8	12	1/2	-8	12,7	1 3/16x12	64	29	30	36
1JC77-10-10	16	5/8	-10	15,9	1x14	70	31	24	30
1JC77-12-10	16	5/8	-10	15,9	1 3/16x16	69	30	30	36
1JC77-10-12	19	3/4	-12	19,1	1x14	79	33	30	30
1JC77-12-12	19	3/4	-12	19,1	1 3/16x12	79	33	30	36
1JC77-16-12	19	3/4	-12	19,1	1 7/16x12	81	35,3	36	41
1JC77-12-16	25	1	-16	25,4	1 3/16x12	92	38	36	36
1JC77-16-16	25	1	-16	25,4	1 7/16x12	91	37,1	36	41
1JC77-20-16	25	1	-16	25,4	1 11/16x12	90	36	41	50
1JC77-20-20	31	1 1/4	-20	31,8	1 11/16x12	107	44	46	50
1JC77-24-24	38	1 1/2	-24	38,1	2x12	109	43	50	60
1JC77-32-32	51	2	-32	50,8	2 1/2x12	143	66	65	75

J7 Hembra giratoria ORFS Codo 45°

ISO 12151-1 - SWE 45°
SAE J516 - ORFS 45°

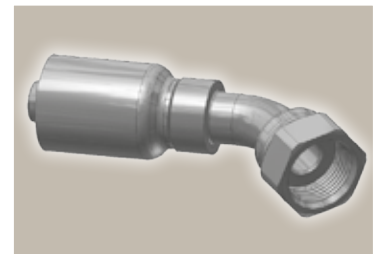
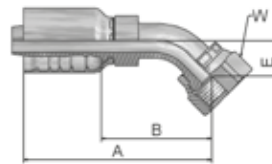

Referencia	D.I. de manguera				Rosca UNF	A mm	B mm	E mm	W mm
	DN	Pulg.	Tamaño	mm					
1J777-8-8	12	1/2	-8	12,7	13/16x16	72,7	38	15	24
1J777-10-10	16	5/8	-10	15,9	1x14	93	54	16	30
1J777-12-10	16	5/8	-10	15,9	1 3/16x12	98	59	21	36
1J777-12-12	19	3/4	-12	19,1	1 3/16x12	111	65	21	36
1J777-16-12	19	3/4	-12	19,1	1 7/16x12	114	68	24	41
1J777-16-16	25	1	-16	25,4	1 7/16x12	133	79	24	41
1J777-20-20	31	1 1/4	-20	31,8	1 11/16x12	145	81	25	50
1J777-24-20	31	1 1/4	-20	31,8	2x12	148	84	27	60
1J777-24-24	38	1 1/2	-24	38,1	2x12	176	109	42	60

Serie de terminales aprobados para tipos de manguera, dependiendo del tamaño:

77 387 387ST 387TC 487 487ST 487TC 787 787TC 787ST 797 797TC 797ST 797RH SX42

J9 Hembra giratoria ORFS Codo 90° – Corto

ISO 12151-1 – SWES
SAE J516 – ORFS 90°

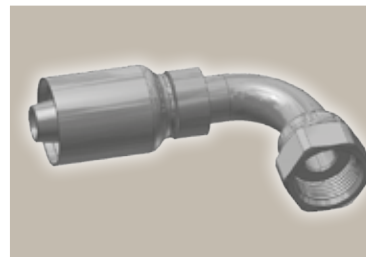
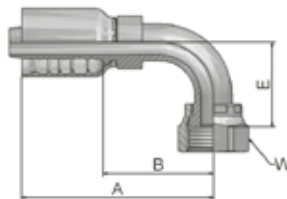

Referencia	D.I. de manguera				Rosca UNF	A mm	B mm	E mm	W mm
	DN	Pulg.	Tamaño	mm					
1J977-8-8	12	1/2	-8	12,7	13/16x16	70,65	36	29	24
1J977-10-10	16	5/8	-10	15,9	1x14	97	50	32	30
1J977-12-10	16	5/8	-10	15,9	1 3/16x12	89	50	48	36
1J977-10-12	19	3/4	-12	19,1	1x14	97	51	32	30
1J977-12-12	19	3/4	-12	19,1	1 3/16x12	108	62	48	36
1J977-16-12	19	3/4	-12	19,1	1 7/16x12	108	62	56	41
1J977-16-16	25	1	-16	25,4	1 7/16x12	131	77	56	41
1J977-20-20	31	1 1/4	-20	31,8	1 11/16x12	146	82	64	50
1J977-24-24	38	1 1/2	-24	38,1	2x12	163	96	69	60

J1 Hembra giratoria ORFS Codo 90° – Largo

ISO 12151-1 – SWEL
SAE J 516 – ORFS 90° L

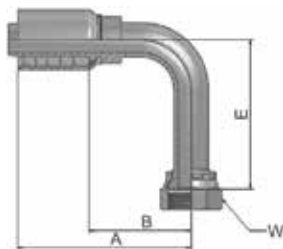

Referencia	D.I. de manguera				Rosca UNF	A mm	B mm	E mm	W mm
	DN	Pulg.	Tamaño	mm					
1J177-12-12	19	3/4	-12	19,1	1 3/16x12	108	62	96	36
1J177-16-16	25	1	-16	25,4	1 7/16x12	131	77	114	41

Serie de terminales aprobados para tipos de manguera, dependiendo del tamaño:

77 387 387ST 387TC 487 487ST 487TC 787 787TC 787ST 797 797TC 797ST 797RH SX42

JM Macho ORFS
ISO 12151-1-S – SAE J516

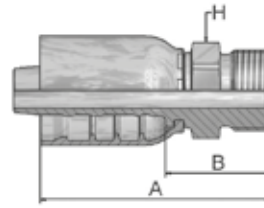

Referencia	D.I. de manguera				Rosca UNF	A mm	B mm	H mm
	DN	Pulg.	Tamaño	mm				
1JM77-8-8	12	1/2	-8	12,7	13/16x16	62,5	27,85	22
1JM77-12-8	12	1/2	-8	12,7	1 3/16x12	69,6	34,95	32
1JM77-10-10	16	5/8	-10	15,9	1x14	71,65	33	27
1JM77-12-10	16	5/8	-10	15,9	1 3/16x12	76	37	30
1JM77-12-12	19	3/4	-12	19,1	1 3/16x12	83	37	32
1JM77-16-12	19	3/4	-12	19,1	1 7/16x12	83,6	37,8	41
1JM77-16-16	25	1	-16	25,4	1 7/16x12	96	40,9	41
1JM77-20-16	25	1	-16	25,4	1 11/16x12	93	39,2	46
1JM77-20-20	31	1 1/4	-20	31,8	1 11/16x12	110	46	46
1JM77-24-20	31	1 1/4	-20	31,8	2 12	116	52	55



Los terminales JM se suministran sin junta tórica.

Serie de terminales aprobados para **tipos de manguera**, dependiendo del tamaño:

77 387 387ST 387TC 487 487ST 487TC 787 787TC 787ST 797 797TC 797ST 797RH SX42

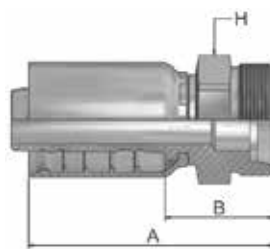
**FG Macho Gaz francés
Rígido
Recto (Cono 24°)**



Referencia	 D.I. de manguera				 Rosca métrica	A mm	B mm	 H mm
	DN	Pulg.	Tamaño	mm				
1FG77-27-12	19	3/4	-12	19,1	M36x1,5	82	36	36
1FG77-33-16	25	1	-16	25,4	M45x1,5	97	43	46

Serie de terminales aprobados para **tipos de manguera**, dependiendo del tamaño:

77 387 387ST 387TC 487 487ST 487TC 787 787TC 787ST 797 797TC 797ST 797RH SX42

Amplia gama de racores de manguera especiales para el mercado MRO

La demanda de racores de manguera especiales forma parte de nuestro trabajo diario. Para satisfacer esta demanda con la autoridad que se espera, la Hose Products Division en Europa ha ampliado su oferta habitual con racores de manguera especiales, por ejemplo de longitud de bajada extra, etc.

A continuación tiene información general sobre nuestra selección de racores de especiales de mangueras:

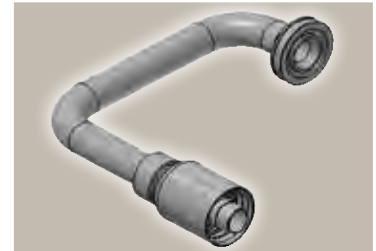
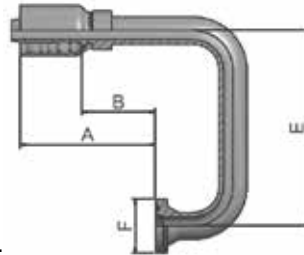

Otros racores especiales están disponibles bajo pedido.

Referencia	Descripción			A mm	B mm	E mm	F mm
		#_HoseID # Módulo	#_flange # Pulg.				
11977-12-12-SL100	Codo SAE 5000 psi 90° con longitud de bajada de 100 mm	-12	3/4	108	62	100	38
11977-12-12-SL150	Codo SAE 5000 psi 90° con longitud de bajada de 150 mm	-12	3/4	108	62	150	38
11977-16-12-SL100	Codo SAE 5000 psi 90° con longitud de bajada de 100 mm	-12	1	108	62	100	45
11977-16-12-SL150	Codo SAE 5000 psi 90° con longitud de bajada de 150 mm	-12	1	108	62	150	45
11977-16-16-SL150	Codo SAE 5000 psi 90° con longitud de bajada de 150 mm	-16	1	131	77	150	45
14N77-24-24-SL150	Codo SAE 5000 psi 90° con longitud de bajada de 150 mm	-24	1 1/2	175	108	150	60
16A77-20-20-RL186	Recto SAE 6000 psi (especial)	-20	1 1/4	175	112		54
16F77-12-16-STB10	Codo en 10° SAE 6000 psi	-16	3/4	143	89	6	41
16F77-20-16-RL110	Codo en 45° SAE 6000 psi (especial)	-16	1 1/4	164	110	32	54
16N77-12-12-SL100	Codo SAE 6000 psi 90° con longitud de bajada de 100 mm	-12	3/4	108	62	100	41
16N77-12-12-SL230	Codo SAE 6000 psi 90° con longitud de bajada de 230 mm	-12	3/4	108	62	230	41
16N77-12-12-SL72	Codo SAE 6000 psi 90° con longitud de bajada de 72 mm	-12	3/4	108	62	72	41
16N77-12-12-SL85	Codo SAE 6000 psi 90° con longitud de bajada de 85 mm	-12	3/4	108	62	85	41
16N77-12-12-STB115	Codo en 115° SAE 6000 psi	-12	3/4	116	70	72	41
16N77-12-12-STB180	Codo en 180° SAE 6000 psi	-12	3/4	101	55	150	41
16N77-12-16-SL55	Codo SAE 6000 psi 90° con longitud de bajada de 85 mm	-16	3/4	118	64	55	41
16N77-12-16-SL95	Codo SAE 6000 psi 90° con longitud de bajada de 95 mm	-16	3/4	118	64	95	41
16N77-16-16-SL100	Codo SAE 6000 psi 90° con longitud de bajada de 100 mm	-16	1	131	77	100	48
16N77-16-16-SL110	Codo SAE 6000 psi 90° con longitud de bajada de 110 mm	-16	1	131	77	110	48
16N77-16-16-SL120	Codo SAE 6000 psi 90° con longitud de bajada de 120 mm	-16	1	131	77	120	48
16N77-16-16-SL150	Codo SAE 6000 psi 90° con longitud de bajada de 150 mm	-16	1	131	77	150	48
16N77-16-16-SL175	Codo SAE 6000 psi 90° con longitud de bajada de 175 mm	-16	1	135	81	175	48
16N77-16-16-STB120	Codo en 120° SAE 6000 psi	-16	1	110	56	85	48
16N77-16-16-STB63-SL75	Codo SAE 6000 psi 63° con longitud de bajada de 75 mm	-16	1	167	113	75	48
16N77-20-16-SL120	Codo SAE 6000 psi 90° con longitud de bajada de 120 mm	-16	1 1/4	135	81	120	54
16N77-20-16-SL130	Codo SAE 6000 psi 90° con longitud de bajada de 130 mm	-16	1 1/4	135	81	130	54
16N77-20-16-STB110-SL150	Codo SAE 6000 psi 110° con longitud de bajada de 150 mm	-16	1 1/4	128	74	150	54
16N77-20-16-STB70-SL70	Codo SAE 6000 psi 70° con longitud de bajada de 70 mm	-16	1 1/4	157	103	70	54
16N77-20-20-SL115-RL220	Codo SAE 6000 psi 90° con longitud de bajada de 220 mm	-20	1 1/4	220	156	115	54
16N77-20-20-SL120	Codo SAE 6000 psi 90° con longitud de bajada de 120 mm	-20	1 1/4	151	87	120	54
16N77-20-20-SL150-RL150	Codo SAE 6000 psi 90° con longitud de bajada de 150 mm	-20	1 1/4	238	175	150	54
16N77-20-20-SL150-RL220	Codo SAE 6000 psi 90° con longitud de bajada de 150 mm	-20	1 1/4	220	156	150	54
16N77-20-20-SL195-RL320	Codo SAE 6000 psi 90° con longitud de bajada de 195 mm	-20	1 1/4	320	256	195	54
16N77-20-20-SL230-RL250	Codo SAE 6000 psi 90° con longitud de bajada de 230 mm	-20	1 1/4	338	275	230	54
16N77-20-20-SL230-RL320	Codo SAE 6000 psi 90° con longitud de bajada de 230 mm	-20	1 1/4	320	256	230	54
16377-16-16	Codo en 135° SAE 6000 psi	-16	1	122	68	88	48
16377-20-20	Codo en 135° SAE 6000 psi	-20	1 1/4	132	69	109	54
16377-24-24	Codo en 135° SAE 6000 psi	-24	1 1/2	124	57	129	64

Serie de terminales aprobados para tipos de manguera, dependiendo del tamaño:

77	387	387ST	387TC	487	487ST	487TC	787	787TC	787ST	797	797TC	797ST	797RH	SX42
-----------	-----	-------	-------	-----	-------	-------	-----	-------	-------	-----	-------	-------	-------	------

RACORES SERIE V4/V6



Casquillo

Página Df-1

V4

Df-1



Interlock
Pelado interno / externo
Mangueras de 4 mallas

V6

Df-1



Interlock
Pelado interno / externo
Mangueras de 6 mallas

DIN – Métrica

Página Df-2 – Df-5

CA

Df-2



Hembra giratoria métrica 24°
Serie ligera con junta tórica
Recta
ISO 12151-2-SWS-L – DKOL

CE

Df-2



Hembra giratoria métrica 24°
Serie ligera con junta tórica
Codo 45°
ISO 12151-2-SWE 45°-L – DKOL 45°

CF

Df-3



Hembra giratoria métrica 24°
Serie ligera con junta tórica
Codo 90°
ISO 12151-2-SWE-L – DKOL 90°

C9

Df-3



Hembra giratoria métrica 24°
Serie pesada con junta tórica
Recta
ISO 12151-2-SWS-S – DKOS

OC

Df-4



Hembra giratoria métrica 24°
Serie pesada con junta tórica
Codo 45°
ISO 12151-2 – SWE 45°-S – DKOS 45°

1C

Df-4



Hembra giratoria métrica 24°
Serie pesada con junta tórica
Codo 90°
ISO 12151-2-SWE-S – DKOS 90°

D2

Df-5



Macho métrico recto 24°
Serie pesada
Rígido
ISO 12151-2-S-S – CES

BSP

Página Df-6 – Df-8

92

Df-6



Hembra giratoria BSP
(Asiento 60°)
BS5200-A – DKR

B1

Df-6



Hembra giratoria BSP cónica
Codo 45° (Cono 60°)
BS 5200-D – DKR 45°

B2

Df-7



Hembra giratoria BSP
Cilíndrica
Codo 90° (Asiento 60°)
BS 5200-B – DKR 90°

D9

Df-7



Macho cilíndrico BSP
Rígido – Recto (Cono 60°)
BS5200 – AGR

91

Df-8



Macho cónico BSP
Rígido – Recto
BS5200 – AGR-K

SAE

Página Df-9 – Df-11

01

Df-9



Macho NPTF fijo
Rígido – Recto
SAE J476A / J516 – AGN

03

Df-9



Macho JIC 37°
Rígido – Recto
ISO12151-5-S – AGJ

06

Df-10

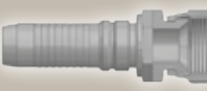

Hembra giratoria JIC 37°
Recta
ISO12151-5-SWS – DKJ

37

Df-10

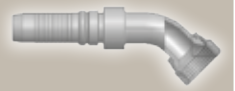

Hembra giratoria JIC 37°
Codo 45°
ISO 12151-5-SWE 45° – DKJ 45°

39



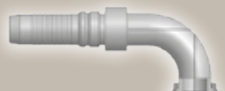







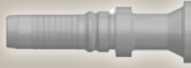

Df-11

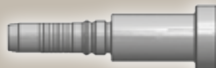

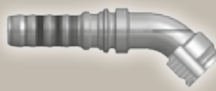
Hembra giratoria JIC 37°
Codo 90°
ISO 12151-5-SWES – DKJ 90°

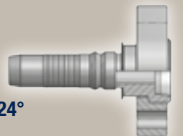
Bridas

Página Df-12 – Df-22

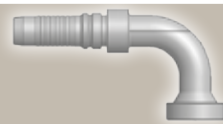
<p>15/4A Df-12</p>  <p>Brida ISO 6162-1 Recta ISO 12151-3-S-L – SFL (35,0 MPa/ 5000 psi)</p>	<p>17/4F Df-13</p>  <p>Brida ISO 6162-1 Codo 45° ISO 12151-3 – E45S – L – SFL 45° (35,0 MPa/ 5000 psi)</p>	<p>19/4N Df-14</p>  <p>Brida ISO 6162-1 Codo 90° ISO 12151-3-E-L – SFL 90° (35,0 MPa/ 5000 psi)</p>	<p>6A Df-15</p>  <p>Brida ISO 6162-2 Recta ISO 12151-3-S-S – SFS (42,0 MPa/ 6000 psi)</p>
<p>6F Df-16</p>  <p>Brida ISO 6162-2 Codo 45° ISO 12151-3 – E45S – SFS 45° (42,0 MPa/ 6000 psi)</p>	<p>6N Df-17</p>  <p>Brida ISO 6162-2 Codo 90° ISO 12151-3 – E-S – SFS 90° (42,0 MPa/ 6000 psi)</p>	<p>8A Df-18</p>  <p>Brida – Recta 8000 psi</p>	<p>8F Df-18</p>  <p>Brida – Codo 45° 8000 psi</p>
<p>8N Df-19</p>  <p>Brida – Codo 90° 8000 psi</p>	<p>X5 Df-19</p>  <p>Brida Sistema completo de brida ISO 6162-1 o ISO 6162-2</p>	<p>X7 Df-20</p>  <p>Brida – Codo 45° Sistema completo de brida ISO 6162-1 or ISO 6162-2</p>	<p>X9 Df-20</p>  <p>Brida – Codo 90° Sistema completo de brida ISO 6162-1 or ISO 6162-2</p>
<p>PY Df-21</p>  <p>Brida – Macho 24° Gas Francés Recta</p>	<p>XA Df-21</p>  <p>Brida Caterpillar® Recta</p>	<p>XF Df-22</p>  <p>Brida Caterpillar® Codo 45°</p>	<p>XG Df-22</p>  <p>Brida Caterpillar® Codo 60°</p>
<p>XN Df-23</p>  <p>Brida Caterpillar® Codo 90°</p>			

ORFS

Página Df-23 – Df-25

<p>JC Df-24</p>  <p>Hembra giratoria ORFS Recta – Corta ISO 12151-1 – SWSA SAE J516 – ORFS</p>	<p>JS Df-24</p>  <p>Hembra giratoria ORFS (Larga) ISO 12151-1-SWSB SAE J516 – ORFS</p>	<p>J7 Df-25</p>  <p>Hembra giratoria ORFS Codo 45° ISO 12151-1 – SWE 45° SAE J516 – ORFS 45°</p>	<p>J9 Df-25</p>  <p>Hembra giratoria ORFS Codo 90° – Corto ISO 12151-1 – SWES SAE J516 – ORFS 90°</p>
<p>JM Df-26</p>  <p>Macho ORFS ISO 12151-1-S – SAE J516</p>			

Estándar Francés

Página Df-26

<p>FG Df-27</p>  <p>Macho Gaz francés Rígido Recto (Cono 24°)</p>	<p>F4 Df-27</p>  <p>Hembra giratoria francesa Serie Gaz Recta (Asiento ovalado)</p>
--	--

V4 Interlock Pelado interno / externo

Mangueras de 4 mallas

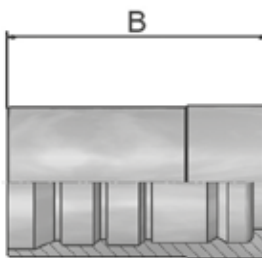

Solo para uso con prensas ajustables. Requiere un mínimo de 320 toneladas de fuerza de prensado.

Referencia	D.I. de manguera				B mm
	DN	Pulg.	Tamaño	mm	
100V4-10	16	5/8	-10	15,9	49
100V4-12	19	3/4	-12	19,1	60
100V4-16	25	1	-16	25,4	75
100V4-20 *	31	1 1/4	-20	31,8	88
100V6-20 *	31	1 1/4	-20	31,8	90
100V4-24 *	38	1 1/2	-24	38,1	94

* no apto para R42, R42TC y R42ST

V6 Interlock Pelado interno / externo

Mangueras de 6 mallas



Solo para uso con prensas ajustables. Requiere un mínimo de 340 toneladas de fuerza de prensado.

Referencia	D.I. de manguera				B mm
	DN	Pulg.	Tamaño	mm	
100V6-24	38	1 1/2	-24	38,1	96
100V6-32	51	2	-32	50,8	110
100V6-40	63	2 1/2	-40	63,5	134
100V6-48	76	3	-48	76,2	110

Serie de terminales aprobados para tipos de manguera, dependiendo del tamaño:

V4 H31 H31TC H31ST R42 42TC R42ST R35 R35TC RD35TC RS35TC R50TC R56TC H29 H29TC H29ST FA35

V6 R35 R35TC RD35TC RS35TC R42 R42ST R42TC R50TC R56TC FA35

CA Hembra giratoria métrica 24° Serie ligera con junta tórica Recta

ISO 12151-2-SWS-L – DKOL

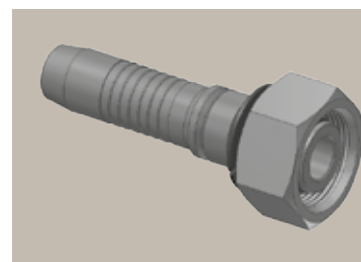
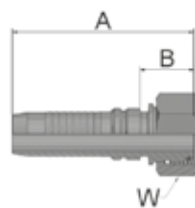

Referencia	D.I. de manguera				Rosca métrica	Tubo D.E. mm	A mm	B mm	W mm
	DN	Pulg.	Tamaño	mm					
KCAV4-22-12	19	3/4	-12	19,1	M30x2	22	89	28	36
KCAV4-28-16	25	1	-16	25,4	M36x2	28	103	31	41
KCAV4-35-20	31	1 1/4	-20	31,8	M45x2	35	120	32	50
KCAV6-35-20	31	1 1/4	-20	31,8	M45x2	35	130	39	50
KCAV4-42-24	38	1 1/2	-24	38,1	M52x2	42	128	35	60
KCAV6-42-24	38	1 1/2	-24	38,1	M52x2	42	138	42	60

Se pueden usar terminales con junta tórica estándar para temperaturas desde -40 °C hasta +105 °C.

CE Hembra giratoria métrica 24° Serie ligera con junta tórica Codo 45°

ISO 12151-2-SWE 45°-L – DKOL 45°

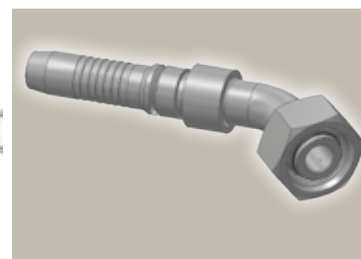
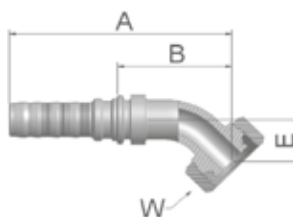

Referencia	D.I. de manguera				Rosca métrica	Tubo D.E. mm	A mm	B mm	E mm	W mm
	DN	Pulg.	Tamaño	mm						
KCEV4-22-12	19	3/4	-12	19,1	M30x2	22	137	75	29	36
KCEV4-35-20	31	1 1/4	-20	31,8	M45x2	35	197	109	37	50
KCEV6-35-20	31	1 1/4	-20	31,8	M45x2	35	188	97	37	50
KCEV6-42-24	38	1 1/2	-24	38,1	M52x2	42	226	130	49	60

Se pueden usar terminales con junta tórica estándar para temperaturas desde -40 °C hasta +105 °C.

Serie de terminales aprobados para tipos de manguera, dependiendo del tamaño:

V4	H31 H31TC H31ST R42 42TC R42ST R35 R35TC RD35TC RS35TC R50TC R56TC H29 H29TC H29ST FA35
V6	R35 R35TC RD35TC RS35TC R42 R42ST R42TC R50TC R56TC FA35

CF Hembra giratoria métrica 24° Serie ligera con junta tórica Codo 90°

ISO 12151-2-SWE-L – DKOL 90°

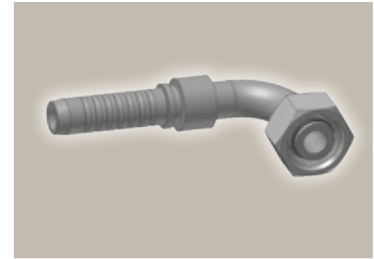
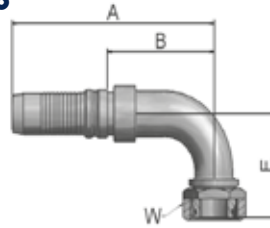

Referencia	D.I. de manguera				Rosca métrica	Tubo D.E. mm	A mm	B mm	E mm	W mm
	DN	Pulg.	Tamaño	mm						
KCFV4-22-16	25	1	-16	25,4	M30x2	22	150	77	70	36
KCFV4-35-20	31	1 1/4	-20	31,8	M45x2	35	186	98	79	50
KCFV6-35-20	31	1 1/4	-20	31,8	M45x2	35	177	86	79	50
KCFV6-42-24	38	1 1/2	-24	38,1	M52x2	42	209	113	101	60

Se pueden usar terminales con junta tórica estándar para temperaturas desde -40 °C hasta +105 °C.
Vea sección Eb para dimensiones y referencias de juntas. Disponibles a petición terminales con juntas tóricas especiales.

C9 Hembra giratoria métrica 24° Serie pesada con junta tórica Recta

ISO 12151-2-SWS-S – DKOS

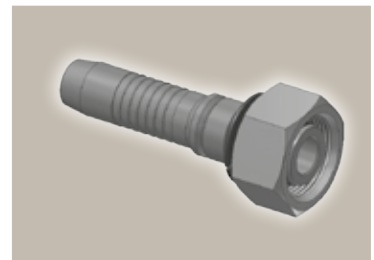
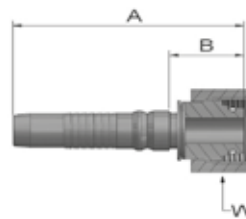

Referencia	D.I. de manguera				Rosca métrica	Tubo D.E. mm	A mm	B mm	W mm
	DN	Pulg.	Tamaño	mm					
KC9V4-20-10	16	5/8	-10	15,9	M30x2	20	87	27	36
KC9V4-20-12	19	3/4	-12	19,1	M30x2	20	88	26	36
KC9V4-25-12	19	3/4	-12	19,1	M36x2	25	91	30,3	46
KC9V4-30-12	19	3/4	-12	19,1	M42x2	30	95	33	50
KC9V4-25-16	25	1	-16	25,4	M36x2	25	103	30	46
KC9V4-30-16	25	1	-16	25,4	M42x2	30	108	35	50
KC9V4-38-16	25	1	-16	25,4	M52x2	38	110	37	60
KC9V4-30-20	31	1 1/4	-20	31,8	M42x2	30	123	35	50
KC9V4-38-20	31	1 1/4	-20	31,8	M52x2	38	126	38	60
KC9V6-30-20	31	1 1/4	-20	31,8	M42x2	30	131,5	41,5	50
KC9V6-38-20	31	1 1/4	-20	31,8	M52x2	38	135	44	60
KC9V4-38-24	38	1 1/2	-24	38,1	M52x2	38	129	36	60
KC9V6-38-24	38	1 1/2	-24	38,1	M52x2	38	139	43	60
KC9V6-54-32	51	2	-32	50,8	M68x2	54	175	65	80

Se pueden usar terminales con junta tórica estándar para temperaturas desde -40 °C hasta +105 °C.
Vea sección Eb para dimensiones y referencias de juntas. Disponibles a petición terminales con juntas tóricas especiales.

Serie de terminales aprobados para tipos de manguera, dependiendo del tamaño:

V4	H31 H31TC H31ST R42 42TC R42ST R35 R35TC RD35TC RS35TC R50TC R56TC H29 H29TC H29ST FA35
V6	R35 R35TC RD35TC RS35TC R42 R42ST R42TC R50TC R56TC FA35

0C Hembra giratoria métrica 24° Series pesada con junta tórica Codo 45°

ISO 12151-2 – SWE 45°-S – DKOS 45°

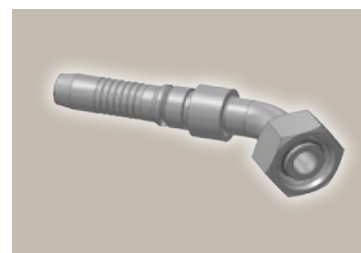
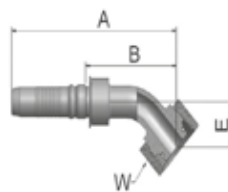

Referencia	D.I. de manguera				Rosca métrica	Tubo D.E. mm	A mm	B mm	E mm	W mm
	DN	Pulg.	Tamaño	mm						
K0CV4-20-10	16	5/8	-10	15,9	M30x2	20	124	65	26	36
K0CV4-20-12	19	3/4	-12	19,1	M30x2	20	138	76	30	36
K0CV4-25-12	19	3/4	-12	19,1	M36x2	25	137	76	29	46
K0CV4-25-16	25	1	-16	25,4	M36x2	25	161	88	33	46
K0CV4-30-16	25	1	-16	25,4	M42x2	30	162	88,7	33	50
K0CV4-30-20	31	1 1/4	-20	31,8	M42x2	30	193	105	34	50
K0CV4-38-20	31	1 1/4	-20	31,8	M52x2	38	197	108,7	37	60
K0CV6-30-20	31	1 1/4	-20	31,8	M42x2	30	184	93	34	50
K0CV6-38-20	31	1 1/4	-20	31,8	M52x2	38	187	96,3	37	60
K0CV4-38-24	38	1 1/2	-24	38,1	M52x2	38	227	133	49	60
K0CV6-38-24	38	1 1/2	-24	38,1	M52x2	38	226	130	49	60

Se pueden usar terminales con junta tórica estándar para temperaturas desde -40 °C hasta +105 °C.
Vea sección Eb para dimensiones y referencias de juntas. Disponibles a petición terminales con juntas tóricas especiales.

1C Hembra giratoria métrica 24° Serie pesada con junta tórica Codo 90°

ISO 12151-2-SWE-S – DKOS 90°

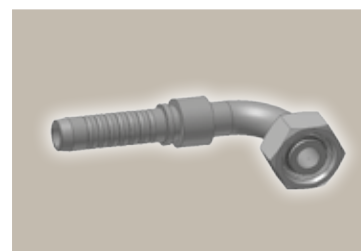
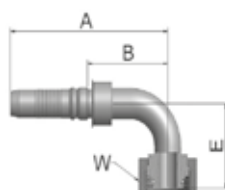

Referencia	D.I. de manguera				Rosca métrica	Tubo D.E. mm	A mm	B mm	E mm	W mm
	DN	Pulg.	Tamaño	mm						
K1CV4-20-10	16	5/8	-10	15,9	M30x2	20	112	52,3	50	36
K1CV4-20-12	19	3/4	-12	19,1	M30x2	20	125	63	60	36
K1CV4-25-12	19	3/4	-12	19,1	M36x2	25	126	65	59	46
K1CV4-25-16	25	1	-16	25,4	M36x2	25	150	77	69	46
K1CV4-30-16	25	1	-16	25,4	M42x2	30	151	77,7	69	50
K1CV4-38-16	25	1	-16	25,4	M52x2	38	150	77	68	60
K1CV4-30-20	31	1 1/4	-20	31,8	M42x2	30	183	95	73	50
K1CV4-38-20	31	1 1/4	-20	31,8	M52x2	38	187	98,7	78	60
K1CV6-30-20	31	1 1/4	-20	31,8	M42x2	30	169	78	69	50
K1CV6-38-20	31	1 1/4	-20	31,8	M52x2	38	177	86,3	78	60
K1CV4-38-24	38	1 1/2	-24	38,1	M52x2	38	210	117	101	60
K1CV6-38-24	38	1 1/2	-24	38,1	M52x2	38	209	113	101	60

Se pueden usar terminales con junta tórica estándar para temperaturas desde -40 °C hasta +105 °C.
Vea sección Eb para dimensiones y referencias de juntas. Disponibles a petición terminales con juntas tóricas especiales.

Serie de terminales aprobados para tipos de manguera, dependiendo del tamaño:



V4 H31 H31TC H31ST R42 42TC R42ST R35 R35TC RD35TC RS35TC R50TC R56TC H29 H29TC H29ST FA35

V6 R35 R35TC RD35TC RS35TC R42 R42ST R42TC R50TC R56TC FA35

D2 Macho métrico recto 24° Serie pesada Rígido

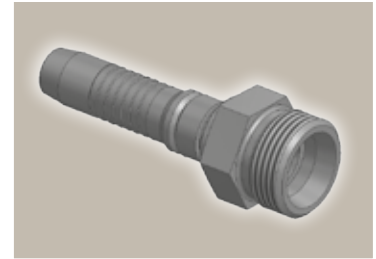
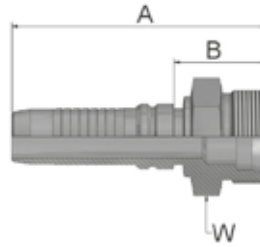
ISO 12151-2-S-S – CES



Referencia	 D.I. de manguera				 Rosca métrica	Tubo D.E. mm	A mm	B mm	 H mm
	DN	Pulg.	Tamaño	mm					
KD2V4-20-12	19	3/4	-12	19,1	M30x2	20	96	34	30
KD2V4-25-12	19	3/4	-12	19,1	M36x2	25	98	36,3	36
KD2V4-25-16	25	1	-16	25,4	M36x2	25	110,3	37,7	46
KD2V4-30-16	25	1	-16	25,4	M42x2	30	115	41,7	46
KD2V4-38-20	31	1 1/4	-20	31,8	M52x2	38	135	46,7	55
KD2V6-30-20	31	1 1/4	-20	31,8	M42x2	30	140	59	46
KD2V6-38-20	31	1 1/4	-20	31,8	M52x2	38	142	51	55
KD2V4-38-24	38	1 1/2	-24	38,1	M52x2	38	139	46	55
KD2V6-38-24	38	1 1/2	-24	38,1	M52x2	38	151	55	55

Serie de terminales aprobados para tipos de manguera, dependiendo del tamaño:

V4 H31 H31TC H31ST R42 42TC R42ST R35 R35TC RD35TC RS35TC R50TC R56TC H29 H29TC H29ST FA35

V6 R35 R35TC RD35TC RS35TC R42 R42ST R42TC R50TC R56TC FA35

92 Hembra giratoria BSP (Asiento 60°)

BS5200-A – DKR

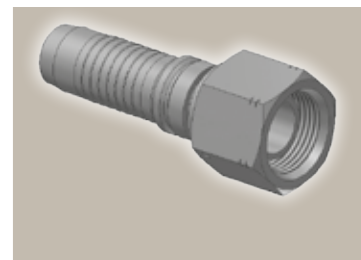
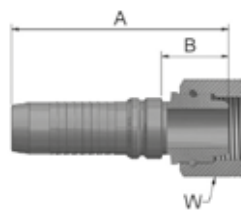

Referencia	D.I. de manguera				Rosca BSP	A mm	B mm	W mm
	DN	Pulg.	Tamaño	mm				
K92V4-10-10	16	5/8	-10	15,9	5/8x14	80	20,3	30
K92V4-12-12	19	3/4	-12	19,1	3/4x14	85	23,3	32
K92V4-16-12	19	3/4	-12	19,1	1x11	93	31,3	41
K92V4-16-16	25	1	-16	25,4	1x11	105	32	41
K92V4-20-20	31	1 1/4	-20	31,8	1 1/4x11	118	30	50
K92V6-20-20	31	1 1/4	-20	31,8	1 1/4x11	127	36	50
K92V4-24-24	38	1 1/2	-24	38,1	1 1/2x11	124	30,9	55
K92V6-24-24	38	1 1/2	-24	38,1	1 1/2x11	134	38	55
K92V4-32-32	51	2	-32	50,8	2x11	131	34,2	70
K92V6-32-32	51	2	-32	50,8	2x11	151	41	70

B1 Hembra giratoria BSP cónica Codo 45° (Cono 60°)

BS 5200-D – DKR 45°

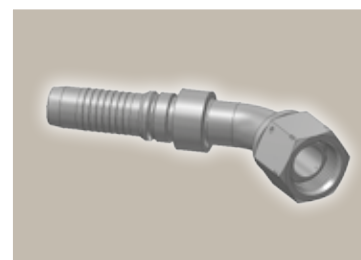
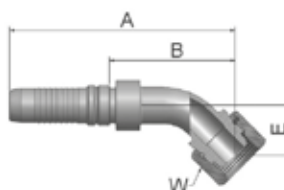

Referencia	D.I. de manguera				Rosca BSP	A mm	B mm	E mm	W mm
	DN	Pulg.	Tamaño	mm					
KB1V4-12-12	19	3/4	-12	19,1	3/4x14	134	72,3	26	32
KB1V4-16-16	25	1	-16	25,4	1x11	164	91	36	41
KB1V4-20-20	31	1 1/4	-20	31,8	1 1/4x11	198	109,7	38	50
KB1V6-20-20	31	1 1/4	-20	31,8	1 1/4x11	194	103	43	50
KB1V4-24-24	38	1 1/2	-24	38,1	1 1/2x11	230	137	52	55
KB1V6-24-24	38	1 1/2	-24	38,1	1 1/2x11	229	133	52	55
KB1V4-32-32	51	2	-32	50,8	2x11	277	180	70	70
KB1V6-32-32	51	2	-32	50,8	2x11	288	178	70	70

Serie de terminales aprobados para tipos de manguera, dependiendo del tamaño:

V4 H31 H31TC H31ST R42 42TC R42ST R35 R35TC RD35TC RS35TC R50TC R56TC H29 H29TC H29ST FA35

V6 R35 R35TC RD35TC RS35TC R42 R42ST R42TC R50TC R56TC FA35

B2 Hembra giratoria BSP
Cilíndrica
Codo 90° (Asiento 60°)
BS 5200-B – DKR 90°

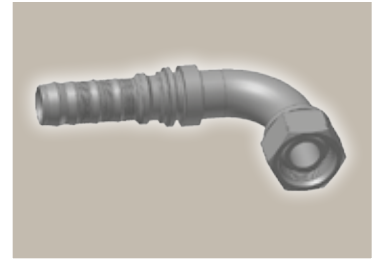
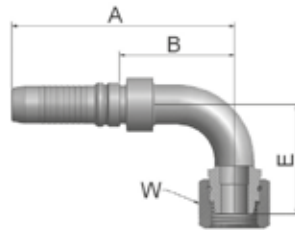

Referencia	D.I. de manguera				Rosca BSP	A mm	B mm	E mm	W mm
	DN	Pulg.	Tamaño	mm					
KB2V4-12-12	19	3/4	-12	19,1	3/4x14	125	63,3	55	32
KB2V4-16-16	25	1	-16	25,4	1x11	150	77	74	41
KB2V4-20-20	31	1 1/4	-20	31,8	1 1/4x11	186	98,7	80	50
KB2V6-20-20	31	1 1/4	-20	31,8	1 1/4x11	177	86	80	50
KB2V4-24-24	38	1 1/2	-24	38,1	1 1/2x11	210	116,9	103	55
KB2V6-24-24	38	1 1/2	-24	38,1	1 1/2x11	209	113	103	55
KB2V4-32-32	51	2	-32	50,8	2x11	257	160	149	70
KB2V6-32-32	51	2	-32	50,8	2x11	268	157	149	70

D9 Macho cilíndrico BSP
Rígido – Recto (Cono 60°)
BS5200 – AGR

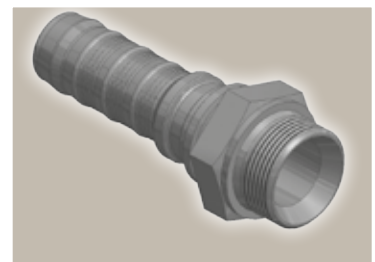
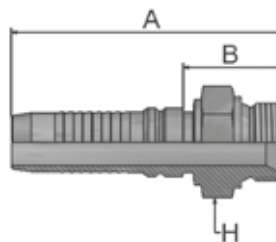

Referencia	D.I. de manguera				Rosca BSP	A mm	B mm	H mm
	DN	Pulg.	Tamaño	mm				
KD9V4-10-10	16	5/8	-10	15,9	5/8x14	94	35	30
KD9V4-12-12	19	3/4	-12	19,1	3/4x14	99	37,3	32
KD9V4-16-16	25	1	-16	25,4	1x11	115	42,7	41
KD9V4-20-20	31	1 1/4	-20	31,8	1 1/4x11	134	46,2	50
KD9V6-20-20	31	1 1/4	-20	31,8	1 1/4x11	139	48	50
KD9V4-24-24	38	1 1/2	-24	38,1	1 1/2x11	142	48,4	55
KD9V6-24-24	38	1 1/2	-24	38,1	1 1/2x11	155	58	55
KD9V4-32-32	51	2	-32	50,8	2x11	148	50	70
KD9V6-32-32	51	2	-32	50,8	2x11	168	58	70

Serie de terminales aprobados para tipos de manguera, dependiendo del tamaño:

- V4** H31 H31TC H31ST R42 42TC R42ST R35 R35TC RD35TC RS35TC R50TC R56TC H29 H29TC H29ST FA35
- V6** R35 R35TC RD35TC RS35TC R42 R42ST R42TC R50TC R56TC FA35

91 Macho cónico BSP Rígido - Recto

BS5200 - AGR-K

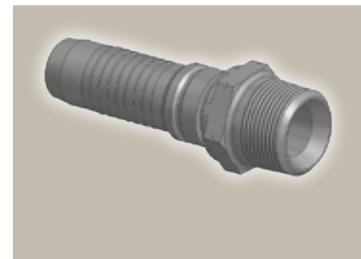
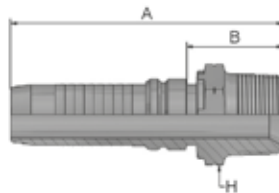

Referencia	D.I. de manguera				Rosca BSP	A mm	B mm	H mm
	DN	Pulg.	Tamaño	mm				
K91V4-12-12	19	3/4	-12	19,1	3/4x14	99	37	30
K91V4-16-16	25	1	-16	25,4	1x11	113	40	36
K91V4-20-20	31	1 1/4	-20	31,8	1 1/4x11	138	50	46
K91V4-24-24	38	1 1/2	-24	38,1	1 1/2x11	144	59	55
K91V4-32-32	51	2	-32	50,8	2x11	154	56	65

Serie de terminales aprobados para tipos de manguera, dependiendo del tamaño:

V4 H31 H31TC H31ST R42 42TC R42ST R35 R35TC RD35TC RS35TC R50TC R56TC H29 H29TC H29ST FA35

V6 R35 R35TC RD35TC RS35TC R42 R42ST R42TC R50TC R56TC FA35

01 Macho NPTF fijo Rígido – Recto

SAE J476A / J516 – AGN

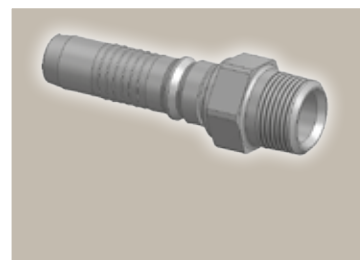
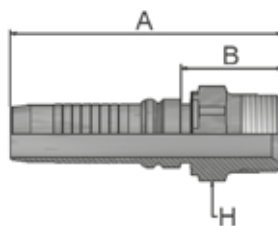

Referencia	D.I. de manguera				Rosca NPTF	A mm	B mm	H mm
	DN	Pulg.	Tamaño	mm				
K01V4-12-12	19	3/4	-12	19,1	3/4-14	100	38,3	30
K01V4-16-16	25	1	-16	25,4	1-11 1/2	116,5	43,9	36
K01V4-20-20	31	1 1/4	-20	31,8	1 1/4-11 1/2	146	58,2	46
K01V6-20-20	31	1 1/4	-20	31,8	1 1/4-11 1/2	151	60,2	46
K01V4-24-24	38	1 1/2	-24	38,1	1 1/2-11 1/2	148,4	55,3	50
K01V6-24-24	38	1 1/2	-24	38,1	1 1/2-11 1/2	159	62,7	50
K01V4-32-32	51	2	-32	50,8	2-11 1/2	159,8	62,3	65
K01V6-32-32	51	2	-32	50,8	2-11 1/2	181	70	65

03 Macho JIC 37° Rígido – Recto

ISO12151-5-S – AGJ

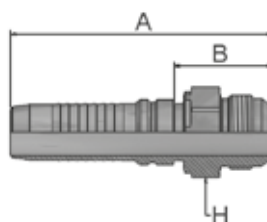

Referencia	D.I. de manguera				Rosca UNF	A mm	B mm	H mm
	DN	Pulg.	Tamaño	mm				
K03V4-12-12	19	3/4	-12	19,1	1 1/16x12	101	39,3	30
K03V4-16-12	19	3/4	-12	19,1	1 5/16x12	103	41,3	36
K03V4-16-16	25	1	-16	25,4	1 5/16x12	117	44,1	36
K03V4-20-16	25	1	-16	25,4	1 5/8x12	122	49,5	46
K03V4-20-20	31	1 1/4	-20	31,8	1 5/8x12	139	50,7	46
K03V4-24-20	31	1 1/4	-20	31,8	1 7/8x12	139	51	50
K03V6-20-20	31	1 1/4	-20	31,8	1 5/8x12	147	56	46
K03V4-24-24	38	1 1/2	-24	38,1	1 7/8x12	146	52,6	50
K03V6-24-24	38	1 1/2	-24	38,1	1 7/8x12	156	60	50
K03V4-32-32	51	2	-32	50,8	2 1/2x12	161	64	65
K03V6-32-32	51	2	-32	50,8	2 1/2x12	182	72	65

Serie de terminales aprobados para tipos de manguera, dependiendo del tamaño:

V4 H31 H31TC H31ST R42 42TC R42ST R35 R35TC RD35TC RS35TC R50TC R56TC H29 H29TC H29ST FA35

V6 R35 R35TC RD35TC RS35TC R42 R42ST R42TC R50TC R56TC FA35

06 Hembra giratoria JIC 37° Recta

ISO12151-5-SWS – DKJ

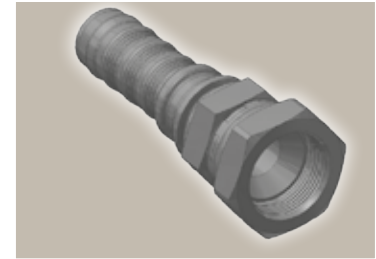
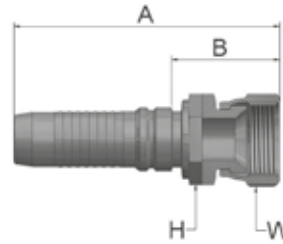

Referencia	D.I. de manguera				Rosca UNF	A mm	B mm	H mm	W mm
	DN	Pulg.	Tamaño	mm					
K06V4-12-12	19	3/4	-12	19,1	1 1/16x12	105	43	30	32
K06V4-16-12	19	3/4	-12	19,1	1 5/16x12	109	48	36	41
K06V4-16-16	25	1	-16	25,4	1 5/16x12	122	50	36	41
K06V4-20-16	25	1	-16	25,4	1 5/8x12	125	52	41	50
K06V4-20-20	31	1 1/4	-20	31,8	1 5/8x12	146	58	46	50
K06V4-24-20	31	1 1/4	-20	31,8	1 7/8x12	150	63	50	60
K06V6-20-20	31	1 1/4	-20	31,8	1 5/8x12	154	63	46	50
K06V6-24-20	31	1 1/4	-20	31,8	1 7/8x12	159	68	50	60
K06V4-24-24	38	1 1/2	-24	38,1	1 7/8x12	152	59	50	60
K06V6-24-24	38	1 1/2	-24	38,1	1 7/8x12	163	67	50	60
K06V4-32-32	51	2	-32	50,8	2 1/2x12	168	70	65	75
K06V6-32-32	51	2	-32	50,8	2 1/2x12	188	77	65	75

37 Hembra giratoria JIC 37° Codo 45°

ISO 12151-5-SWE 45° – DKJ 45°

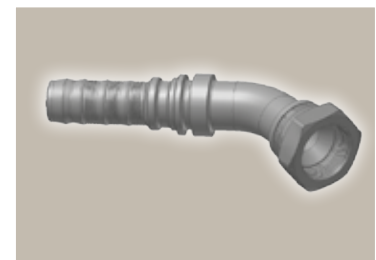
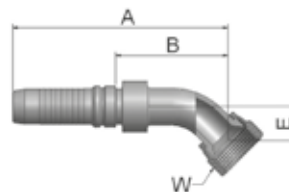

Referencia	D.I. de manguera				Rosca UNF	A mm	B mm	E mm	W mm
	DN	Pulg.	Tamaño	mm					
K37V4-12-12	19	3/4	-12	19,1	1 1/16x12	129	67	22	32
K37V4-16-16	25	1	-16	25,4	1 5/16x12	152	79,7	24	41
K37V4-20-20	31	1 1/4	-20	31,8	1 5/8x12	201	113	42	50
K37V6-20-20	31	1 1/4	-20	31,8	1 5/8x12	192	101	42	50
K37V4-24-24	38	1 1/2	-24	38,1	1 7/8x12	227	133,9	49	60
K37V6-24-24	38	1 1/2	-24	38,1	1 7/8x12	235	139	58	60
K37V4-32-32	51	2	-32	50,8	2 1/2x12	279	182	72	75
K37V6-32-32	51	2	-32	50,8	2 1/2x12	290	180	72	75

Serie de terminales aprobados para tipos de manguera, dependiendo del tamaño:



V4 H31 H31TC H31ST R42 42TC R42ST R35 R35TC RD35TC RS35TC R50TC R56TC H29 H29TC H29ST FA35

V6 R35 R35TC RD35TC RS35TC R42 R42ST R42TC R50TC R56TC FA35

39 Hembra giratoria JIC 37° Codo 90°

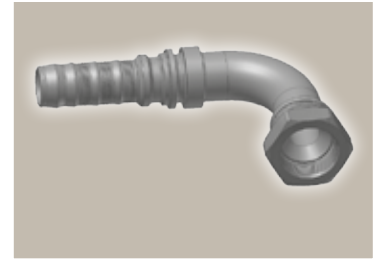
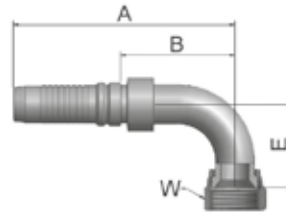
ISO 12151-5-SWES – DKJ 90°



Referencia	 D.I. de manguera				 Rosca UNF	A mm	B mm	E mm	 W mm
	DN	Pulg.	Tamaño	mm					
K39V4-12-12	19	3/4	-12	19,1	1 1/16x12	125	63,3	48	32
K39V4-16-12	19	3/4	-12	19,1	1 5/16x12	125	63,3	56	41
K39V4-16-16	25	1	-16	25,4	1 5/16x12	150	77,7	56	41
K39V4-20-16	25	1	-16	25,4	1 5/8x12	150	77	62	50
K39V4-20-20	31	1 1/4	-20	31,8	1 5/8x12	186	98	85	50
K39V4-24-20	31	1 1/4	-20	31,8	1 7/8x12	186	98	80	60
K39V6-20-20	31	1 1/4	-20	31,8	1 5/8x12	177	86	85	50
K39V4-24-24	38	1 1/2	-24	38,1	1 7/8x12	210	116,9	102	60
K39V6-24-24	38	1 1/2	-24	38,1	1 7/8x12	209	113	102	60
K39V4-32-32	51	2	-32	50,8	2 1/2x12	257	160	152	75
K39V6-32-32	51	2	-32	50,8	2 1/2x12	268	157	152	75

Serie de terminales aprobados para **tipos de manguera**, dependiendo del tamaño:

V4 H31 H31TC H31ST R42 42TC R42ST R35 R35TC RD35TC RS35TC R50TC R56TC H29 H29TC H29ST FA35

V6 R35 R35TC RD35TC RS35TC R42 R42ST R42TC R50TC R56TC FA35

15/4A Brida ISO 6162-1 Recta

ISO 12151-3-S-L – SFL
(35,0 MPa/ 5000 psi)

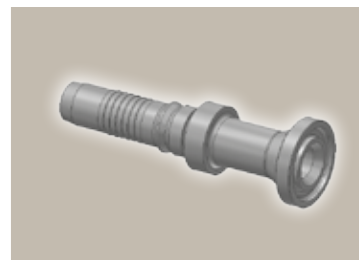
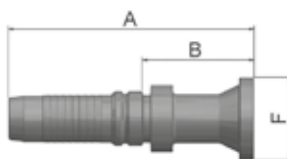

Referencia	D.I. de manguera				Terminal Pulg.	A mm	B mm	F mm
	DN	Pulg.	Tamaño	mm				
K15V4-12-12	19	3/4	-12	19,1	3/4	119	58	38
K15V4-16-12	19	3/4	-12	19,1	1	100	38,3	45
K15V4-12-16	25	1	-16	25,4	3/4	134,8	62,2	38
K15V4-16-16	25	1	-16	25,4	1	133	61	45
K4AV4-20-16	25	1	-16	25,4	1 1/4	101	28	51
K15V4-16-20	31	1 1/4	-20	31,8	1	152	64	45
K4AV4-20-20	31	1 1/4	-20	31,8	1 1/4	160	72	51
K4AV4-24-20	31	1 1/4	-20	31,8	1 1/2	126	38,7	60
K15V6-16-20	31	1 1/4	-20	31,8	1	161	70	44
K4AV6-20-20	31	1 1/4	-20	31,8	1 1/4	167	76	51
K4AV6-24-20	31	1 1/4	-20	31,8	1 1/2	165	74	60
K4AV4-20-24	38	1 1/2	-24	38,1	1 1/4	167	73	51
K4AV4-24-24	38	1 1/2	-24	38,1	1 1/2	190	97	60
K4AV4-32-24	38	1 1/2	-24	38,1	2	149	56	71
K4AV6-24-24	38	1 1/2	-24	38,1	1 1/2	201	105	60
K4AV6-32-24	38	1 1/2	-24	38,1	2	159	63	71
K4AV4-32-32	51	2	-32	50,8	2	189	92	71
K4AV6-32-32	51	2	-32	50,8	2	210	100	71

Serie de terminales aprobados para **tipos de manguera**, dependiendo del tamaño:



V4 H31 H31TC H31ST R42 42TC R42ST R35 R35TC RD35TC RS35TC R50TC R56TC H29 H29TC H29ST FA35

V6 R35 R35TC RD35TC RS35TC R42 R42ST R42TC R50TC R56TC FA35

17/4F Brida ISO 6162-1 Codo 45°

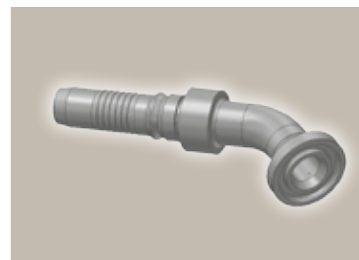
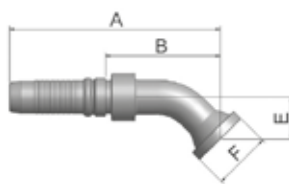
ISO 12151-3 – E45S – L – SFL 45°
(35,0 MPa/ 5000 psi)



Referencia	 D.I. de manguera				 Terminal	A mm	B mm	E mm	F mm
	DN	Pulg.	Tamaño	mm	Pulg.				
K17V4-12-12	19	3/4	-12	19,1	3/4	133	72	26	38
K17V4-16-12	19	3/4	-12	19,1	1	133	72	26	45
K4FV4-20-12	19	3/4	-12	19,1	1 1/4	133	71	25	51
K17V4-16-16	25	1	-16	25,4	1	160	87	32	45
K4FV4-20-16	25	1	-16	25,4	1 1/4	160	87	32	51
K17V4-16-20	31	1 1/4	-20	31,8	1	198	109,7	38	45
K4FV4-20-20	31	1 1/4	-20	31,8	1 1/4	198	109,7	38	51
K4FV4-24-20	31	1 1/4	-20	31,8	1 1/2	198	109,7	38	60
K17V6-16-20	31	1 1/4	-20	31,8	1	188	97	38	44
K4FV6-20-20	31	1 1/4	-20	31,8	1 1/4	188	97	38	51
K4FV6-24-20	31	1 1/4	-20	31,8	1 1/2	188	97	38	60
K4FV4-24-24	38	1 1/2	-24	38,1	1 1/2	222	128,9	44	60
K4FV4-32-24	38	1 1/2	-24	38,1	2	222	128,9	44	71
K4FV6-20-24	38	1 1/2	-24	38,1	1 1/4	201	105	44	51
K4FV6-24-24	38	1 1/2	-24	38,1	1 1/2	221	125	44	60
K4FV6-32-24	38	1 1/2	-24	38,1	2	221	125	44	71
K4FV4-32-32	51	2	-32	50,8	2	269	171	62	71
K4FV6-32-32	51	2	-32	50,8	2	280	169	62	71

Serie de terminales aprobados para tipos de manguera, dependiendo del tamaño:

V4 H31 H31TC H31ST R42 42TC R42ST R35 R35TC RD35TC RS35TC R50TC R56TC H29 H29TC H29ST FA35

V6 R35 R35TC RD35TC RS35TC R42 R42ST R42TC R50TC R56TC FA35

19/4N Brida ISO 6162-1 Codo 90°

ISO 12151-3-E-L – SFL 90°
(35,0 MPa/ 5000 psi)

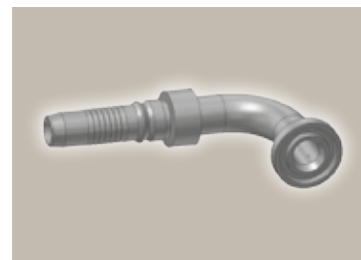
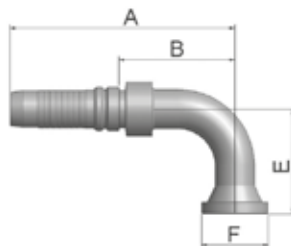

Referencia	D.I. de manguera				Terminal Pulg.	A mm	B mm	E mm	F mm
	DN	Pulg.	Tamaño	mm					
K19V4-12-12	19	3/4	-12	19,1	3/4	125	63,3	58	38
K19V4-16-12	19	3/4	-12	19,1	1	125	63,3	58	45
K19V4-16-16	25	1	-16	25,4	1	150	77,7	70	45
K4NV4-20-16	25	1	-16	25,4	1 1/4	150	77	69	51
K19V4-16-20	31	1 1/4	-20	31,8	1	186	98	90	45
K4NV4-20-20	31	1 1/4	-20	31,8	1 1/4	186	98,2	90	51
K4NV4-24-20	31	1 1/4	-20	31,8	1 1/2	186	98	90	60
K4NV4-24-20-SL110	31	1 1/4	-20	31,8	1 1/2	186	98	110	60
K19V6-16-20	31	1 1/4	-20	31,8	1	177	86	90	44
K4NV6-20-20	31	1 1/4	-20	31,8	1 1/4	177	86	90	51
K4NV6-24-20	31	1 1/4	-20	31,8	1 1/2	177	86	90	60
K4NV4-20-24	38	1 1/2	-24	38,1	1 1/4	197	103	104	51
K4NV4-24-24	38	1 1/2	-24	38,1	1 1/2	210	116,9	104	60
K4NV4-24-24-SL150	38	1 1/2	-24	38,1	1 1/2	210	116,9	150	60
K4NV4-24-24-SL200	38	1 1/2	-24	38,1	1 1/2	210	116,9	200	60
K4NV4-32-24	38	1 1/2	-24	38,1	2	210	116,9	104	71
K4NV6-20-24	38	1 1/2	-24	38,1	1 1/4	184	88	104	51
K4NV6-24-24	38	1 1/2	-24	38,1	1 1/2	209	113	104	60
K4NV6-32-24	38	1 1/2	-24	38,1	2	209	113	104	71
K4NV4-24-32	51	2	-32	50,8	1 1/2	227	130	138	60
K4NV4-32-32	51	2	-32	50,8	2	257	160,2	138	71
K4NV6-32-32	51	2	-32	50,8	2	268	157	138	71



Serie de terminales aprobados para tipos de manguera, dependiendo del tamaño:

- V4** H31 H31TC H31ST R42 42TC R42ST R35 R35TC RD35TC RS35TC R50TC R56TC H29 H29TC H29ST FA35
- V6** R35 R35TC RD35TC RS35TC R42 R42ST R42TC R50TC R56TC FA35

6A Brida ISO 6162-2 Recta

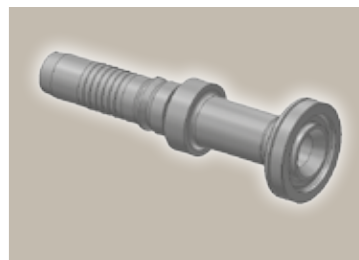
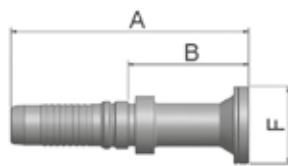
ISO 12151-3-S-S – SFS
(42,0 MPa/ 6000 psi)



Referencia	 D.I. de manguera				 Terminal	A mm	B mm	F mm
	DN	Pulg.	Tamaño	mm	Pulg.			
K6AV4-8-10	16	5/8	-10	15,9	1/2	121	62	32
K6AV4-12-10	16	5/8	-10	15,9	3/4	94	33,8	41
K6AV4-12-12	19	3/4	-12	19,1	3/4	126	64,4	41
K6AV4-16-12	19	3/4	-12	19,1	1	100	38	48
K6AV4-12-16	25	1	-16	25,4	3/4	150	77	41
K6AV4-16-16	25	1	-16	25,4	1	148	75	48
K6AV4-20-16	25	1	-16	25,4	1 1/4	116	44	54
K6AV4-24-16	25	1	-16	25,4	1 1/2	118	45	64
K6AV4-16-20	31	1 1/4	-20	31,8	1	166	78	48
K6AV4-20-20	31	1 1/4	-20	31,8	1 1/4	166	78	54
K6AV4-24-20	31	1 1/4	-20	31,8	1 1/2	139	51	64
K6AV6-16-20	31	1 1/4	-20	31,8	1	175	84	48
K6AV6-20-20	31	1 1/4	-20	31,8	1 1/4	175	83	54
K6AV6-24-20	31	1 1/4	-20	31,8	1 1/2	147	56	64
K6AV4-20-24	38	1 1/2	-24	38,1	1 1/4	174	81	54
K6AV4-24-24	38	1 1/2	-24	38,1	1 1/2	192	99	64
K6AV4-32-24	38	1 1/2	-24	38,1	2	184	91	79
K6AV6-20-24	38	1 1/2	-24	38,1	1 1/4	185	89	54
K6AV6-24-24	38	1 1/2	-24	38,1	1 1/2	202	106	64
K6AV6-32-24	38	1 1/2	-24	38,1	2	194	98	79
K6AV4-24-32	51	2	-32	50,8	1 1/2	198	101	64
K6AV4-32-32	51	2	-32	50,8	2	212	115	79
K6AV6-24-32	51	2	-32	50,8	1 1/2	219	108,3	64
K6AV6-32-32	51	2	-32	50,8	2	233	122	79
K6AV6-32-40	63	2 1/2	-40	63,5	2	252	117	79
K6AV6-40-40	63	2 1/2	-40	63,5	2 1/2	253	118	108
K6AV6-48-40	63	2 1/2	-40	63,5	3	250	115	132
K6AV6-48-48	76	3	-48	76,2	3	240	133	132

Serie de terminales aprobados para **tipos de manguera**, dependiendo del tamaño:

V4 H31 H31TC H31ST R42 42TC R42ST R35 R35TC RD35TC RS35TC R50TC R56TC H29 H29TC H29ST FA35

V6 R35 R35TC RD35TC RS35TC R42 R42ST R42TC R50TC R56TC FA35

6F Brida ISO 6162-2 Codo 45°

ISO 12151-3 – E45-S – SFS 45°
(42,0 MPa/ 6000 psi)

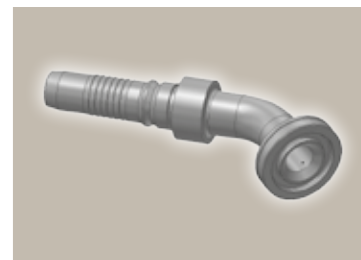
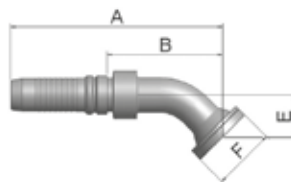

Referencia	D.I. de manguera				Terminal Pulg.	A mm	B mm	E mm	F mm
	DN	Pulg.	Tamaño	mm					
K6FV4-8-10	16	5/8	-10	15,9	1/2	123	63,3	26	32
K6FV4-12-10	16	5/8	-10	15,9	3/4	123	63,3	26	41
K6FV4-12-12	19	3/4	-12	19,1	3/4	133	72	26	41
K6FV4-12-12-SL55	19	3/4	-12	19,1	3/4	162	101	55	41
K6FV4-16-12	19	3/4	-12	19,1	1	133	71,3	26	48
K6FV4-16-12-SL55	19	3/4	-12	19,1	1	162	101	55	48
K6FV4-12-16	25	1	-16	25,4	3/4	155	78	32	41
K6FV4-16-16	25	1	-16	25,4	1	160	87	32	48
K6FV4-16-16-SL55	25	1	-16	25,4	1	183	110	55	48
K6FV4-20-16	25	1	-16	25,4	1 1/4	161	88,7	32	54
K6FV4-20-16-SL55	25	1	-16	25,4	1 1/4	184	112	55	54
K6FV4-16-20	31	1 1/4	-20	31,8	1	198	109,7	38	48
K6FV4-20-20	31	1 1/4	-20	31,8	1 1/4	198	109,7	38	54
K6FV4-20-20-SL60	31	1 1/4	-20	31,8	1 1/4	220	132	60	54
K6FV4-24-20	31	1 1/4	-20	31,8	1 1/2	198	109,7	38	64
K6FV4-24-20-SL60	31	1 1/4	-20	31,8	1 1/2	220	132	60	64
K6FV6-16-20	31	1 1/4	-20	31,8	1	188	97	38	48
K6FV6-20-20	31	1 1/4	-20	31,8	1 1/4	189	97,3	38	54
K6FV6-20-20-SL60	31	1 1/4	-20	31,8	1 1/4	210	119	60	54
K6FV6-24-20	31	1 1/4	-20	31,8	1 1/2	189	97,3	38	64
K6FV4-24-24	38	1 1/2	-24	38,1	1 1/2	222	128,9	44	64
K6FV4-24-24-SL70	38	1 1/2	-24	38,1	1 1/2	248	155	70	64
K6FV4-32-24	38	1 1/2	-24	38,1	2	222	128,9	44	79
K6FV6-20-24	38	1 1/2	-24	38,1	1 1/4	209	113,3	44	54
K6FV6-24-24	38	1 1/2	-24	38,1	1 1/2	221	125,3	44	64
K6FV6-24-24-SL70	38	1 1/2	-24	38,1	1 1/2	247	151	70	64
K6FV6-32-24	38	1 1/2	-24	38,1	2	221	125,3	44	79
K6FV4-32-32	51	2	-32	50,8	2	263	166	56	79
K6FV4-32-32-SL70	51	2	-32	50,8	2	277	180	70	79
K6FV6-24-32	51	2	-32	50,8	1 1/2	260	149,3	56	64
K6FV6-32-32	51	2	-32	50,8	2	274	163,3	56	79

Serie de terminales aprobados para tipos de manguera, dependiendo del tamaño:

V4 H31 H31TC H31ST R42 42TC R42ST R35 R35TC RD35TC RS35TC R50TC R56TC H29 H29TC H29ST FA35

V6 R35 R35TC RD35TC RS35TC R42 R42ST R42TC R50TC R56TC FA35

6N Brida ISO 6162-2 Codo 90°

ISO 12151-3 – E-S – SFS 90°
(42,0 MPa/ 6000 psi)

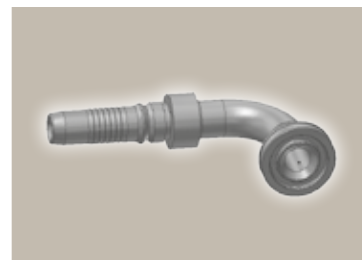
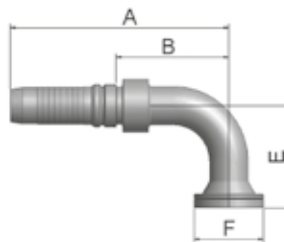

Referencia	D.I. de manguera				Terminal	A	B	E	F
	DN	Pulg.	Tamaño	mm					
K6NV4-8-10	16	5/8	-10	15,9	1/2	111	51	54	32
K6NV4-12-10	16	5/8	-10	15,9	3/4	111	50,3	54	41
K6NV4-12-12	19	3/4	-12	19,1	3/4	125	63,3	58	41
K6NV4-12-12-SL100	19	3/4	-12	19,1	3/4	125	63	100	41
K6NV4-16-12	19	3/4	-12	19,1	1	125	63,3	58	48
K6NV4-16-12-SL100	19	3/4	-12	19,1	1	125	63	100	48
K6NV4-12-16	25	1	-16	25,4	3/4	140	67	70	41
K6NV4-12-16-SL55	25	1	-16	25,4	3/4	140	67	55	41
K6NV4-16-16	25	1	-16	25,4	1	150	77,7	70	48
K6NV4-16-16-SL100	25	1	-16	25,4	1	150	77	100	48
K6NV4-20-16	25	1	-16	25,4	1 1/4	154	81	70	54
K6NV4-20-16-SL115	25	1	-16	25,4	1 1/4	154	81	115	54
K6NV4-16-20	31	1 1/4	-20	31,8	1	186	98,7	90	48
K6NV4-20-20	31	1 1/4	-20	31,8	1 1/4	186	98,7	90	54
K6NV4-20-20-SL120	31	1 1/4	-20	31,8	1 1/4	186	98	120	54
K6NV4-20-20-SL330	31	1 1/4	-20	31,8	1 1/4	186	98	330	54
K6NV4-24-20	31	1 1/4	-20	31,8	1 1/2	186	98,7	90	64
K6NV4-24-20-SL135	31	1 1/4	-20	31,8	1 1/2	186	98	135	64
K6NV6-16-20	31	1 1/4	-20	31,8	1	177	86	90	48
K6NV6-20-20	31	1 1/4	-20	31,8	1 1/4	177	86,3	90	54
K6NV6-20-20-SL120	31	1 1/4	-20	31,8	1 1/4	177	86	120	54
K6NV6-24-20	31	1 1/4	-20	31,8	1 1/2	177	86,3	90	64
K6NV4-20-24	38	1 1/2	-24	38,1	1 1/4	197	103,9	104	54
K6NV4-24-24	38	1 1/2	-24	38,1	1 1/2	210	116,9	104	64
K6NV4-24-24-SL140	38	1 1/2	-24	38,1	1 1/2	210	117	140	64
K6NV4-24-24-SL160	38	1 1/2	-24	38,1	1 1/2	210	117	160	64
K6NV4-24-24-SL200	38	1 1/2	-24	38,1	1 1/2	210	117	200	64
K6NV4-32-24	38	1 1/2	-24	38,1	2	210	116,9	104	79
K6NV6-20-24	38	1 1/2	-24	38,1	1 1/4	192	96,3	104	54
K6NV6-24-24	38	1 1/2	-24	38,1	1 1/2	210	113,3	104	64
K6NV6-32-24	38	1 1/2	-24	38,1	2	209	113,3	104	79
K6NV4-24-32	51	2	-32	50,8	1 1/2	221	124	104	64
K6NV4-32-32	51	2	-32	50,8	2	257	160	138	79
K6NV6-24-32	51	2	-32	50,8	1 1/2	236	125,3	104	64
K6NV6-32-32	51	2	-32	50,8	2	268	157,3	138	79

Serie de terminales aprobados para tipos de manguera, dependiendo del tamaño:

V4 H31 H31TC H31ST R42 42TC R42ST R35 R35TC RD35TC RS35TC R50TC R56TC H29 H29TC H29ST FA35

V6 R35 R35TC RD35TC RS35TC R42 R42ST R42TC R50TC R56TC FA35

8A Brida - Recta

8000 psi

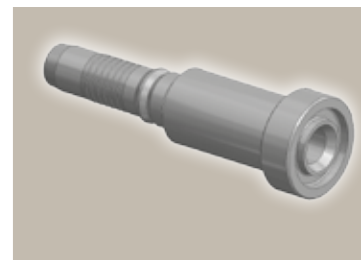
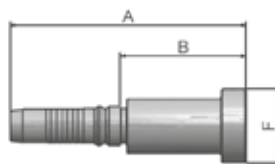

Referencia	D.I. de manguera				Terminal Pulg.	A mm	B mm	F mm
	DN	Pulg.	Tamaño	mm				
K8AV4-12-10	16	5/8	-10	15,9	3/4	130	71	41
K8AV4-12-12	19	3/4	-12	19,1	3/4	132	71	41
K8AV4-16-12	19	3/4	-12	19,1	1	143	82	48
K8AV4-16-16	25	1	-16	25,4	1	148	75	48
K8AV4-20-16	25	1	-16	25,4	1 1/4	111	39	54
K8AV6-20-20	31	1 1/4	-20	31,8	1 1/4	190	88	54

8F Brida - Codo 45°

8000 psi

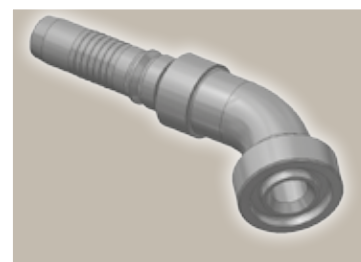
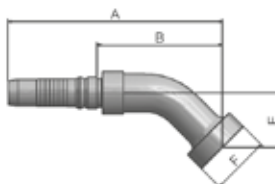

Referencia	D.I. de manguera				Terminal Pulg.	A mm	B mm	E mm	F mm
	DN	Pulg.	Tamaño	mm					
K8FV4-12-10	16	5/8	-10	15,9	3/4	123	64	26	41
K8FV4-12-12	19	3/4	-12	19,1	3/4	138	76	26	41
K8FV4-16-12	19	3/4	-12	19,1	1	143	81	32	48
K8FV4-16-16	25	1	-16	25,4	1	178	105	35	48
K8FV4-20-16	25	1	-16	25,4	1 1/4	178	105	35	54
K8FV6-20-20	31	1 1/4	-20	31,8	1 1/4	194	103	38	54

Serie de terminales aprobados para tipos de manguera, dependiendo del tamaño:

V4 H31 H31TC H31ST R42 42TC R42ST R35 R35TC RD35TC RS35TC R50TC R56TC H29 H29TC H29ST FA35

V6 R35 R35TC RD35TC RS35TC R42 R42ST R42TC R50TC R56TC FA35

8N Brida – Codo 90°

8000 psi

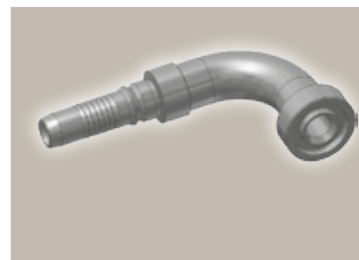
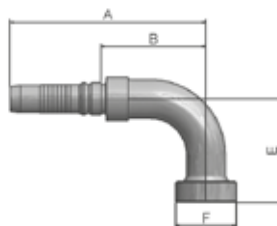

Referencia	D.I. de manguera				Terminal Pulg.	A mm	B mm	E mm	F mm
	DN	Pulg.	Tamaño	mm					
K8NV4-12-10	16	5/8	-10	15,9	3/4	111	51	58	41
K8NV4-12-12	19	3/4	-12	19,1	3/4	133	71	70	41
K8NV4-16-12	19	3/4	-12	19,1	1	133	71	70	48
K8NV4-16-16	25	1	-16	25,4	1	170	97	75	48
K8NV4-20-16	25	1	-16	25,4	1 1/4	170	97	90	54
K8NV6-20-20	31	1 1/4	-20	31,8	1 1/4	182	91	90	54

X5 Brida

Sistema completo de brida
ISO 6162-1 o ISO 6162-2

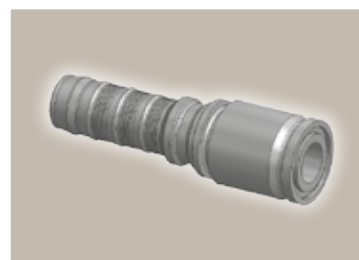
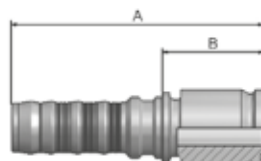

Referencia	D.I. de manguera				Terminal Pulg.	A mm	B mm
	DN	Pulg.	Tamaño	mm			
KX5V6-20-20	31	1 1/4	-20	31,8	1 1/4	152,3	61,3
KX5V6-24-24	38	1 1/2	-24	38,1	1 1/2	159,3	63,3
KX5V6-32-32	51	2	-32	50,8	2	188	78
KX5V6-40-40	63	2 1/2	-40	63,5	2 1/2	233	83
KX5V6-48-40	63	2 1/2	-40	63,5	3	233	98

Serie de terminales aprobados para tipos de manguera, dependiendo del tamaño:

V4 H31 H31TC H31ST R42 42TC R42ST R35 R35TC RD35TC RS35TC R50TC R56TC H29 H29TC H29ST FA35

V6 R35 R35TC RD35TC RS35TC R42 R42ST R42TC R50TC R56TC FA35

X7 Brida - Codo 45°

Sistema completo de brida
ISO 6162-1 or ISO 6162-2

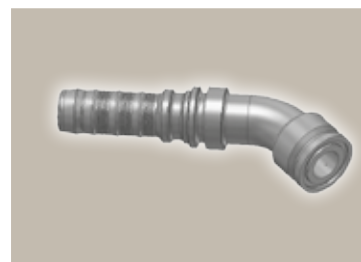
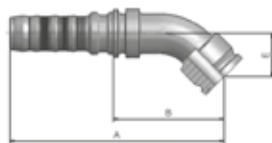

Referencia	D.I. de manguera				Terminal Pulg.	A mm	B mm	E mm
	DN	Pulg.	Tamaño	mm				
KX7V6-20-20	31	1 1/4	-20	31,8	1 1/4	190	99	39
KX7V6-24-24	38	1 1/2	-24	38,1	1 1/2	221	125	44
KX7V6-32-32	51	2	-32	50,8	2	275	164,5	57

X9 Brida - Codo 90°

Sistema completo de brida
ISO 6162-1 or ISO 6162-2

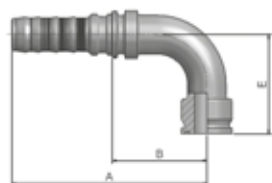

Referencia	D.I. de manguera				Terminal Pulg.	A mm	B mm	E mm
	DN	Pulg.	Tamaño	mm				
KX9V6-20-20	31	1 1/4	-20	31,8	1 1/4	176,8	85,5	90
KX9V6-24-24	38	1 1/2	-24	38,1	1 1/2	209,3	113	104
KX9V6-32-32	51	2	-32	50,8	2	268	157	138

Serie de terminales aprobados para tipos de manguera, dependiendo del tamaño:

V4 H31 H31TC H31ST R42 42TC R42ST R35 R35TC RD35TC RS35TC R50TC R56TC H29 H29TC H29ST FA35

V6 R35 R35TC RD35TC RS35TC R42 R42ST R42TC R50TC R56TC FA35

PY Brida - Macho 24°
Gas Francés
Recta

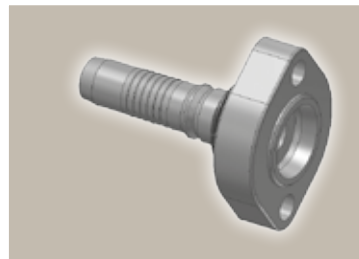
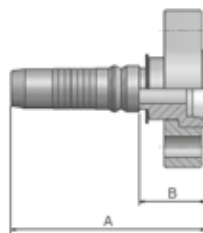

Referencia	D.I. de manguera				A mm	B mm
	DN	Pulg.	Tamaño	mm		
KPYV4-12-12	19	3/4	-12	19,1	92	30
KPYV4-16-16	25	1	-16	25,4	112	39

XA Brida Caterpillar®
Recta

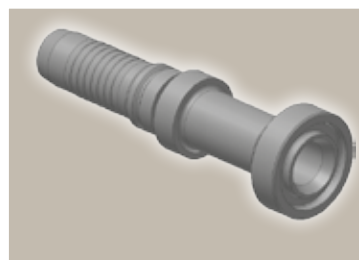
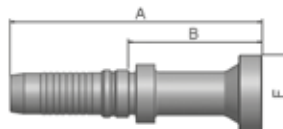

Referencia	D.I. de manguera				Terminal Pulg.	A mm	B mm	F mm
	DN	Pulg.	Tamaño	mm				
KXAV4-12-12	19	3/4	-12	19,1	3/4	132	71	41
KXAV4-16-12	19	3/4	-12	19,1	1	144	82	48
KXAV4-16-16	25	1	-16	25,4	1	155	82	48
KXAV4-20-16	25	1	-16	25,4	1 1/4	160	88	54
KXAV6-20-20	31	1 1/4	-20	31,8	1 1/4	181	90	54
KXAV6-24-20	31	1 1/4	-20	31,8	1 1/2	188	97	64
KXAV6-24-24	38	1 1/2	-24	38,1	1 1/2	207	111	64

Serie de terminales aprobados para tipos de manguera, dependiendo del tamaño:

V4	H31 H31TC H31ST R42 42TC R42ST R35 R35TC RD35TC RS35TC R50TC R56TC H29 H29TC H29ST FA35
V6	R35 R35TC RD35TC RS35TC R42 R42ST R42TC R50TC R56TC FA35

XF **Brida Caterpillar®**
Codo 45°

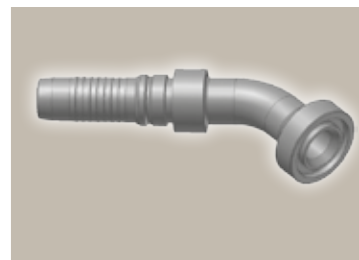
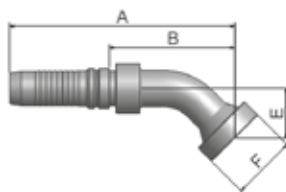

Referencia	D.I. de manguera				Terminal Pulg.	A mm	B mm	E mm	F mm
	DN	Pulg.	Tamaño	mm					
KXFV4-12-12	19	3/4	-12	19,1	3/4	138	76	31	41
KXFV4-16-16	25	1	-16	25,4	1	164	91	36	48
KXFV4-20-16	25	1	-16	25,4	1 1/4	164	92	35	54
KXFV6-20-20	31	1 1/4	-20	31,8	1 1/4	187	96	37	54
KXFV6-24-20	31	1 1/4	-20	31,8	1 1/2	187	96	37	64
KXFV6-24-24	38	1 1/2	-24	38,1	1 1/2	216	120	39	64

XG **Brida Caterpillar®**
Codo 60°

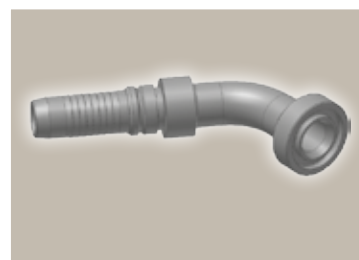
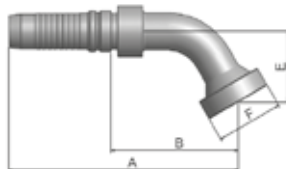



Referencia	D.I. de manguera				Terminal Pulg.	A mm	B mm	E mm	F mm
	DN	Pulg.	Tamaño	mm					
KXGV4-16-12	19	3/4	-12	19,1	1	152	91	42	48
KXGV4-16-16	25	1	-16	25,4	1	182	109	50	48
KXGV4-20-16	25	1	-16	25,4	1 1/4	184	112	50	54
KXGV6-20-20	31	1 1/4	-20	31,8	1 1/4	206	115	55	54
KXGV6-24-20	31	1 1/4	-20	31,8	1 1/2	208	117	52	64
KXGV6-24-24	38	1 1/2	-24	38,1	1 1/2	266	170	52	64

Serie de terminales aprobados para **tipos de manguera**, dependiendo del tamaño:

- V4** H31 H31TC H31ST R42 42TC R42ST R35 R35TC RD35TC RS35TC R50TC R56TC H29 H29TC H29ST FA35
- V6** R35 R35TC RD35TC RS35TC R42 R42ST R42TC R50TC R56TC FA35

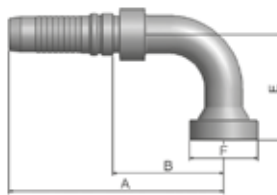
XN Brida Caterpillar®
Codo 90°



Referencia	 D.I. de manguera				 Terminal	A mm	B mm	E mm	F mm
	DN	Pulg.	Tamaño	mm	Pulg.				
KXNV4-12-12	19	3/4	-12	19,1	3/4	125	63	63	41
KXNV4-16-12	19	3/4	-12	19,1	1	125	63	62	48
KXNV4-16-16	25	1	-16	25,4	1	150	77	74	48
KXNV4-20-16	25	1	-16	25,4	1 1/4	154	81	74	54
KXNV6-20-20	31	1 1/4	-20	31,8	1 1/4	177	86	77	54
KXNV6-24-20	31	1 1/4	-20	31,8	1 1/2	177	86	77	64
KXNV6-24-24	38	1 1/2	-24	38,1	1 1/2	209	113	106	64

Serie de terminales aprobados para tipos de manguera, dependiendo del tamaño:

V4 H31 H31TC H31ST R42 42TC R42ST R35 R35TC RD35TC RS35TC R50TC R56TC H29 H29TC H29ST FA35

V6 R35 R35TC RD35TC RS35TC R42 R42ST R42TC R50TC R56TC FA35

JC Hembra giratoria ORFS Recta - Corta

ISO 12151-1 - SWSA
SAE J516 - ORFS

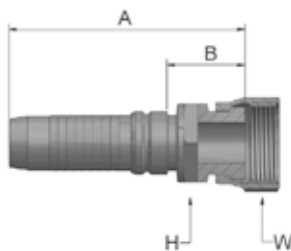

Referencia	D.I. de manguera				Rosca UNF	A mm	B mm	H mm	W mm
	DN	Pulg.	Tamaño	mm					
KJCV4-12-12	19	3/4	-12	19,1	1 3/16x12	93	31,3	30	36
KJCV4-16-12	19	3/4	-12	19,1	1 7/16x12	93	31	36	41
KJCV4-12-16	25	1	-16	25,4	1 3/16x12	101	29	36	36
KJCV4-16-16	25	1	-16	25,4	1 7/16x12	108	36	36	41
KJCV4-20-16	25	1	-16	25,4	1 11/16x12	120	47	41	50
KJCV4-20-20	31	1 1/4	-20	31,8	1 11/16x12	127	39	46	50
KJCV6-20-20	31	1 1/4	-20	31,8	1 11/16x12	132	41	46	50
KJCV6-24-20	31	1 1/4	-20	31,8	2x12	133	42	50	60
KJCV4-24-24	38	1 1/2	-24	38,1	2x12	131	37,9	50	60
KJCV6-24-24	38	1 1/2	-24	38,1	2x12	140	44	50	60

JS Hembra giratoria ORFS (Larga)

ISO 12151-1-SWSB
SAE J516 - ORFS

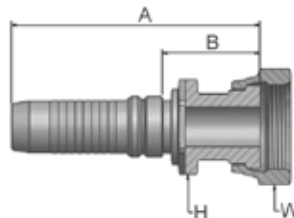

Referencia	D.I. de manguera				Rosca UNF	A mm	B mm	H mm	W mm
	DN	Pulg.	Tamaño	mm					
KJSV4-16-16	25	1	-16	25,4	1 7/16x12	121	49	36	41
KJSV4-20-16	25	1	-16	25,4	1 11/16x12	120	47,7	41	50
KJSV4-20-20	31	1 1/4	-20	31,8	1 11/16x12	137	49,7	41	50

Serie de terminales aprobados para **tipos de manguera**, dependiendo del tamaño:

V4 H31 H31TC H31ST R42 42TC R42ST R35 R35TC RD35TC RS35TC R50TC R56TC H29 H29TC H29ST FA35

V6 R35 R35TC RD35TC RS35TC R42 R42ST R42TC R50TC R56TC FA35

J7 Hembra giratoria ORFS Codo 45°

ISO 12151-1 – SWE 45°
SAE J516 – ORFS 45°

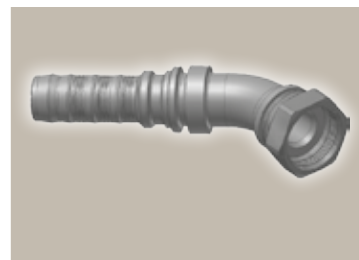
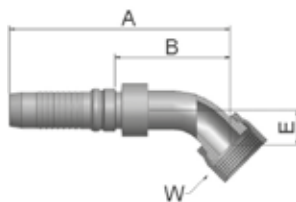

Referencia	D.I. de manguera				Rosca UNF	A mm	B mm	E mm	W mm
	DN	Pulg.	Tamaño	mm					
KJ7V4-12-12	19	3/4	-12	19,1	1 3/16x12	128	66,3	21	36
KJ7V4-16-12	19	3/4	-12	19,1	1 7/16x12	131	70	24	41
KJ7V4-16-16	25	1	-16	25,4	1 7/16x12	152	79	24	41
KJ7V4-20-16	25	1	-16	25,4	1 11/16x12	154	81	26	50
KJ7V4-20-20	31	1 1/4	-20	31,8	1 11/16x12	189	101,7	30	50
KJ7V6-20-20	31	1 1/4	-20	31,8	1 11/16x12	179	87,8	33	50
KJ7V6-24-20	31	1 1/4	-20	31,8	2x12	190	99	40	60
KJ7V4-24-24	38	1 1/2	-24	38,1	2x12	218	124,9	40	60
KJ7V6-24-24	38	1 1/2	-24	38,1	2x12	216	120	40	60

J9 Hembra giratoria ORFS Codo 90° – Corto

ISO 12151-1 – SWES
SAE J516 – ORFS 90°

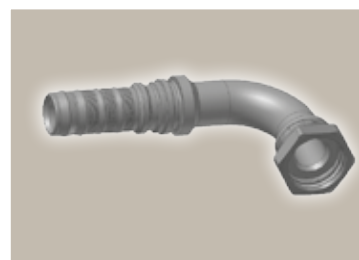
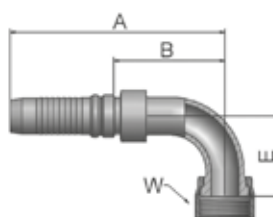

Referencia	D.I. de manguera				Rosca UNF	A mm	B mm	E mm	W mm
	DN	Pulg.	Tamaño	mm					
KJ9V4-12-12	19	3/4	-12	19,1	1 3/16x12	125	63,3	48	36
KJ9V4-16-12	19	3/4	-12	19,1	1 7/16x12	125	63	56	41
KJ9V4-16-16	25	1	-16	25,4	1 7/16x12	150	77,7	56	41
KJ9V4-20-16	25	1	-16	25,4	1 11/16x12	150	77	64	50
KJ9V4-20-20	31	1 1/4	-20	31,8	1 11/16x12	186	98	69	50
KJ9V6-20-20	31	1 1/4	-20	31,8	1 11/16x12	177	86	79	50
KJ9V6-24-20	31	1 1/4	-20	31,8	2x12	177	86	70	60
KJ9V4-24-24	38	1 1/2	-24	38,1	2x12	210	116,9	82	60
KJ9V6-24-24	38	1 1/2	-24	38,1	2x12	202	106	87	60



Serie de terminales aprobados para **tipos de manguera**, dependiendo del tamaño:

V4 H31 H31TC H31ST R42 42TC R42ST R35 R35TC RD35TC RS35TC R50TC R56TC H29 H29TC H29ST FA35

V6 R35 R35TC RD35TC RS35TC R42 R42ST R42TC R50TC R56TC FA35

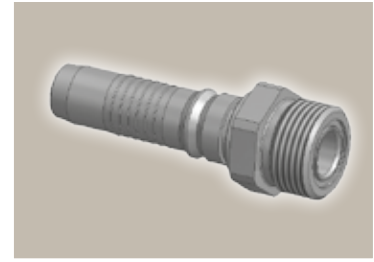
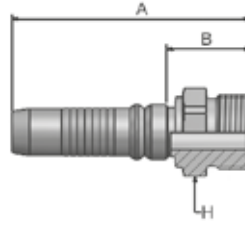
JM Macho ORFS
ISO 12151-1-S – SAE J516



Referencia	 D.I. de manguera				 Rosca UNF	A mm	B mm	 H mm
	DN	Pulg.	Tamaño	mm				
KJMV4-12-12	19	3/4	-12	19,1	1 3/16x12	95	33,3	32
KJMV4-16-12	19	3/4	-12	19,1	1 7/16x12	98,7	37	41

Serie de terminales aprobados para **tipos de manguera**, dependiendo del tamaño:

V4 H31 H31TC H31ST R42 42TC R42ST R35 R35TC RD35TC RS35TC R50TC R56TC H29 H29TC H29ST FA35

V6 R35 R35TC RD35TC RS35TC R42 R42ST R42TC R50TC R56TC FA35

FG Macho Gaz francés Rígido Recto (Cono 24°)

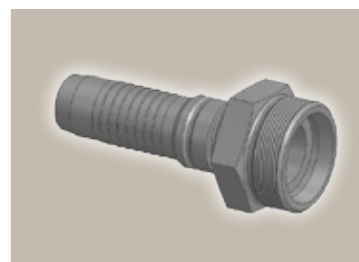
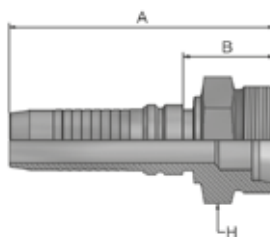

Referencia	D.I. de manguera				Rosca métrica	Tubo D.E. mm	A mm	B mm	H mm
	DN	Pulg.	Tamaño	mm					
KFGV4-27-12	19	3/4	-12	19,1	M36x1,5	26,75	94	32,3	36
KFGV4-33-16	25	1	-16	25,4	M45x1,5	33,5	111	38,7	46

F4 Hembra giratoria francesa Serie Gaz Recta (Asiento ovalado)

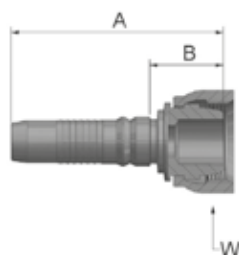

Referencia	D.I. de manguera				Rosca métrica	Tubo D.E. mm	A mm	B mm	W mm
	DN	Pulg.	Tamaño	mm					
KF4V4-27-12	19	3/4	-12	19,1	M36x1,5	26,75	95	33	46

Serie de terminales aprobados para **tipos de manguera**, dependiendo del tamaño:

V4 H31 H31TC H31ST R42 42TC R42ST R35 R35TC RD35TC RS35TC R50TC R56TC H29 H29TC H29ST FA35

V6 R35 R35TC RD35TC RS35TC R42 R42ST R42TC R50TC R56TC FA35

ADAPTADORES



Terminales
Parkrimp®

Equipo de montaje
Parkrimp®



Aplicaciones para móvil



Parker Tracking System



Programa Contenedor
ParkerStore Onsite y
Servicio Hose Doctor



Montajes y terminales
a medida



Accesorios

Union Doble Macho Rosca BSP

REFERENCIA	A	B	L	C	D	EX
H8050510-02-02	1/8"-28	1/8"-28	26,5	9	9	14
H8050510-04-02	1/4"-19	1/8"-28	28,5	11	9	19
H8050510-06-02	3/8"-19	1/8"-28	32	12	9	22
H8050510-04-04	1/4"-19	1/4"-19	32	11	11	19
H8805010-06-04	3/8"-19	1/4"-19	33,5	12	11	22
H8050510-08-04	1/2"-14	1/4"-19	36,5	14	11	27
H8050510-06-06	3/8"-19	3/8"-19	35	12	12	22
H8050510-08-06	1/2"-14	3/8"-19	38	14	12	27
H8050510-10-06	5/8"-14	3/8"-19	40,5	16	12	30
H8050510-12-06	3/4"-14	3/8"-19	41	16	12	32
H8050510-08-08	1/2"-14	1/2"-14	40,5	14	14	27
H8050510-10-08	5/8"-14	1/2"-14	42	16	14	30
H8050510-12-08	3/4"-14	1/2"-14	43,5	16	14	32
H8050510-16-08	1"-11	1/2"-14	47,5	19	14	41
H8050510-10-10	5/8"-14	5/8"-14	44,5	16	16	30
H8050510-12-10	3/4"-14	5/8"-14	45,5	16	16	32
H8050510-16-10	1"-11	5/8"-14	49,5	19	16	41
H8050510-12-12	3/4"-14	3/4"-14	45,5	16	16	32
H8050510-16-12	1"-11	3/4"-14	49,5	19	16	41
H8050510-20-12	1-1/4"-11	3/4"-14	53,5	20	16	50
H8050510-16-16	1"-11	1"-11	52,5	19	19	41
H8050510-20-16	1-1/4"-11	1"-11	56,5	20	19	50
H8050510-24-16	1-1/2"-11	1"-11	58,5	22	19	55
H8050510-20-20	1-1/4"-11	1-1/4"-11	57,5	20	20	50
H8050510-24-20	1-1/2"-11	1-1/4"-11	59,5	22	20	55
H8050510-32-20	2"-11	1-1/4"-11	63	25	20	70
H8050510-24-24	1-1/2"-11	1-1/2"-11	61,5	22	22	55
H8050510-32-24	2"-11	1-1/2"-11	65	22	22	70
H8050510-32-32	2"-11	2"-11	68,5	22	25	70

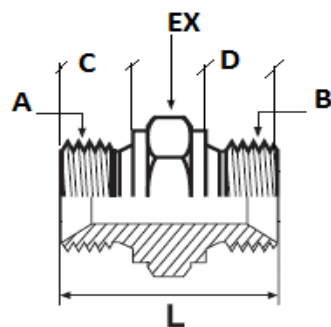

Union Doble Macho Cilíndrica-Cónica BPS

REFERENCIA	ROSCA A	ROSCA B	LONGITUD	A	EX
H8050710-02-02	1/8"-28	1/8"-28	26	10	12
H8050710-04-02	1/4"-19	1/8"-28	31	11	17
H8050710-04-04	1/4"-19	1/4"-19	32	11	17
H8050710-04-06	1/4"-19	3/8"-19	33,5	11	19
H8050710-06-04	3/8"-19	1/4"-19	35,5	13	19
H8050710-06-06	3/8"-19	3/8"-19	35,5	13	19
H8050710-06-08	3/8"-19	1/2"-14	39	13	24
H8050710-08-06	1/2"-14	3/8"-19	37	14	24
H8050510-08-08	1/2"-14	1/2"-14	40	14	24
H8050710-10-08	5/8"-14	1/2"-14	41	16	30
H8050710-10-10	5/8"-14	5/8"-14	43	16	30
H8050710-10-12	5/8"-14	3/4"-14	43	16	32
H8050710-12-08	3/4"-14	1/2"-14	43	17	32
H8050710-12-12	3/4"-14	3/4"-14	45	17	32
H8050710-12-16	3/4"-14	1"-11	49	17	41
H8050710-16-12	1"-11	3/4"-14	50	20	41
H8050510-16-16	1"-11	1"-11	52	20	41
H8050710-16-20	1"-11	1-1/4"-11	53	20	46
H8050710-20-16	1-1/4"-11	1"-11	54	21	46
H8050710-20-20	1-1/4"-11	1-1/4"-11	55	21	46
H8050710-24-24	1-1/2"-11	1-1/2"-11	58	22	55
H850710-32-32	2"-11	2"-11	66	25	65

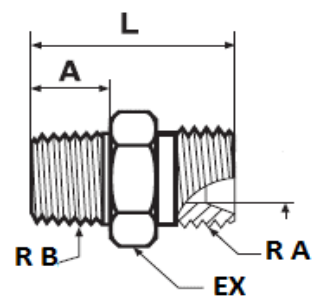

Union Macho Hembra Giratoria BPS

REFERENCIA	ROSCA A	ROSCA B	LONGITUD	A	EX	EX 1
H9050511-04-04	1/4"-19	1/4"-19	36	11	19	19
H9050511-04-06	1/4"-19	3/8"-19	40	11	22	22
H9050511-06-04	3/8"-19	1/4"-19	38	13	22	19
H9050511-06-06	3/8"-19	3/8"-19	41	13	22	22
H9050511-06-08	3/8"-19	1/2"-14	43	13	27	27
H9050511-08-06	1/2"-14	3/8"-19	44	14	27	22
H9050511-08-08	1/2"-14	1/2"-14	46	14	27	27
H9050511-08-12	1/2"-14	3/4"-14	49	14	32	27
H9050511-12-08	3/4"-14	1/2"-14	49	17	32	27
H9050511-12-12	3/4"-14	3/4"-14	52	17	32	32
H9050511-12-16	3/4"-14	1"-11	56	17	38	41
H9050511-16-12	1"-11	3/4"-14	56	20	41	32
H9050511-16-16	1"-11	1"-11	60	20	41	41
H9050511-16-20	1"-11	1-1/4"-11	58	20	50	50
H9050512-20-16	1-1/4"-11	1"-11	50	21	50	41
H9050512-20-20	1-1/4"-11	1-1/4"-11	69	21	50	50
H9050512-20-24	1-1/4"-11	1-1/2"-11	61	21	55	55
H9050512-24-20	1-1/2"-11	1-1/4"-11	60	22	55	50
H9050512-24-24	1-1/2"-11	1-1/2"-11	74	22	55	55
H9050512-24-32	1-1/2"-11	2"-11	69	22	70	70
H9050512-32-24	2"-11	1-1/2"-11	65	25	70	55
H9050512-32-32	2"-11	2"-11	79	25	70	70

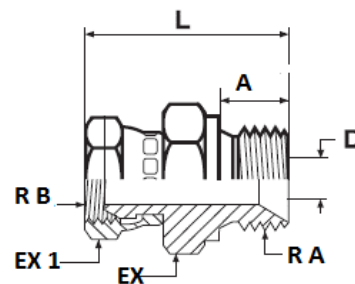

Adaptador Doble Hembra BPS

REFERENCIA	ROSCA	LONGITUD	L1	EX
H7050511-04-04	1/4"-19	36	31	19
H7050511-06-06	3/8"-19	42	35	22
H7050511-08-08	1/2"-14	48	39	27
H7050511-12-12	3/4"-14	54	42	32
H7050511-16-16	1"-11	59	47	41
H7050511-20-20	1-1/4"-11	69	57	50

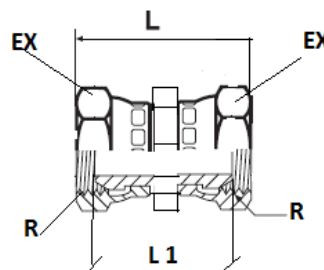

Esférico Roscado

REFERENCIA	ROSCA	LONGITUD	L1	EX
1401-04-04	1/4"-19	1/4"-19	24	14,5
1401-06-04	3/8"-19	1/4"-19	27	17
1401-06-06	3/8"-19	3/8"-19	27	17
1401-08-06	1/2"-14	3/8"-19	32	23,5
1401-08-08	1/2"-14	1/2"-14	32	23,5
1401-12-08	3/4"-14	1/2"-14	38	28
1401-12-12	3/4"-14	3/4"-14	38	28
1401-16-16	1"-11	1"-11	46	38

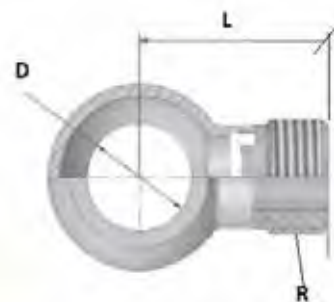

Esférico Soldable

REFERENCIA	DIÁMETRO	DIAM. A	LONGITUD
1400-02-02	1/8"-28	8	20
1400-04-04	1/4"-19	10	25
1400-06-06	3/8"-19	12	27
1400-08-08	1/2"-14	15	32
1400-12-12	3/4"-14	20	40
1400-16-16	1"-11	22	42

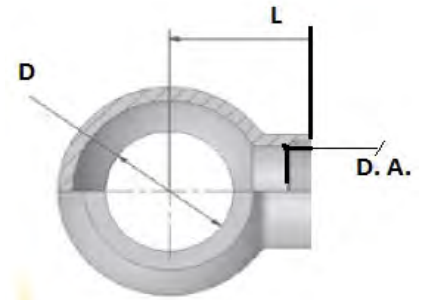

Tornillo Hueco BSP

REFERENCIA	ROSCA	A	L	EX
H2400-02-02	1/8"-28	25	21	14
H2400-04-04	1/4"-19	35	26	19
H2400-06-06	3/8"-19	38	33	22
H2400-08-08	1/2"-14	48	38	27
H2400-10-10	5/8"-14	53	44	30
H2400-12-12	3/4"-14	57	46	32
H2400-16-16	1"-11	69	59	41

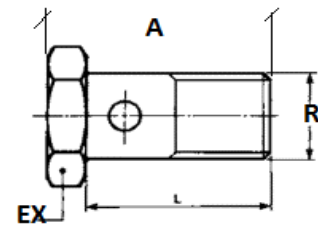

Tornillo Hueco Doble BSP

REFERENCIA	ROSCA	A	L	EX
H2402-02-02	1/8"-28	36	31	14
H2402-04-04	1/4"-19	40	43	19
H2402-06-06	3/8"-19	57	49	22
H2402-08-08	1/2"-14	73	64	27
H2402-10-10	5/8"-14	79	70	30
H2402-12-12	3/4"-14	86	76	32
H2402-16-16	1"-11	109	98	41

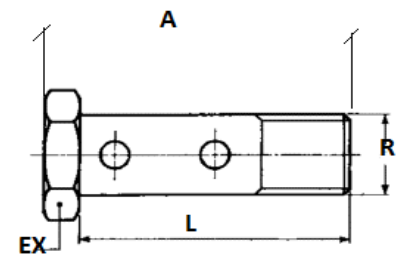

Tornillo Hueco Prolongado BSP

REFERENCIA	ROSCA	A	B	C	EX
H2401-04-04	1/4"-19	44	11	26	19
H2401-06-06	3/8"-19	53	12	33	22
H2401-08-08	1/2"-14	63	14	38	27
H2401-12-12	3/4"-14	72	16	46	32
H2401-16-16	1"-11	89	19	59	41

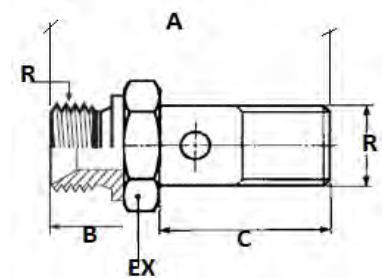

Tornillo Hueco Prolongado Reductor BSP

REFERENCIA	ROSCA A	ROSCA B	A	B	C	EX
H2410-04-06	1/4"-19	3/8"-19	44	11	26	22
H2410-06-08	3/8"-19	1/2"-14	54	12	33	27
H2410-08-12	1/2"-14	3/4"-14	62	14	38	32
H2410-12-16	3/4"-14	1"-11	73	16	46	41

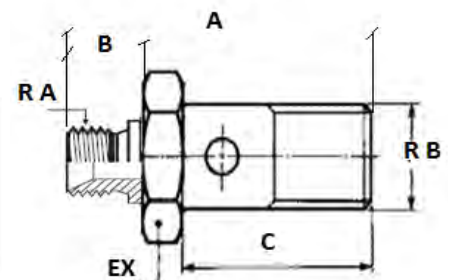

Reductor Macho Hembra Fijo BSP

REFERENCIA	ROSCA A	ROSCA B	LONGITUD	EX
H2227-04-02	1/4"-19	1/8"-28	18	19
H2227-06-02	3/8"-19	1/8"-28	21	22
H2227-06-04	3/8"-19	1/4"-19	21	22
H2227-08-04	1/2"-14	1/4"-19	24	27
H2227-08-06	1/2"-14	3/8"-19	24	27
H2227-12-04	3/4"-14	1/4"-19	26	32
H2227-12-06	3/4"-14	3/8"-19	26	32
H2227-12-08	3/4"-14	1/2"-14	26	32
H2227-16-04	1"-11	1/4"-19	29	41
H2227-16-06	1"-11	3/8"-19	29	41
H2227-16-08	1"-11	1/2"-14	29	41
H2227-16-12	1"-11	3/4"-14	29	41
H2227-20-08	1-1/4"-11	1/2"-14	32	50
H2227-20-12	1-1/4"-11	3/4"-14	32	50
H2227-20-16	1-1/4"-11	1"-11	32	50
H2227-24-08	1-1/2"-11	1/2"-14	35	55
H2227-24-12	1-1/2"-11	3/4"-14	35	55
H2227-24-16	1-1/2"-11	1"-11	35	55
H2227-24-20	1-1/2"-11	1-1/4"-11	35	55
H2227-32-16	2"-11	1"-11	36	70
H2227-32-20	2"-11	1-1/4"-11	36	70
H2227-32-24	2"-11	1-1/2"-11	36	70

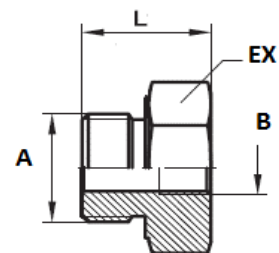

Reductor Macho Hembra Fijo BSP

REFERENCIA	A	B	L	EX
H2226-04-02	1/4"-19	1/8"-28	27,5	19
H2226-06-02	3/8"-19	1/8"-28	32	22
H2226-06-04	3/8"-19	1/4"-19	33	22
H2226-08-04	1/2"-14	1/4"-19	35	27
H2226-08-06	1/2"-14	3/8"-19	37	27
H2226-12-04	3/4"-14	1/4"-19	39	32
H2226-12-06	3/4"-14	3/8"-19	41	32
H2226-12-08	3/4"-14	1/2"-14	42	32
H2226-16-08	1"-11	1/2"-14	44	41
H2226-16-12	1"-11	3/4"-14	47	41
H2226-20-12	1-1/4"-11	3/4"-14	49	50
H2226-20-16	1-1/4"-11	1"-11	51	50
H2226-24-16	1-1/2"-11	1"-11	53	55
H2226-24-20	1-1/2"-11	1-1/4"-11	55	55

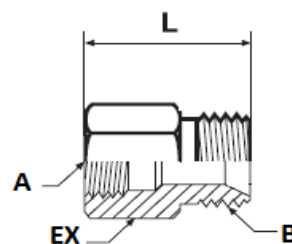

Prolongado Macho Hembra Fijo BSP

REFERENCIA	ROCA	L	EX
H2222-02-02	1/8"-28	27	17
H2222-04-04	1/4"-19	30	19
H2222-06-06	3/8"-19	34	22
H2222-08-08	1/2"-14	36	27
H2222-12-12	3/4"-14	42	32
H2222-16-16	1"-11	49	41
H2222-20-20	1-1/4"-11	53	50
H2222-24-24	1-1/2"-11	57	55
H2222-32-32	2"-11	65	70

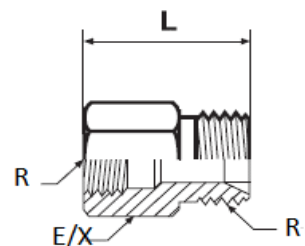

Tapón Macho BSP

REFERENCIA	ROSCA	L	EX
H4050010-02	1/8"-28	13,5	14
H4050010-04	1/4"-19	18	19
H4050010-06	3/8"-19	21	22
H4050010-08	1/2"-14	24	27
H4050010-10	5/8"-14	24	30
H4050010-12	3/4"-14	26	32
H4050010-16	1"-11	29	41
H4050010-20	1-1/4"-11	32	50
H4050010-24	1-1/2"-11	35	55
H4050010-32	2"-11	36	70

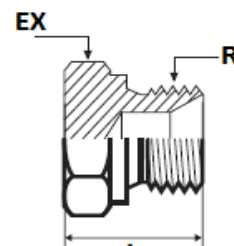

Tapón Hembra BSP

REFERENCIA	ROSCA	L	EX
H2501-02-02	1/8"-28	15	14
H2501-04-04	1/4"-19	19	17
H2501-06-06	3/8"-19	23	22
H2501-08-08	1/2"-14	27	27
H2501-10-10	5/8"-14	30	30
H2501-12-12	3/4"-14	31	32
H2501-16-16	1"-11	36	41
H2501-20-20	1-1/4"-11	42	50
H2501-24-24	1-1/2"-11	48	55
H2501-32-32	2"-11	54	70

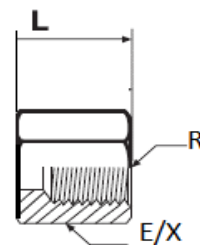

Macho Soldable con Hexágono BSP

REFERENCIA	ROSCA	L	B	EX
H2011-04-04	1/4"-19	18	10	19
H2011-06-06	3/8"-19	21	12	22
H2011-08-08	1/2"-14	24	15	27
H2011-12-12	3/4"-14	26	20	32
H2011-16-16	1"-11	29	25	41
H2011-20-20	1-1/4"-11	32	30	50
H2011-24-24	1-1/2"-11	35	35	55
H2011-32-32	2"-11	40	42	70

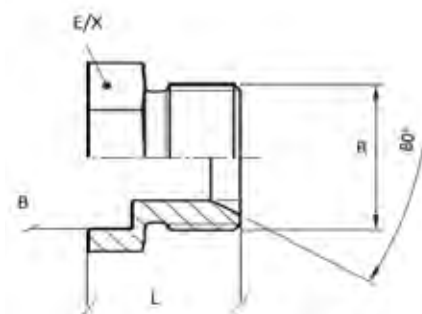

Empalme Soldar Rosca Hembra BSP

REFERENCIA	ROSCA	DIÁMETRO	L
H1521-02-02	1/8"-28	18	13
H1521-04-04	1/4"-19	22	16
H1521-06-06	3/8"-19	26	17
H1521-08-08	1/2"-14	30	18
H1521-10-10	5/8"-14	34	20
H1521-12-12	3/4"-14	38	20
H1521-16-16	1"-11	45	25
H1521-20-20	1-1/4"-11	55	25
H1521-24-24	1-1/2"-11	60	30
H1521-32-32	2"-11	75	30

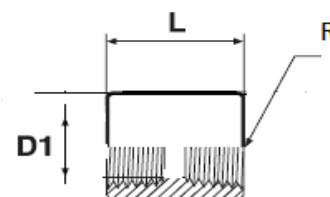

Cono de Ajuste BSP

REFERENCIA	TIPO	A	B	C	D	E
H1500-04-04	1/4"	28	5	21	11,2	9
H1500-06-06	3/8"	29	5	22	14,7	12
H1500-08-08	1/2"	30	5	23	18,5	16
H1500-12-12	3/4"	32	5	25	24	20
H1500-16-16	1"	34	5	27	30	26
H1500-20-20	1-1/4"	39	7,5	29	39	33
H1500-24-24	1-1/2"	34	8	32	45	40
H1500-32-32	2"	48	9	36	56,5	50

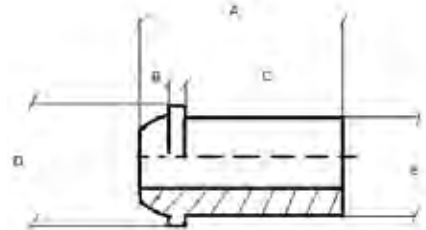

Empalme Soldable Cilíndrico BSP

REFERENCIA	ROSCA	A	B
H1501-02-02	1/8"-28	18	8
H1501-04-04	1/4"-19	21	10
H1501-06-06	3/8"-19	25	12
H1501-08-08	1/2"-14	27	14
H1501-12-12	3/4"-14	31	16
H1501-16-16	1"-11	33	18
H1501-20-20	1-1/4"-11	34	19
H1501-24-24	1-1/2"-11	35	20
H1501-32-32	2"-11	38	23

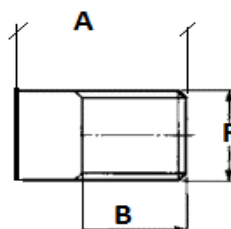

Empalme Soldable Exagonal BSP

REFERENCIA	ROSCA	A	B	D	EX
H2600-02-02	1/8"-28	20	4	10	11
H2600-04-04	1/4"-19	26	5	14	15
H2600-06-06	3/8"-19	30	6	16	18
H2600-08-08	1/2"-14	35	8	20	22
H2600-12-12	3/4"-14	40	10	25	27
H2600-16-16	1"-11	45	12	32	35
H2600-20-20	1-1/4"-11	49	14	41	45
H2600-24-24	1-1/2"-11	53	16	46	50
H2600-32-32	2"-11	59	18	58	60

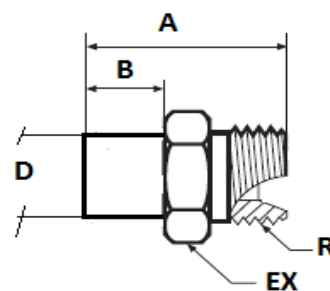

Pasatabique BSP

REFERENCIA	ROSCA	L	B	EX
H2224-04-04	1/4"-19	46	28	19
H2400-06-06	3/8"-19	52	32	22
H2400-08-08	1/2"-14	59	35	27
H2400-12-12	3/4"-14	66	38	32
H2400-16-16	1"-11	75	41	41
H2400-20-20	1-1/4"-11	83	44	50
H2400-24-24	1-1/2"-11	93	48	55

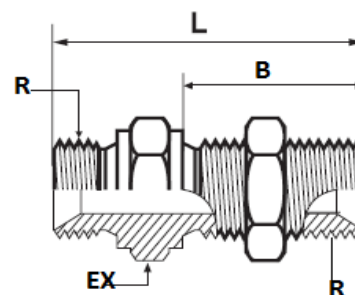

Codo 90° Macho Orientable BSP

REFERENCIA	ROSCA	A	B	H
H9026-04-04	1/4"-19	27	32	14
H9026-06-06	3/8"-19	31	37	19
H9026-08-08	1/2"-14	36	43	22
H9026-12-12	3/4"-14	40	49	27
H9026-16-16	1"-11	50	52	33
H9026-20-20	1-1/4"-11	52	57	41

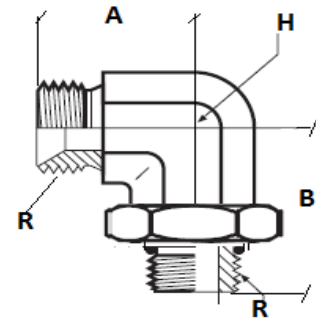

Tuerca Pasatabique BSO

REFERENCIA	ROSCA	A	EX
H2225-02-02	1/8"-28	6	14
H2225-04-04	1/4"-19	7	19
H2225-06-06	3/8"-19	8	22
H2225-08-08	1/4"-14	9	27
H2225-12-12	3/4"-14	12	32
H2225-16-16	1"-11	12	41
H2228-20-20	1-1/4"-11	12	50
H2225-24-24	1-1/2"-11	12	55

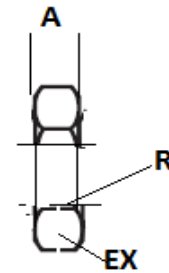

Juntas Metal-Buna BSP

REFERENCIA	A	L	ANCHO
H2301-02-02	1/8"	18	2,5
H2301-04-04	1/4"	21	2,5
H2301-06-06	3/8"	24	2,5
H2301-08-08	1/2"	29	2,5
H2301-12-12	3/4"	35	2,5
H2301-16-16	1"	43	3,5
H2301-20-20	1-1/4"	52	3,5
H2301-24-24	1-1/2"	58	3,5
H2301-32-32	2"	73	3,5

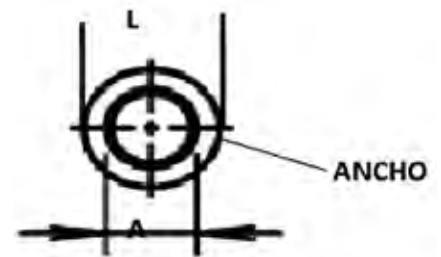

Codo 90° Accesorial Macho-Hembra Giratorio BSP

REFERENCIA	ROSCA	A	B	EX
H9050591-04-04	1/4"-19	34	33	19
H9050591-06-06	3/8"-19	44	40	22
H9050591-08-08	1/2"-14	47	44	27
H9050591-12-12	3/4"-14	59	57	32
H9050591-16-16	1"-11	68	69	41
H9050591-20-20	1-1/4"-11	77	76	50
H9050591-24-24	1-1/2"-11	97	95	55
H9050591-32-32	2"-11	118	114	70

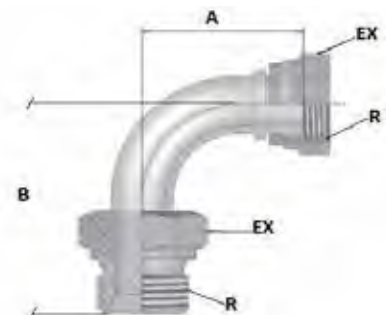

Codo 90° Accesorial Macho-Hembra Giratorio BSP

REFERENCIA	ROSCA	A	EX
H7050591-04-04	1/4"-19	34	19
H7050591-06-06	3/8"-19	44	22
H7050591-08-08	1/2"-14	47	27
H7050591-12-12	3/4"-14	59	32
H7050591-16-16	1"-11	68	41
H7050591-20-20	1-1/4"-11	77	50
H7050591-24-24	1-1/2"-11	97	55
H7050591-32-32	2"-11	118	70

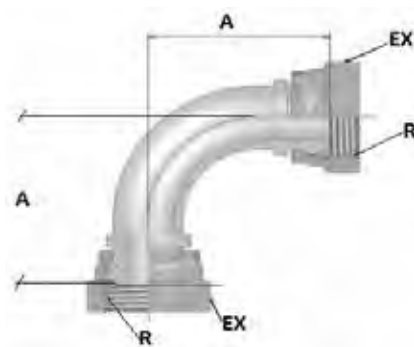

Codo 45° Accesorial Macho-Hembra BSP

REFERENCIA	ROSCA	A	B	EX
H9050541-04-04	1/4"-19	20	46	19
H9050541-06-06	3/8"-19	23	54	22
H9050541-08-08	1/2"-14	25	56	27
H9050541-12-12	3/4"-14	30	72	32
H9050541-16-16	1"-11	34	82	41
H9050541-20-20	1-1/4"-11	40	93	50
H9050541-24-24	1-1/2"-11	48	116	55

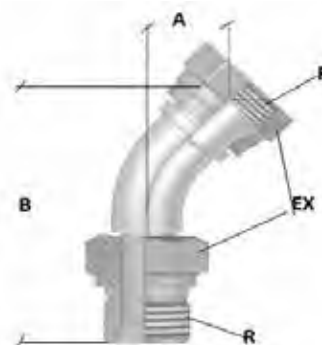

Codo 90° Macho Cilíndrico/Cónico BSP/BSPT

REFERENCIA	ROSCA 1	ROSCA 2	A	H
H9036-02-02	1/8"-28	1/8"-28	20	12
H9036-04-04	1/4"-19	1/4"-19	28	14
H9036-06-06	3/8"-19	3/8"-19	30	19
H9036-08-08	1/2"-14	1/2"-14	37	22
H9036-12-12	3/4"-14	3/4"-14	40	27
H9036-16-16	1"-11	1"-11	50	33
H9036-20-20	1-1/4"-11	1-1/4"-11	52	41

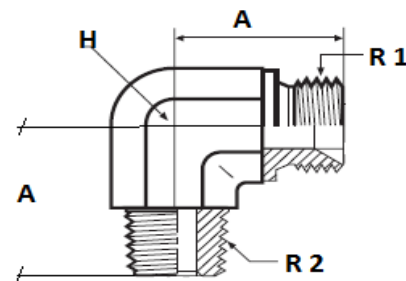

Codo 90° Macho Cilíndrico BSP

REFERENCIA	ROSCA	A	H
H9022-02-02	1/8"-28	20	12
H9022-04-04	1/4"-19	28	14
H9022-06-06	3/8"-19	30	19
H9022-08-08	1/2"-14	37	22
H9022-12-12	3/4"-14	40	27
H9022-16-16	1"-11	50	33
H9022-20-20	1-1/4"-11	52	41

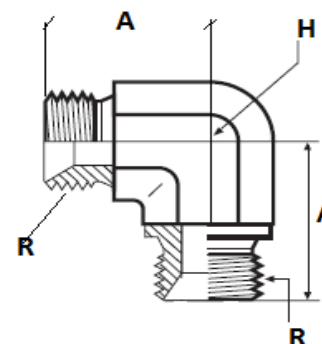

Codo 90° Macho Cilíndrico Reductor BSP

REFERENCIA	ROSCA 1	ROSCA 2	A	H
H9025-02-04	1/4"-19	1/8"-28	27	14
H9025-04-06	3/8"-19	1/4"-19	30	19
H9025-06-08	1/2"-14	3/8"-19	37	22
H9025-08-12	3/4"-14	1/2"-14	40	27
H9025-12-16	1"-11	3/4"-14	48	33
H9025-16-20	1-1/4"-11	1"-11	52	41
H9025-20-24	1-1/2"-11	1-1/4"-11	59	48
H9025-24-32	2"-11	1-1/2"-11	65	65

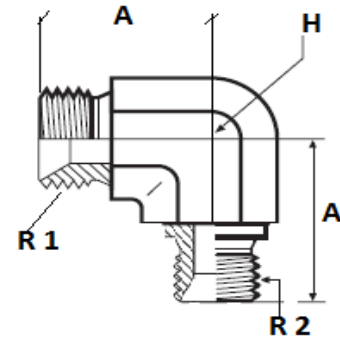

Codo 90° Pasatabique BSP

REFERENCIA	ROSCA	A	B	EX
H9037-04-04	1-4"-19	45	25	14
H9037-06-06	3/8"-19	52	30	19
H9037-08-08	1/2"-14	50	35	22
H9037-12-12	3/4"-14	65	40	27
H9037-16-16	1"-11	71	45	33
H9037-20-20	1-1/4"-11	80	51	41
H9037-24-24	1-1/2"-11	92	54	48

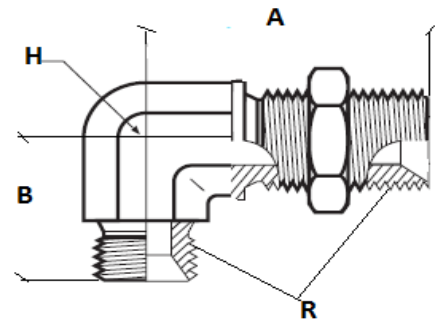

Codo 90° Macho-Hembra Giratoria BSP

REFERENCIA	ROSCA	A	B	H	EX
H9033-04-04	1/4"-19	29	27	14	19
H9033-06-06	3/8"-19	34	31	19	22
H9033-08-08	1/2"-14	40	36	22	27
H9033-12-12	3/4"-14	45	40	27	32
H9033-16-16	1"-11	51	50	33	41
H9033-20-20	1-1/4"-11	54	52	41	50

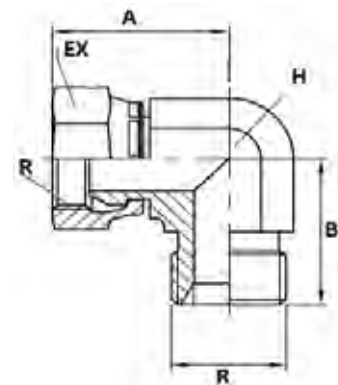

Codo 45° Macho-Hembra BSP

REFERENCIA	ROSCA	A	B	H	EX
H9028-02-02	1/8"-28	24	24	11	14
H9028-04-04	1/4"-19	26	26	14	19
H9028-06-06	3/8"-19	34	34	19	22
H9028-08-08	1/2"-14	36	36	22	27
H9028-12-12	3/4"-14	39	39	27	32
H9028-16-16	1"-11	41	41	33	41
H9028-20-20	1-1/4"-11			41	50
H9028-24-24	1-1/2"-11			48	55

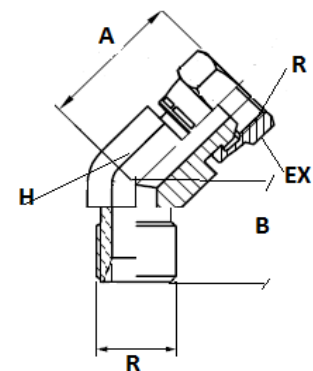

Codo 90° Hembra Fija BSP

REFERENCIA	ROSCA	A	H
H9301-02-02	1/8"-28	17	14
H9301-04-04	1/4"-19	22	17
H9301-06-06	3/8"-19	26	22
H9301-08-08	1/2"-14	31	27
H9301-12-12	3/4"-14	35	32
H9301-16-16	1"-11	44	41
H9301-20-20	1-1/4"-11	50	48

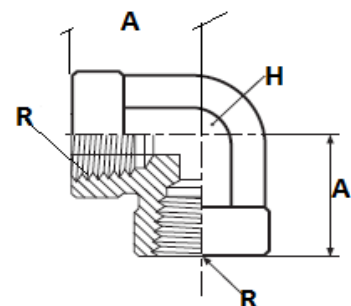

T Hembra Fija BSP

REFERENCIA	ROSCA	A	B	H
H9300-02-02	1/8"-28	34	17	14
H9030-04-04	1/4"-19	44	22	17
H9030-06-06	3/8"-19	52	26	22
H9030-08-08	1/2"-14	62	31	27
H9030-12-12	3/4"-14	70	35	32
H9030-16-16	1"-11	88	44	41
H9030-20-20	1-1/4"-11	100	50	48

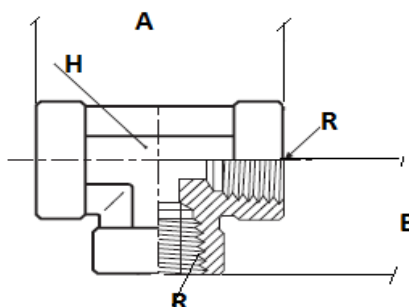

T Macho BSP

REFERENCIA	ROSCA	A	B	H
H9800-02-02	1/8"-28	40	20	12
H9800-04-04	1/4"-19	54	27	14
H9800-06-06	3/8"-19	60	30	19
H9800-08-08	1/2"-14	74	37	22
H9800-10-10	5/8"-14	80	40	24
H9800-12-12	3/4"-14	80	40	27
H9800-16-16	1"-11	100	50	33
H9800-20-20	1-1/4"-11	104	52	41

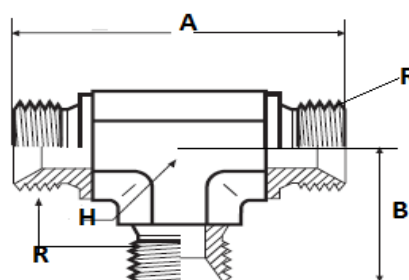

T Macho Reductor BSP

REFERENCIA	ROSCA 1	ROSCA 2	A	B	H
H9801-02-04	1/4"-19	1/8"-28	54	27	14
H9801-04-06	3/8"-19	1/4"-19	60	30	19
H9801-06-08	1/2"-14	3/8"-19	74	37	22
H9801-08-12	3/4"-14	1/2"-14	80	40	27
H9801-12-16	1"-11	3/4"-14	96	48	33
H9801-16-20	1-1/4"-11	1"-11	104	52	41
H9801-20-24	1-1/2"-11	1-1/4"-11	118	59	48

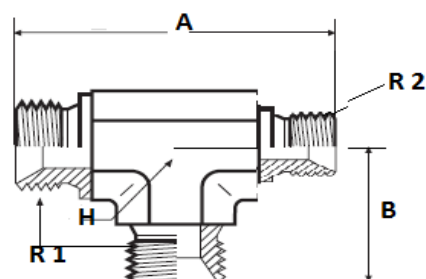

T Macho-Macho-Hembra Lateral BSP

REFERENCIA	ROSCA 1	A	B	H	EX
H9833-04-04	1-4"-19	56	27	14	19
H9833-06-06	3/8"-19	65	32	19	22
H9833-08-08	1/2"-14	76	36	22	27
H9833-12-12	3/4"-14	86	40	27	32
H9833-16-16	1"-11	102	50	33	41
H9833-20-20	1-1/4"-11	106	52	41	50

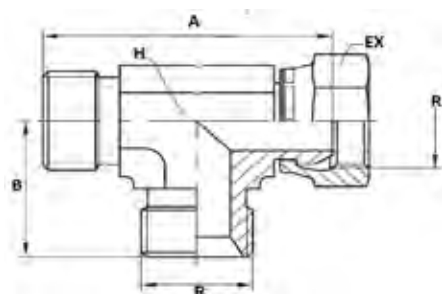

T Macho-Macho-Hembra Central BSP

REFERENCIA	ROSCA	A	B	H	EX
H9834-04-04	1/4"-19	54	29	14	19
H9834-06-06	3/8"-19	63	34	19	22
H9834-08-08	1/2"-14	72	40	22	27
H9834-12-12	3/4"-14	80	46	27	32
H9834-16-16	1"-11	100	52	33	41
H9834-20-20	1-1/4"-11	104	54	41	50

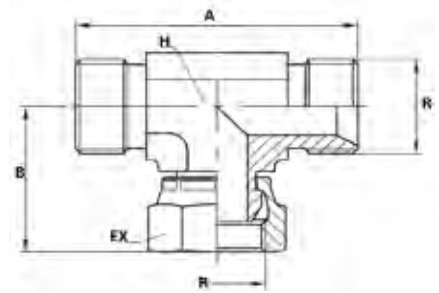

Cruz Macho BSP

REFERENCIA	ROSCA	A	B	H
H9835-02-02	1/8"-28	40	20	12
H9835-04-04	1/4"-19	54	27	14
H9835-06-06	3/8"-19	60	30	19
H9835-08-08	1/2"-14	70	35	22
H9835-12-12	3/4"-14	80	40	27
H9835-16-16	1"-11	100	50	33

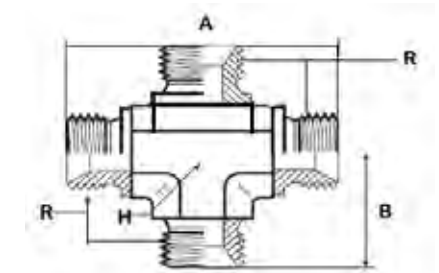

Tuerca JIC

REFERENCIA	ROSCA	L	EX
72500-04-04	7/16"-20	15,5	14
72500-05-05	1/2"-20	17	17
72500-06-06	9/16"-18	18,5	19
72500-08-08	3/4"-16	21,5	22
72500-10-10	7/8"-14	24,5	27
72500-12-12	1-1/16"-12	26	32
72500-16-16	1-5/16"-12	28,5	41
72500-20-20	1-5/8"-12	31	50
72500-24-24	1-7/8"-12	36	60

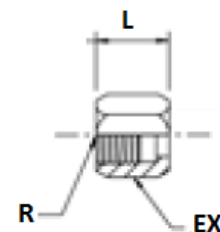

Férula para Tubo Métrico

REFERENCIA	L	T
72503-00-06	10,5	6
72503-00-08	11,5	8
72503-00-10	12,5	10
72503-00-12	14,5	12
72503-00-14	16,5	14
72503-00-15	16,5	15
72503-00-16	16,5	16
72503-00-18	17	18
72503-00-20	17	20
72503-00-25	19,5	25
72503-00-28	20,5	28
72503-00-30	23	30
72503-00-35	23	35
72503-00-38	28,5	38

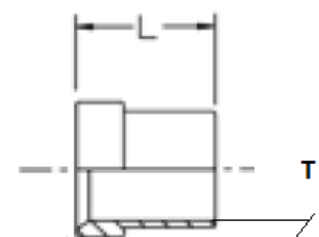

Unión Macho Doble JIC 37°

REFERENCIA	ROSCA	A	EX
H8252510-04-04	7/16"-20	34,5	14
H8252510-05-05	1/2"-20	34,5	14
H8252510-06-06	9/16"-18	35,5	17
H8252510-08-08	3/4"-16	41	19
H8252510-10-10	7/8"-14	47,5	24
H8252510-12-12	1-1/16"-12	55	30
H8252510-16-16	1-5/16"-12	57	36
H8252510-20-20	1-5/8"-12	61,5	46
H8252510-24-24	1-7/8"-12	69,5	50

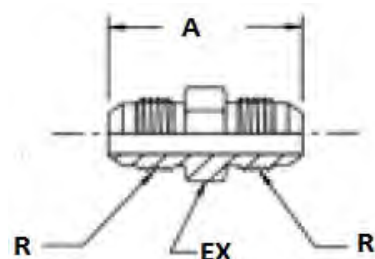

Unión Doble Macho BSP-JIC

REFERENCIA	ROSCA 1	ROSCA 2	A	EX
H8052510-02-04	7/16"-20	1/8"-28	29	17
H8052510-04-04	7/16"-20	1/4"-19	34,5	19
H8052510-06-04	7/16"-20	3/8"-19	34,5	22
H8052510-08-04	7/16"-20	1/2"-14	38	30
H8052510-04-05	1/2"-20	1/4"-19	34,5	19
H8052510-06-05	1/2"-20	3/8"-19	34,5	22
H8052510-04-06	9/16"-18	1/4"-19	34,5	19
H8052510-06-06	9/16"-18	3/8"-19	34,5	22
H8052510-08-06	9/16"-18	1/2"-14	38	30
H8052510-04-08	3/4"-16	1/4"-19	37,5	22
H8052510-06-08	3/4"-16	3/8"-19	37,5	22
H8052510-08-08	3/4"-16	1/2"-14	41	30
H8052510-12-08	3/4"-16	3/4"-14	45	36
H8052510-06-10	7/8"-14	3/8"-19	40,5	24
H8052510-08-10	7/8"-14	1/2"-14	43,5	30
H8052510-08-12	1-1/16"-12	1/2"-14	47	30
H8052510-12-16	1-5/16"-12	3/4"-14	50	36
H8052510-16-20	1-5/8"-12	1"-11	52,5	46
H8052510-12-20	1-5/8"-12	3/4"-14	50	36
H8052510-16-20	1-5/8"-12	1"-11	52,5	46
H8052510-12-24	1-7/8"-12	3/4"-14	51	36
H8052510-16-24	1-7/8"-12	1"-11	53,5	46
H8052510-20-20	1-5/8"-12	1-1/4"-11	57	50
H8052510-24-20	1-5/8"-12	1-1/2"-11	58,5	50
H8052510-20-24	1-7/8"-12	1-1/4"-11	61,5	50
H8052510-24-24	1-7/8"-12	1-1/2"-11	65,5	60

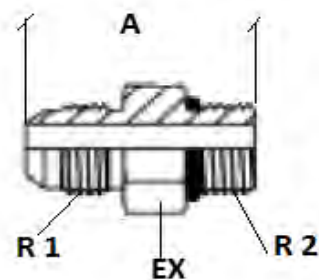

Unión Doble Macho JIC-SAE

REFERENCIA	ROSCA 1	ROSCA 2	A	EX
H8253010-04-04	7/16"-20	7/16"-20	31	14
H8253010-04-05	7/16"-20	1/2"-20	31	14
H8253010-04-06	7/16"-20	9/16"-18	33	17
H8253010-05-05	1/2"-20	1/2"-20	31	14
H8253010-06-06	9/16"-18	9/16"-18	33	17
H8253010-06-08	9/16"-18	3/4"-16	34,5	19
H8253010-08-08	3/4"-16	3/4"-16	37,5	19
H8253010-08-10	3/4"-16	7/8"-14	40,5	24
H8253010-08-12	3/4"-16	1-1/16"-12	45	30
H8253010-10-08	7/8"-14	3/4"-16	40,5	24
H8253010-10-10	7/8"-14	7/8"-14	43	24
H8253010-10-12	7/8"-14	1-1/16"-12	47,5	30
H8253010-12-08	1-1/16"-12	3/4"-16	45	30
H8253010-12-10	1-1/16"-12	7/8"-14	46,5	30
H8253010-12-12	1-1/16"-12	1-1/16"-12	50	30
H8253010-12-16	1-1/16"-12	1-5/16"-12	51	36
H8253010-16-12	1-5/16"-12	1-1/16"-12	51	36
H8253010-16-16	1-5/16"-12	1-5/16"-12	52	36
H8253010-16-20	1-5/16"-12	1-5/8"-12	53,5	46
H8253010-20-20	1-5/8"-12	1-5/8"-12	55	46
H8253010-24-24	1-7/8"-12	1-7/8"-12	60	50

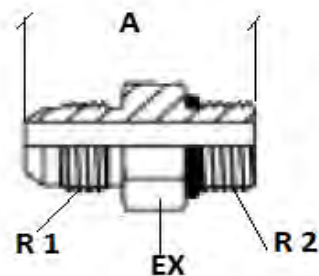

Unión Doble Macho JIC-BSPT

REFERENCIA	ROSCA 1	ROSCA 2	A	EX
H8250710-04-02	7/16"-20	1/8"-28	29	14
H8250710-04-04	7/16"-20	1/4"-19	33	14
H8250710-05-02	1/2"-20	1/8"-28	29	14
H8250710-05-04	1/2"-20	1/4"-19	33	14
H8250710-06-04	9/16"-18	1/4"-19	33,5	17
H8250710-06-06	9/16"-18	3/8"-19	33,5	17
H8250710-06-08	9/16"-18	1/2"-14	37,5	22
H8250710-08-04	3/4"-16	1/4"-19	36,5	22
H8250710-08-06	3/4"-16	3/8"-19	36,5	22
H8250710-08-08	3/4"-16	1/2"-14	40,5	22
H8250710-10-06	7/8"-14	3/8"-19	41	24
H8250710-10-08	7/8"-14	1/2"-14	43	24
H8250710-10-12	7/8"-14	3/4"-14	47	30
H8250710-12-08	1-1/16"-12	1/2"-14	47,5	30
H8250710-12-12	1-1/16"-12	3/4"-14	49,5	30
H8250710-12-16	1-1/16"-12	1"-11	51,5	36
H8250710-16-12	1-5/16"-12	3/4"-14	50,5	36
H8250710-16-16	1-5/16"-12	1"-11	52,5	36
H8250710-20-16	1-5/8"-12	1"-11	55,5	46
H8250710-20-20	1-5/8"-12	1-1/4"-11	57,5	46
H8250710-24-24	1-7/8"-12	1-1/2"-11	62,5	50

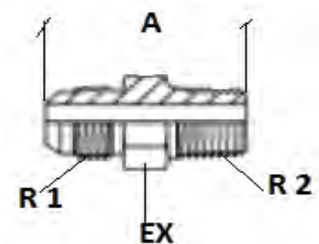

Unión Doble Macho JIC-NPTF

REFERENCIA	ROSCA 1	ROSCA 2	A	EX
H8252810-04-02	7/16"-20	1/8"-28	31	14
H8252810-04-04	7/16"-20	1/4"-18	35,5	14
H8252810-05-02	1/2"-20	1/8"-28	31	14
H8252810-05-04	1/2"-20	1/4"-18	35,5	14
H8252810-06-02	9/16"-18	1/8"-28	31,5	17
H8252810-06-04	9/16"-18	1/4"-18	36	17
H8252810-06-06	9/16"-18	3/8"-18	36	17
H8252810-06-08	9/16"-18	1/2"-14	42,5	22
H8252810-08-04	3/4"-16	1/4"-18	39	22
H8252810-08-06	3/4"-16	3/8"-18	39	22
H8252810-08-08	3/4"-16	1/2"-14	45,5	22
H8252810-08-12	3/4"-16	3/4"-14	47,5	30
H8252810-10-06	7/8"-14	3/8"-18	43,5	24
H8252810-10-08	7/8"-14	1/2"-14	48	24
H8252810-10-12	7/8"-14	3/4"-14	50	30
H8252810-12-08	1-1/16"-12	1/2"-14	52,5	30
H8252810-12-12	1-1/16"-12	3/4"-14	52,5	30
H8252810-12-16	1-1/16"-12	1"-11-1/2	57	36
H8252810-16-12	1-5/16"-12	3/4"-14	53,5	36
H8252810-16-16	1-5/16"-12	1"-11-1/2	58,5	33
H8252810-20-16	1-5/8"-12	1"-11-1/2	61,5	46
H8252810-20-20	1-5/8"-12	1-1/4"-11-1/2	62	46
H8252810-24-20	1-7/8"-12	1-1/4"-11-1/2	67	50
H8252810-24-24	1-7/8"-12	1-1/2"-11-1/2	68	50

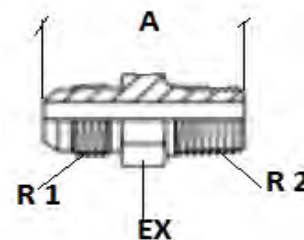

Unión Macho BSP Hembra Giratoria JIC

REFERENCIA	ROSCA 1	ROSCA 2	EX1	EX2
H9052511-04-02	7/16"-20	1/8"-28	17	17
H9052511-05-04	1/2"-20	1/4"-19	19	19
H9052511-06-04	9/16"-18	1/4"-19	19	19
H9052511-06-06	9/16"-18	3/8"-19	19	22
H9052511-08-06	3/4"-16	3/8"-19	24	22
H9052511-10-08	7/8"-14	1/2"-14	27	30
H9052511-12-12	1-1/16"-12	3/4"-14	32	36
H9052511-16-16	1-5/16"-12	1"-11	38	46
H9052511-20-20	1-5/8"-12	1-1/4"-11	50	50
H9052511-24-24	1-7/8"-12	1-1/2"-11	55	60

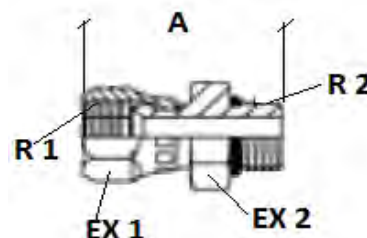

Codo 90° Macho JIC

REFERENCIA	ROSCA	A	H
79022-04-04	7/16"-20	22,5	14
79022-05-05	1/2"-20	24	14
79022-06-06	9/16"-18	27	14
79022-08-08	3/4"-14	31,5	19
79022-10-10	7/8"-14	36,5	22
79022-12-12	1-1/16"-12	42	27
79022-16-16	1-5/16"-12	46	33
79022-20-20	1-5/8"-12	52	41
79022-24-24	1-7/8"-12	59	48

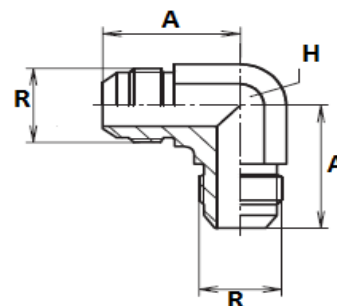

Codo 90° Macho JIC-NPTF

REFERENCIA	ROSCA 1	ROSCA 2	A	B	H
79225-04-02	7/16"-20	1/8"-27	22,5	19,5	14
79225-04-04	7/16"-20	1/4"-18	27	27,5	14
79225-05-02	1/2"-20	1/8"-27	24	19,5	14
79225-05-04	1/2"-20	1/4"-18	27	27,5	14
79225-06-04	9/16"-18	1/4"-18	27	27,5	14
79225-06-06	9/16"-18	3/8"-18	28,5	31	19
79225-06-08	9/16"-18	1/2"-14	31	37	22
79225-08-04	3/4"-16	1/4"-18	31,5	31	19
79225-08-06	3/4"-16	3/8"-18	31,5	31	19
79225-08-08	3/4"-16	1/2"-14	34	37	22
79225-10-06	7/8"-14	3/8"-18	36,5	32	22
79225-10-08	7/8"-14	1/2"-14	36,5	37	22
79225-10-12	7/8"-14	3/4"-14	39,5	40,5	27
79225-12-08	1-1/16"-12	1/2"-14	42	40,5	27
79225-12-12	1-1/16"-12	3/4"-14	42	40,5	27
79225-16-12	1-5/16"-12	3/4"-14	46	45	33
79225-16-16	1-5/16"-12	1"-11-1/2	46	50	33
79225-20-16	1-5/8"-12	1"-11-1/2	52	59	41
79225-20-20	1-5/8"-12	1-1/4"-11-1/2	52	60	41
79225-24-24	1-7/8"-12	1-1/2"-11-1/2	59	67	48

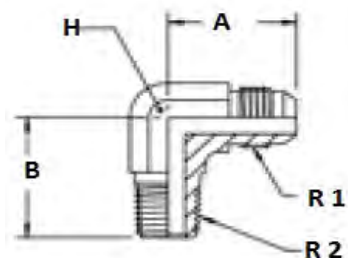

Codo 90° Macho JIC-BSPT

REFERENCIA	ROSCA 1	ROSCA 2	A	B	H
79226-04-02	7/6"-20	1/8"-28	22,5	19,5	14
79226-04-04	7/16"-20	1/4"-19	27	27,5	14
79226-05-02	1/2"-20	1/8"-28	24	19,5	14
79226-05-04	1/2"-20	1/4"-19	27	27,5	14
79226-06-04	9/16"-18	1/4"-19	27	27,5	14
79226-06-06	9/16"-18	3/8"-19	28,5	31	19
79226-06-08	9/16"-18	1/2"-14	31	37	22
79226-08-04	3/4"-16	1/4"-19	31,5	31	19
79226-08-06	3/4"-16	3/8"-19	31,5	31	19
79226-08-08	3/4"-16	1/2"-14	34	37	22
79226-10-06	7/8"-14	3/8"-19	36,5	32	22
79226-10-08	7/8"-14	1/2"-14	36,5	37	22
79226-10-12	7/8"-14	3/4"-14	39,5	40,5	27
79226-12-08	1-1/16"-12	1/2"-14	42	40,5	27
79226-12-12	1-1/16"-12	3/4"-14	42	40,5	27
79226-16-12	1-5/16"-12	3/4"-14	46	45	33
79226-16-16	1-5/16"-12	1"-11	46	50	33
79226-20-16	1-5/8"-12	1"-11	52	59	41
79226-24-24	1-7/8"-12	1-1/2"-11	59	67	48

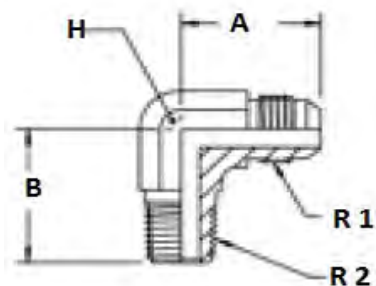

Codo 90° Macho Orientable Métrico-JIC

REFERENCIA	ROSCA 1	ROSCA 2	A	B	H
79027-04-02	7/16"-20	M-10X1	22,5	26	14
79027-05-03	1/2"-20	M-12X1,5	27	31,5	14
79027-06-04	9/16"-18	M-14X1,5	27	31,5	14
79027-08-05	3/4"-16	M-16X1,5	31,5	36,5	19
79027-08-06	3/4"-16	M-18X1,5	31,5	36,5	19
79027-10-06	7/8"-14	M-18X1,5	36,5	39,5	22
79027-10-08	7/8"-14	M-22X1,5	36,5	43	22
79027-12-08	1-1/16"-12	M-22X1,5	42	45,5	27
79027-12-14	1-1/16"-12	M-27X2	42	49	27
79027-16-16	1-5/16"-12	M-33X2	46	52	33
79027-20-20	1-5/8"-12	M-42X2	52	57	41
79027-24-24	1-7/8"-12	M-48X2	59	61	48

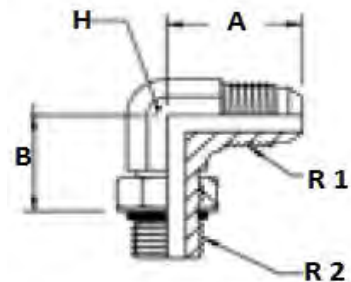

Codo 90° Macho Orientable BSP-JIC

REFERENCIA	ROSCA 1	ROSCA 2	A	B	H
79025-02-04	7/16"-20	1/8"-28	22,5	26	14
79025-04-04	7/16"-20	1/4"-19	27	31,5	14
79025-02-05	1/2"-20	1/8"-28	24	27,5	14
79025-04-05	1/2"-20	1/4"-19	27	31,5	14
79025-04-06	9/16"-18	1/4"-19	27	31,5	14
79025-06-06	9/16"-18	3/8"-19	28,5	36,5	19
79025-04-08	3/4"-16	1/4"-19	31,5	33,5	19
79025-06-08	3/4"-16	3/8"-19	31,5	36,5	19
79025-08-08	3/4"-16	1/2"-14	34	43	22
79025-08-10	7/8"-14	1/2"-14	36,5	43	22
79025-08-12	1-1/16"-12	1/2"-14	42	45,5	27
79025-12-12	1-1/16"-12	3/4"-14	42	49	27
79025-12-16	1-5/16"-12	3/4"-14	46	52	33
79025-16-16	1-5/16"-12	1"-11	46	52	33
79025-16-20	1-5/8"-12	1"-11	52	57	41
79025-20-20	1-5/8"-12	1-1/4"-11	52	57	41
79025-24-24	1-7/8"-12	1-1/2"-11	59	61	48

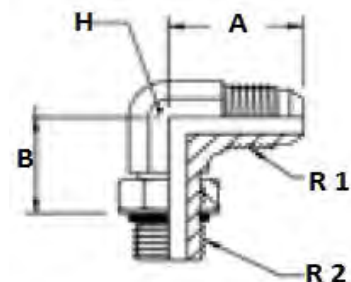

Codo 90° Macho Orientable SAE-JIC

REFERENCIA	ROSCA 1	ROSCA 2	A	B	H
79026-04-04	7/16"-20	7/16"-20	22,5	26	14
79026-04-05	7/16"-20	1/2"-20	24	27,5	14
79026-05-05	1/2"-20	1/2"-20	24	27,5	14
79026-06-06	9/16"-18	9/16"-18	27	31,5	14
79026-06-08	9/16"-18	3/4"-16	28,5	36	14
79026-08-08	3/4"-16	3/4"-16	31,5	36,5	19
79026-08-10	3/4"-16	7/8"-14	34	43	19
79026-10-08	7/8"-14	3/4"-16	36,5	39,5	19
79026-10-10	7/8"-14	7/8"-14	36,5	43	22
79026-12-10	1-1/16"-12	7/8"-14	42	45,5	22
79026-12-12	1-1/16"-12	1-1/16"-12	42	49	27
79026-16-12	1-5/16"-12	1-1/16"-12	46	52	27
79026-16-16	1-5/16"-12	1-5/16"-12	46	52	33
79026-20-20	1-5/8"-12	1-5/8"-12	52	57	33
79026-24-24	1-7/8"-12	1-7/8"-12	59	61	41

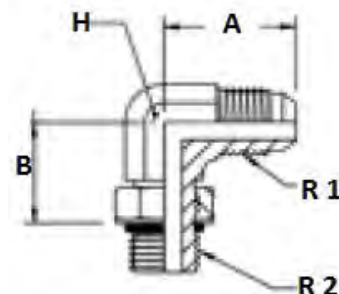

Codo 90° Macho Tuerca Giratoria JIC

REFERENCIA	ROSCA 1	A	B	H	EX
79033-04-04	7/16"-20	22,5	26	14	17
79033-05-05	1/2"-20	24	28,5	14	19
79033-06-06	9/16"-18	27	30	14	19
79033-08-08	3/4"-16	31,5	35,5	19	24
79033-10-10	7/8"-14	36,5	42	22	27
79033-12-12	1-1/16"-12	42	44,5	27	32
79033-16-16	1-5/16"-12	46	50	33	38
79033-20-20	1-5/8"-12	52,5	59	41	50
79033-24-24	1-7/8"-12	59	65,5	48	55

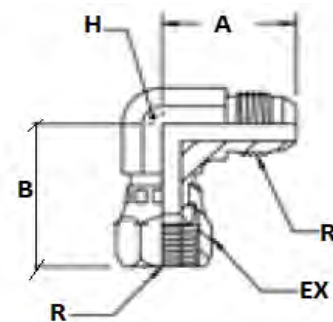

Codo 45° Macho Orientable JIC-BSP

REFERENCIA	ROSCA 1	ROSCA 2	A	B	H
79229-04-02	7/16"20	1/8"-28	18	26,5	14
79229-05-04	1/2"-20	1/4"-19	21	29	16
79229-06-04	9/16"-18	1/4"-19	21	29	17
79229-08-06	3/4"-16	3/8"-19	25	33	22
79229-08-08	3/4"-16	1/2"-14	25,5	38,5	27
79229-10-08	7/8"-14	1/2"-14	28	38,5	27
79229-12-08	1-1/16"-12	1/2"-14	32,5	40,5	32
79229-12-12	1-1/16"-12	3/4"-14	32,5	44	38
79229-16-16	1-5/16"-12	1"-11	37	47	57

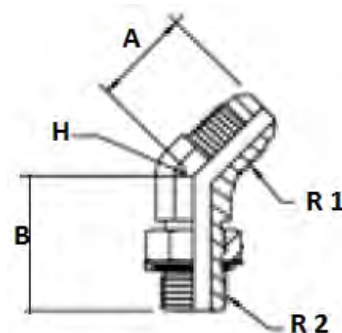

Codo 45° Macho-Hembra Giratoria JIC

REFERENCIA	ROSCA	A	B	H	EX
79230-04-04	7/16"-20	18	24,5	14	17
79230-05-05	1/2"-20	19,5	26,5	14	19
79230-06-06	9/16"-18	21	28,5	14	19
79230-08-08	3/4"-16	25	32	19	24
79230-10-10	7/8"-14	28	37	22	27
79230-12-12	1-1/16"-12	32,5	45,5	27	32
79230-16-16	1-5/16"-12	37	45	33	38

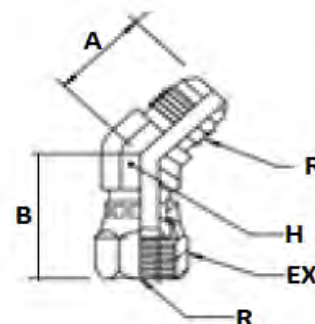

T Macho JIC

REFERENCIA	ROSCA	A	B	H
79800-04-04	7/16"-20	45	22,5	14
79800-05-05	1/2"-20	48	24	14
79800-06-06	9/16"-18	54	27	14
79800-08-08	3/4"-16	63	31,5	19
79800-10-10	7/8"-14	73	36,5	22
79800-12-12	1-1/16"-12	84	42	27
79800-16-16	1-5/16"-12	92	46	33
79800-20-20	1-5/8"-12	104	52	41

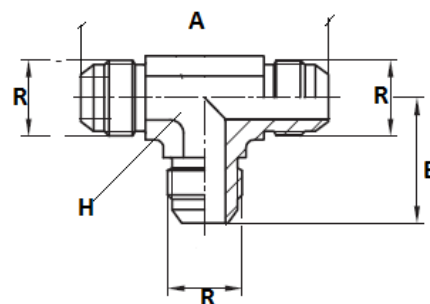

T Macho Orientable Lateral JIC-BSP

REFERENCIA	ROSCA 1	ROSCA 2	A	B	H
79827-04-02	7/16"-20	1/8"-28	43,5	22,5	14
79827-05-02	1/2"-20	1/8"-28	43,5	22,5	14
79827-06-04	9/16"-18	1/4"-19	53,5	27	14
79827-08-06	3/4"-16	3/8"-19	62	31,5	19
79827-10-08	7/8"-14	1/2"-14	72,5	36,5	22
79827-12-12	1-1/16"-12	3/4"-14	82,5	42	27
79827-16-16	1-5/16"-12	1"-11	90	46	33
79827-20-20	1-5/8"-12	1-1/4"-11	102	52	41

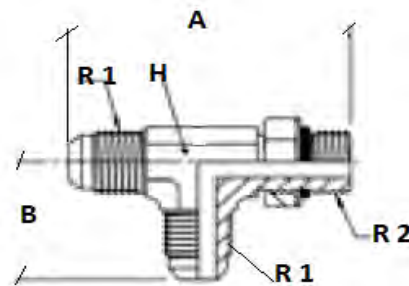

T Macho Orientable Central JIC-BSP

REFERENCIA	ROSCA 1	ROSCA 2	A	B	H
79826-04-04	7/16"-20	1/4"-19	45	22,5	14
79826-05-05	1/2"-20	1/4"-19	48	27	14
79826-06-06	9/16"-18	3/8"-19	54	27	14
79826-08-08	3/4"-16	1/2"-14	63	31,5	19
79826-10-10	7/8"-14	5/8"-14	73	36,5	22
79826-12-12	1-1/16"-12	3/4"-14	84	42	27
79826-16-16	1-5/16"-12	1"-11	92	46	33
79826-20-20	1-5/8"-12	1-1/4"-11	104	52	41

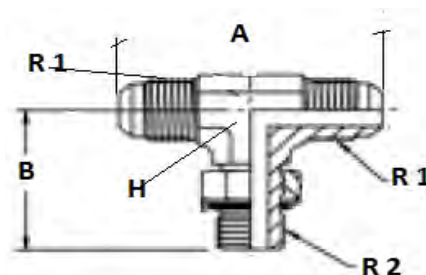

T Macho Orientable Lateral JIC-BSP

REFERENCIA	ROSCA 1	ROSCA 2	A	B	H
79829-04-04	7/16"-20	7/16"-20	43,5	22,5	14
79829-05-05	1/2"-20	1/2"-20	43,5	22,5	14
79829-06-06	9/16"-18	9/16"-18	53,5	27	14
79829-08-08	3/4"-16	3/4"-16	62	31,5	19
79829-10-10	7/8"-14	7/8"-14	72,5	36,5	22
79829-12-12	1-1/16"-12	1-1/16"-12	82,5	42	27
79829-16-16	1-5/16"-12	1-5/16"-12	90	46	33
79829-20-20	1-5/8"-12	1-5/8"-12	104	52	41

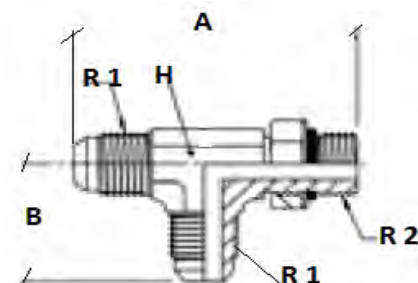

T Macho Orientable Central JIC-SAE

REFERENCIA	ROSCA 1	ROSCA 2	A	B	H
79828-04-04	7/16"-20	7/16"-20	45	22,5	14
79828-05-05	1/2"-20	1/2"-20	48	27	14
79828-06-06	9/16"-18	9/16"-18	54	27	14
79828-08-08	3/4"-16	3/4"-16	63	31,5	19
79828-10-10	7/8"-14	7/8"-14	73	36,5	22
79828-12-12	1-1/16"-12	1-1/16"-12	84	42	27
79828-16-16	1-5/16"-12	1-5/16"-12	92	46	33
79828-20-20	1-5/8"-12	1-5/8"-12	104	52	41

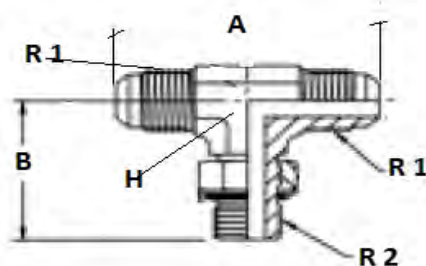

T Macho-Tuerca Giratoria Lateral JIC

REFERENCIA	ROSCA 1	A	B	H	EX
79833-04-04	7/16"-20	48,5	22,5	14	17
79833-05-05	1/2"-20	52	24	14	19
79833-06-06	9/16"-18	58	27	14	19
79833-08-08	3/4"-16	67	31,5	19	24
79833-10-10	7/8"-14	78,5	36,5	22	27
79833-12-12	1-1/16"-12	87,5	42	27	32
79833-16-16	1-5/16"-12	97,5	46	33	38
79833-20-20	1-5/8"-12	111,5	52,5	41	50
79833-24-24	1-7/8"-12	124,5	59	48	55

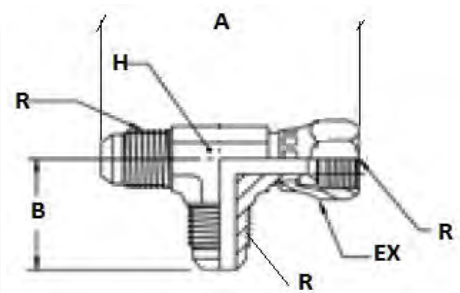

T Macho-Tuerca Giratoria Central JIC

REFERENCIA	ROSCA	A	B	H	EX
79834-04-04	7/16"-20	45	26	14	17
79834-05-05	1/2"-20	48	28	14	19
79834-06-06	9/16"-18	54	31	14	19
79834-08-08	3/4"-16	63	35,5	19	24
79834-10-10	7/8"-14	73	42	22	27
79834-12-12	1-1/16"-12	84	45,5	27	32
79834-16-16	1-5/16"-12	92	51,5	33	38
79834-20-20	1-5/8"-12	105	59	41	50
79834-24-24	1-7/8"-12	118	65,5	48	55

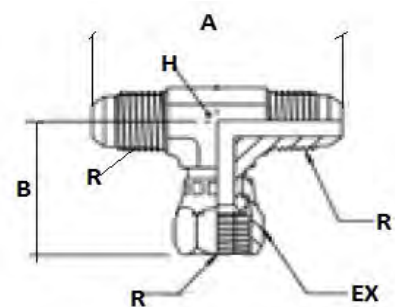

Pasatabique JIC

REFERENCIA	ROSCA	A	B	EX
72224-04-04	7/16"-20	52,5	31,5	14
72224-05-05	1/2"-20	52,5	31,5	14
72224-06-06	9/16"-18	55,5	33,5	17
72224-08-08	3/4"-16	62	37,5	19
72224-10-10	7/8"-14	69,5	41	24
72224-12-12	1-1/16"-12	78,5	45,5	30
72224-16-16	1-5/16"-12	80	45,5	36
72224-20-20	1-5/8"-12	84	46,5	46
72224-24-24	1-7/8"-12	89,5	47	50

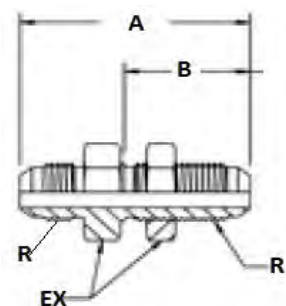

Pasatabique 90° JIC

REFERENCIA	ROSCA	A	B	C	H	EX
79227-04-04	7/16"-20	24,5	26	40	14	17
79227-05-05	1/2"-20	26	26	44	14	19
79227-06-06	9/16"-18	27,5	28	46	14	22
79227-08-08	3/4"-16	34,5	32	54	19	24
79227-10-10	7/8"-14	39,5	35	61	22	30
79227-12-12	1-1/16"-12	45	40	68	27	36
79227-16-16	1-5/16"-12	49	40	71	33	38

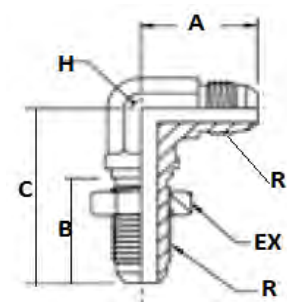

Tapón Hembra JIC

REFERENCIA	ROSCA	A	EX
72501-05-05	1/2"-20	20	7
72501-06-06	9/16"-18	22	19
72501-08-08	3/4"-16	24	22
72501-10-10	7/8"-14	27	27
72501-12-12	1-1/16"-12	30	32
72501-16-16	1-5/16"-12	31,5	41
72501-20-20	1-5/8"-12	33	50
72501-24-24	1-7/8"-12	39	60

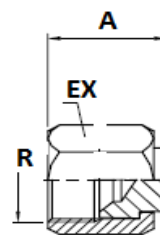

Tapón Macho JIC

REFERENCIA	ROSCA	A	EX
H4250010-04-04	7/16"-20	20,5	14
H4250010-05-05	1/2"-20	20,5	14
H4250010-06-06	9/16"-18	21,5	17
H4250010-08-08	3/4"-16	24,5	19
H4250010-10-10	7/8"-14	28	24
H4250010-12-12	1-1/16"-12	32,5	30
H4250010-16-16	1-5/16"-12	34	36
H4250010-20-20	1-5/8"-12	37	46
H4250010-24-24	1-7/8"-12	42	50

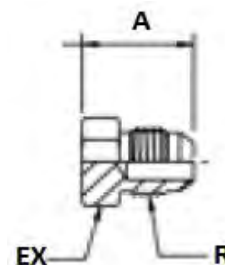

Reducción Macho Hembra JIC

REFERENCIA	ROSCA 1	ROSCA 2	A	B	EX
72227-06-04	9/16"-18	7/16"-20	24,5	24,5	19
72227-06-05	9/16"-18	1/2"-20	28	24,5	19
72227-08-04	3/4"-16	7/16"-20	25,5	25,5	22
72227-08-05	3/4"-16	1/2"-20	25,5	25,5	22
72227-08-06	3/4"-16	9/16"-18	25,5	25,5	22
72227-10-05	7/8"-14	1/2"-20	31	26	27
72227-10-04	7/8"-14	7/16"-20	31	26	27
72227-10-08	7/8"-14	3/4"-16	37	29	27
72227-10-06	7/8"-14	9/16"-18	41	26	27
72227-12-04	1-1/16"-12	7/16"-20	47	27,5	32
72227-12-06	1-1/16"-12	9/16"-18	47	27,5	32
72227-12-08	1-1/16"-12	3/4"-16	50	30,5	32
72227-12-10	1-1/16"-12	7/8"-14	42	30,5	32
72227-12-12	1-1/16"-12	1-1/16"-12	50	30,5	41
72227-16-12	1-5/16"-12	1-1/16"-12	55	37,5	50
72227-20-12	1-5/8"-12	1-1/16"-12	62	39	50
72227-20-16	1-5/8"-12	1-5/16"-12	64	40	60
72227-24-20	1-7/8"-12	1-5/8"-12	70	43	60

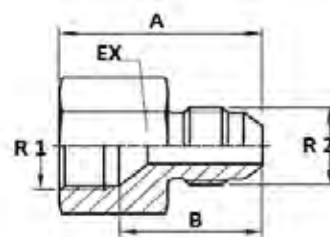
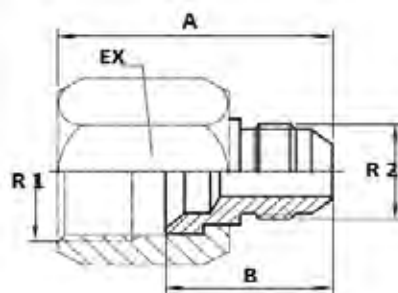

Reducción Macho Hembra Fijo JIC-BSP

REFERENCIA	ROSCA 1	ROSCA 2	A	B	EX
72226-04-02	7/16"-20	1/8"-28	30	16	19
72226-04-04	7/16"-20	1/4"-19	35,5	21,5	17
72226-05-02	1/2"-20	1/8"-28	30	16	19
72226-05-04	1/2"-20	1/4"-19	35,5	21,5	19
72226-06-04	9/16"-18	1/4"-19	35,5	21,5	22
72226-06-06	9/16"-18	3/8"-19	36,5	22,5	22
72226-08-06	3/4"-16	3/8"-19	39,5	22,5	27
72226-08-08	3/4"-16	1/2"-14	45,5	28,5	27
72226-10-08	7/8"-14	1/2"-14	48	28,5	32
72226-12-08	1-1/16"-12	1/2"-14	50,5	28,5	32
72226-12-12	1-1/16"-12	3/4"-14	52,5	30,5	41
72226-16-16	1-5/16"-12	1"-11	59,5	36,5	50
72226-20-20	1-5/8"-12	1-1/4"-11	63	38,5	60
72226-24-24	1-7/8"-12	1-1/2"-11	66,5	39	

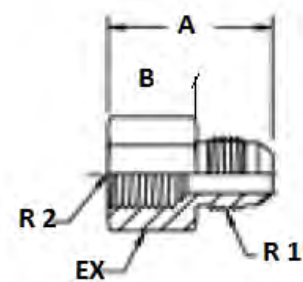

Unión Hembra Giratoria JIC

REFERENCIA	ROSCA	A	B	H	EX
H7252511-04-04	7/16"-20	41,5	23,6	14	17
H7252511-05-05	1/2"-20	43,5	24	16	19
H7252511-06-06	9/16"-18	45	25,5	17	19
H7252511-08-08	3/4"-16	52	30,4	22	24
H7252511-10-10	7/8"-14	59,5	34,5	27	27
H7252511-12-12	1-1/16"-12	63	34,5	32	32
H7252511-16-16	1-5/16"-12	72	41	38	38
H7252511-20-20	1-5/8"-12	78,5	46	46	50
H7252511-24-24	1-7/8"-12	85	46,5	50	55

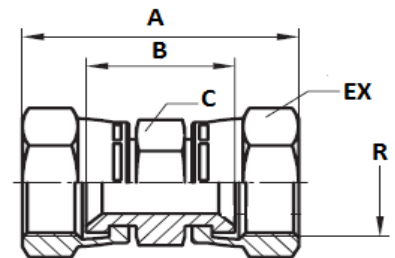

Macho Soldable JIC

REFERENCIA	ROSCA	A	B	C
72228-04-04	7/16"-20	23	12	14
72228-05-05	1/2"-20	24	12	14
72228-06-06	9/16"-18	24	14	14
72228-08-08	3/4"-16	27	20	16,5
72228-10-10	7/8"-14	30	22	19
72228-12-12	1-1/16"-12	34	28	22
72228-16-16	1-5/16"-12	37	34	23

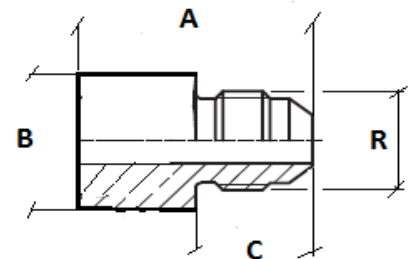

Codo 90° Macho Orientable Métrico-ORFS

REFERENCIA	ROSCA 1	ROSCA 2	A	B	C	D	EX
49027-04-10	M10X1	9/16"-18	22	31	21	14	14
49027-04-12	M12X1,5	9/16"-18	22	33	22	14	17
49027-04-14	M14X1,5	9/16"-18	24	36	25	14	19
49027-06-12	M12X1,5	11/16"-16	25	36	25	19	17
49027-06-14	M14X1,5	11/16"-16	25	36	25	19	19
49027-06-16	M16X1,5	11/16"-16	25	38	27	19	22
49027-08-14	M14X1,5	13/16"-16	28	36	25	19	19
49027-08-16	M16X1,5	13/16"-16	28	38	27	19	22
49027-08-18	M18X1,5	13/16"-16	28	41	27	19	24
49027-08-22	M22X1,5	13/16"-16	31	49	35	27	27
49027-10-18	M18X1,5	1"-14	33	48	36	27	24
49027-10-22	M22X1,5	1"-14	33	49	34	27	27
49027-12-22	M22X1,5	1-3/16"-12	37	50	35	30	27
49027-12-27	M27X2	1-3/16"-12	37	56	40	30	32
49027-16-33	M33X2	1-7/16"-12	42	59	43	36	41
49027-20-33	M33X2	1-11/16"-12	45	62	46	41	41
49027-20-42	M42X2	1-11/16"-12	45	63	46	41	50
49027-24-48	M48X2	2"-12	49	72	53	50	55

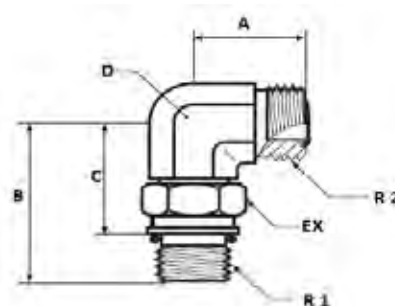

Codo 90° Macho Orientable UNF-ORFS

REFERENCIA	ROSCA 1	ROSCA 2	A	B	C	D	EX
49024-04-04	7/16"20	9/16"-18	33	33	22	14	14
49024-04-06	9/16"-18	9/16"-18	37	37	25	19	19
49024-04-08	3/4"-16	9/16"-18	41	41	27	19	19
49024-06-06	9/16"-18	11/16"-16	37	37	25	19	19
49024-06-04	7/16"-20	11/16"-16	35	35	24	19	19
49024-06-08	3/4"-16	11/16"-16	41	41	27	19	19
49024-06-10	7/8"-14	11/16"-16	50	50	34	22	22
49024-06-12	1-1/16"-12	11/16"-16	55	55	37	27	27
49024-08-08	3/4"-16	13/16"-16	41	41	27	19	19
49024-08-06	9/16"-18	13/16"-16	37	37	25	19	19
49024-08-10	7/8"-14	13/16"-16	50	50	34	27	27
49024-08-12	1-1/16"-12	13/16"-16	55	55	37	30	30
49024-10-10	7/8"-14	1"-14	50	50	34	27	27
49024-10-08	3/4"-16	1"-14	46	46	32	27	27
49024-10-12	1-1/16"-12	1"-14	55	55	37	30	30
49024-12-12	1-1/16"-12	1-3/16"-12	55	55	37	30	30
49024-12-08	3/4"-16	1-3/16"-12	47	47	33	30	30
49024-12-10	7/8"-14	1-3/16"-12	51	51	35	30	30
49024-12-16	1-5/16"-12	1-3/16"-12	60	60	41	36	36
49024-16-16	1-5/16"-12	1-7/16"-12	60	60	38	37	37
49024-16-12	1-1/16"-12	1-7/16"-12	59	59	40	37	37
49024-16-20	1-5/8"-12	1-7/16"-12	62	62	44	41	41
49024-20-20	1-5/8"-12	1-11/16"-12	62	62	44	41	41
49024-20-16	1-5/16"-12	1-11/16"-12	62	62	43	41	41
49024-20-24	1-7/8"-12	1-11/16"-12	66	66	47	48	48
49024-24-24	1-7/8"-12	2"-12	66	66	47	48	48
49024-24-20	1-5/8"-12	2"-12	66	66	47	48	48
49024-32-32	2-1/2"-12	2-1/2"-12	78	78	59	64	64

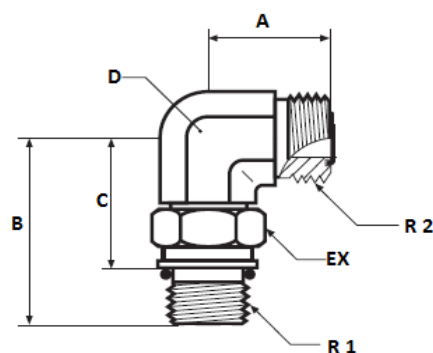

Unión Doble Macho ORFS

REFERENCIA	ROSCA 1	ROSCA 2	A	EX
H8454510-04-04	9/16"-18	9/16"-18	27	17
H8454510-06-06	11/16"-16	11/16"-16	31	19
H8454510-06-04	11/16"-16	9/16"-18	30	19
H8454510-08-08	13/16"-16	13/16"-16	35	22
H8454510-08-06	13/16"-16	11/16"-16	34	22
H8454510-10-10	1"-14	1"-14	43	27
H8454510-10-08	1"-14	13/16"-16	40	27
H8454510-12-12	1-3/16"-12	1-3/16"-12	47	32
H8454510-12-10	1-3/16"-12	1"-14	46	32
H8454510-16-16	1-7/16"-12	1-7/16"-12	49	41
H8454510-16-12	1-7/16"-12	1-3/16"-12	49	41
H8454510-20-20	1-11/16"-12	1-11/16"-12	51	46
H8454510-20-16	1-11/16"-12	1-7/16"-12	51	46
H8454510-24-24	2"-12	2"-12	53	55
H8454510-24-20	2"-12	1-11/16"-12	53	55
H8454510-32-32	2-1/2"-12	2-1/2"-12	73	70

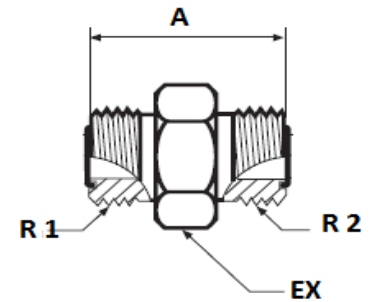

Codo 90° Macho ORFS

REFERENCIA	ROSCA	A	H
H8454590-04-04	9/16"-18	22	14
H8454590-06-06	11/16"-16	25	19
H8454590-08-08	13/16"-16	28	19
H8454590-10-10	1"-14	33	27
H8454590-12-12	1-3/16"-12	37	30
H8454590-16-16	1-7/16"-12	42	37
H8454590-20-20	1-11/16"-12	45	41
H8454590-24-24	2"-12	49	48
H8454590-32-32	2-1/2"-12	70	64

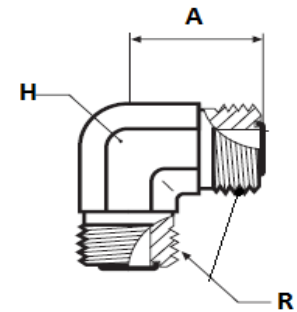

T Macho ORFS

REFERENCIA	ROSCA	A	H
49800-04-04	9/16"-18	44	14
49800-06-06	11/16"-16	50	19
49800-08-08	13/16"-16	56	19
49800-10-10	1"-14	66	27
49800-12-12	1-3/16"-12	74	30
49800-16-16	1-7/16"-12	82	36
49800-20-20	1-11/16"-12	90	41
49800-24-24	2"-12	98	48
49800-32-32	2-1/2"-12	140	64

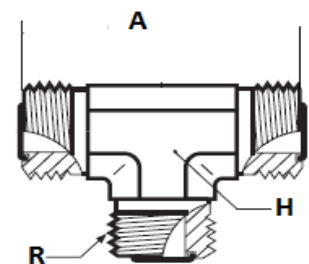

Cruz Macho

REFERENCIA	ROSCA	A	H
49835-04-04	9/16"-18	44	14
49835-06-06	11-16"-16	50	19
49835-08-08	13/16"-16	56	19
49835-10-10	1"-14	66	27
49835-12-12	1-3/16"-12	74	30
49835-16-16	1-7/16"-12	84	37
49835-20-20	1-11/16"-12	90	41
49835-24-24	2"-12	98	48

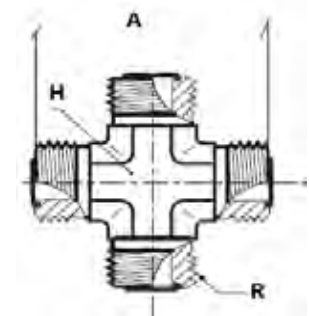

Pasatabique Macho ORFS

REFERENCIA	ROSCA	A	B	C	D	EX
42224-04-04	9/16"-18	49	32	2	14	22
42224-06-06	11-16"-16	53	34	2	17	27
42224-08-08	13/16"-16	58	37	3	20	30
42224-10-10	1"-14	67	41	3	25	32
42224-12-12	1-3/16"-12	69	42	3	30	41
42224-16-16	1-7/16"-12	70	42	3	36	46
42224-20-20	1-11/16"-12	70	42	2	43	51
42224-24-24	2"-12	70	42	2	51	60

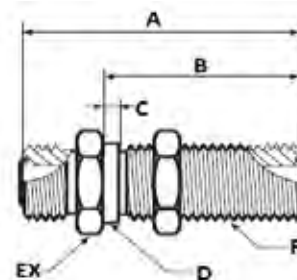

Codo 90° Macho Pasatabique ORFS

REFERENCIA	ROSCA	A	B	C	D	EX	H
49037-04-04	9/16"-18	46	23	32	2	32	14
49037-06-06	11-16"-16	52	26	34	2	34	19
49037-08-08	13/16"-16	56	29	37	3	37	19
49037-10-10	1"-14	63	35	41	3	41	27
49037-12-12	1-3/16"-12	67	39	42	3	42	30
49037-16-16	1-7/16"-12	71	42	42	2	42	37
49037-20-20	1-11/16"-12	75	45	42	2	42	41
49037-24-24	2"-12	80	50	42	2	42	48

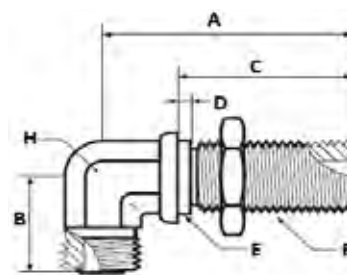

Codo 45° Macho Pasatabique ORFS

REFERENCIA	ROSCA	A	B	C	D	EX	H
49038-04-04	9/16"-18	44	16	32	2	14	14
49038-06-06	11-16"-16	49	19	34	2	18	19
49038-08-08	13/16"-16	51	20	37	2	21	19
49038-10-10	1"-14	57	23	41	2	25	27
49038-12-12	1-3/16"-12	61	26	42	2	30	30
49038-16-16	1-7/16"-12	65	30	42	2	37	37
49038-20-20	1-11/16"-12	67	32	42	2	43	41
49038-24-24	2"-12	67	37	42	2	51	48

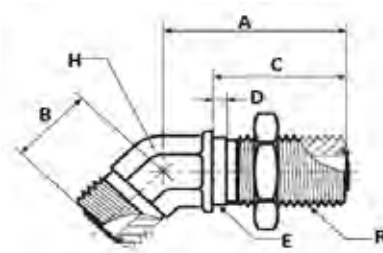

Codo 90° Macho Hembra Giratoria ORFS

REFERENCIA	ROSCA	A	B	H	EX
49033-04-04	9/16"-18	26	22	14	17
49033-06-06	11-16"-16	29	25	19	22
49033-08-08	13/16"-16	38	28	19	24
49033-10-10	1"-14	41	33	27	30
49033-12-12	1-3/16"-12	46	37	30	36
49033-16-16	1-7/16"-12	53	42	36	41
49033-20-20	1-11/16"-12	58	45	41	48
49033-24-24	2"-12	61	49	48	57

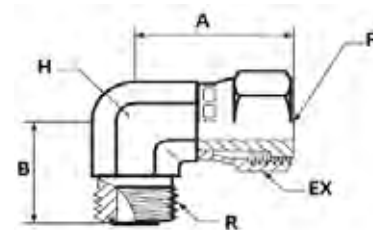

Codo 45° Macho Pasatabique ORFS

REFERENCIA	ROSCA	A	B	H	EX
49028-04-04	9/16"-18	16	25	14	18
49028-06-06	11-16"-16	19	28	19	21
49028-08-08	13/16"-16	20	38	19	24
49028-10-10	1"-14	23	38	27	29
49028-12-12	1-3/16"-12	26	44	30	35
49028-16-16	1-7/16"-12	30	48	36	42
49028-20-20	1-11/16"-12	32	50	41	48
49028-24-24	2"-12	37	52	48	58

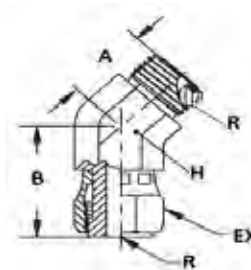

T Macho Hembra Giratoria Central ORFS

REFERENCIA	ROSCA	A	B	H	EX
49834-04-04	9/16"-18	44	26	14	17
49834-06-06	11-16"-16	50	29	19	22
49834-08-08	13/16"-16	56	38	19	24
49834-10-10	1"-14	66	41	27	30
49834-12-12	1-3/16"-12	74	46	30	35
49834-16-16	1-7/16"-12	84	53	37	41
49834-20-20	1-11/16"-12	90	58	41	48
49834-24-24	2"-12	98	61	48	57

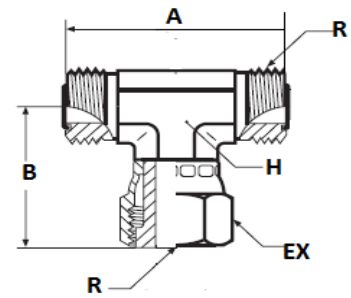

T Macho Hembra Giratoria Lateral ORFS

REFERENCIA	ROSCA	A	H	EX
49833-04-04	9/16"-18	48	14	17
49833-06-06	11-16"-16	54	19	22
49833-08-08	13/16"-16	66	19	24
49833-10-10	1"-14	74	27	30
49833-12-12	1-3/16"-12	83	30	35
49833-16-16	1-7/16"-12	95	37	41
49833-20-20	1-11/16"-12	104	41	48
49833-24-24	2"-12	110	48	57

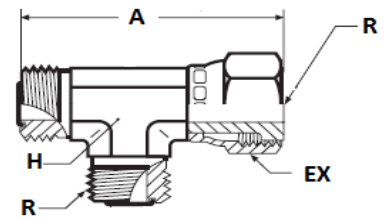

Unión Macho Tuerca Giratoria ORFS

REFERENCIA	ROSCA 1	ROSCA 2	A	EX
H9454511-06-04	11/16"-16	9/16"-18	20	22
H9454511-08-04	13/16"-16	9/16"-18	22	24
H9454511-08-06	13/16"-16	11/16"-16	22	24
H9454511-10-04	1"-14	9/16"-18	23	30
H9454511-10-06	1"-14	11/16"-16	24	30
H9454511-10-08	1"-14	13/16"-16	26	30
H9454511-12-04	1-3/16"-12	9/16"-18	25	35
H9454511-12-06	1-3/16"-12	11/16"-16	26	35
H9454511-12-08	1-3/16"-12	13/16"-16	28	35
H9454511-12-10	1-3/16"-12	1"-14	30	35
H9454511-16-08	1-7/16"-12	13/16"-16	29	41
H9454511-16-12	1-7/16"-12	1-3/16"-12	32	41
H9454511-20-12	1-11/16"-12	1-3/16"-12	33	48
H9454511-20-16	1-11/16"-12	1-7/16"-12	34	48
H9454511-24-16	2"-12	1-7/16"-12	38	57
H9454511-24-20	2"-12	1-11/16"-12	31	57
H9454511-32-20	2-1/2"-12	1-11/16"-12	34	65
H9454511-32-24	2-1/2"-12	2"-12	36	65

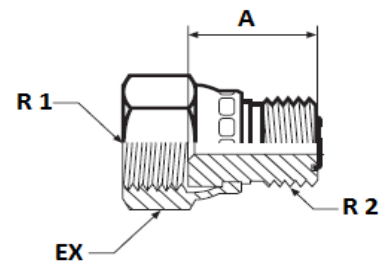

Unión Hembra Giratoria ORFS

REFERENCIA	ROSCA	A	EX1	EX2
H7454511-04-04	9/16"-18	40,5	18	17
H7454511-06-06	11-16"-16	45	21	19
H7454511-08-08	13/16"-16	54	24	22
H7454511-10-10	1"-14	61,5	29	27
H7454511-12-12	1-3/16"-12	70	35	32
H7454511-16-16	1-7/16"-12	76	42	41
H7454511-20-20	1-11/16"-12	79	48	46
H7454511-24-24	2"-12	61	57	55

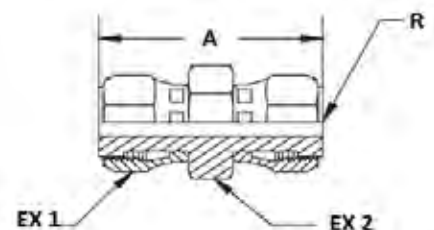

Unión Doble Macho Métrico ORFS

REFERENCIA	ROSCA 1	ROSCA 2	A	B	EX
H8304510-10-04	M-10X1	9/16"-18	27	18	17
H8304510-12-04	M-12X1,5	9/16"-18	29	18	17
H8304510-14-04	M-14X1,5	9/16"-18	30	19	19
H8304510-12-06	M-12X1,5	11/16"-16	34	23	19
H8304510-14-06	M-14X1,5	11/16"-16	31	20	19
H8304510-16-06	M-16X1,5	11/16"-16	34	21	22
H8304510-18-06	M-18X1,5	11/16"-16	35	21	24
H8304510-22-06	M-22X1,5	11/16"-16	38	23	27
H8304510-14-08	M-14X1,5	13/16"-16	35	24	22
H8304510-16-08	M-16X1,5	13/16"-16	37	20	22
H8304510-18-08	M-18X1,5	13/16"-16	37	23	24
H8304510-22-08	M-22X1,5	13/16"-16	39	24	27
H8304510-27-08	M-27X2	13/16"-16	44	26	32
H8304510-18-10	M-18X1,5	1"-14	41	27	27
H8304510-22-10	M-22X1,5	1"-14	42	27	27
H8304510-22-12	M-22X1,5	1-3/16"-12	50	35	32
H8304510-27-12	M-27X2	1-3/16"-12	49	30	32
H8304510-33-12	M-33X2	1-3/16"-12	50	31	41
H8304510-27-16	M-27X2	1-7/16"-12	54	36	41
H8304510-33-16	M-33X2	1-7/16"-12	52	34	41
H8304510-33-20	M-33X2	1-11/16"-12	54	36	46
H8304510-42-20	M-42X2	1-11/16"-12	55	36	50
H8304510-42-24	M-42X2	2"-12	60	41	55
H8304510-48-24	M-48X2	2"-12	57	36	55
H8304510-60-32	M-60X2	2-1/2"-12	65	41	65

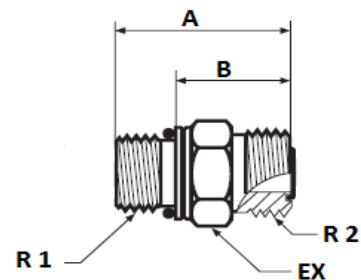

Unión Doble Macho SAE- ORFS

REFERENCIA	ROSCA 1	ROSCA 2	A	B	EX
H8254510-04-04	7/16"-20	9/16"-18	29	18	17
H8254510-04-05	1/2"-20	9/16"-18	29	19	17
H8254510-04-06	9/16"-18	9/16"-18	31	19	19
H8254510-04-08	3/4"-16	9/16"-18	34	20	22
H8254510-06-06	9/16"-18	11/16"-16	32	20	19
H8254510-06-04	7/16"-20	11/16"-16	34	23	19
H8254510-06-05	1/2"-20	11/16"-16	31	21	19
H8254510-06-08	3/4"-16	11/16"-16	35	21	22
H8254510-06-10	7/8"-14	11/16"-16	39	23	27
H8254510-08-08	3/4"-16	13/16"-16	37	23	22
H8254510-08-06	9/16"-18	13/16"-16	38	26	22
H8254510-08-10	7/8"-14	13/16"-16	40	24	27
H8254510-08-12	1-1/16"-12	13/16"-16	44	26	32
H8254510-08-16	1-5/16"-12	13/16"-16	46	27	38
H8254510-10-10	7/8"-14	1"-14	43	27	27
H8254510-10-08	3/4"-16	1"-14	45	31	27
H8254510-10-12	1-1/16"-12	1"-14	47	29	32
H8254510-12-12	1-1/16"-12	1-3/16"-12	49	30	32
H8254510-12-08	3/4"-16	1-3/16"-12	49	35	32
H8254510-12-10	7/8"-14	1-3/16"-12	51	35	32
H8254510-12-16	1-5/16"-12	1-3/16"-12	50	31	38
H8254510-12-20	1-5/8"-12	1-3/16"-12	51	32	46
H8254510-16-16	1-5/16"-12	1-7/16"-12	50	32	41
H8254510-16-12	1-1/16"-12	1-7/16"-12	55	36	41
H8254510-16-20	1-5/8"-12	1-7/16"-12	52	34	46
H8254510-20-20	1-5/8"-12	1-11/16"-12	52	34	46
H8254510-20-16	1-5/16"-12	1-11/16"-12	58	39	48
H8254510-20-24	1-7/8"-12	1-11/16"-12	54	36	54
H8254510-24-24	1-7/8"-12	2"-12	54	36	54
H8254510-24-20	1-5/8"-12	2"-12	60	41	54
H8254510-32-32	2-1/2"-12	2-1/2"-12	59	40	70

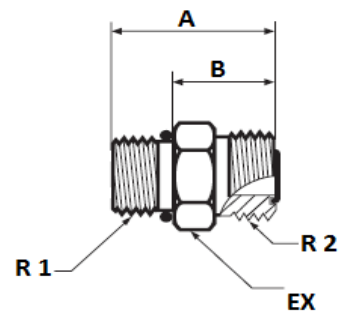

Unión Doble BSP-ORFS

REFERENCIA	ROSCA 1	ROSCA 2	A	B	EX
H8054510-04-02	1/8"-28	9/16"-18	26	18	17
H8054510-04-04	1/4"-19	9/16"-18	31	18	19
H8054510-04-06	3/8"-19	9/16"-18	32	20	22
H8054510-04-08	1/2"-14	9/16"-18	35	21	27
H8054510-06-04	1/4"-19	11/16"-16	32	20	19
H8054510-06-02	1/8"-28	11/16"-16	31	23	19
H8054510-06-06	3/8"-19	11/16"-16	33	21	22
H8054510-06-08	1/2"-14	11/16"-16	37	23	27
H8054510-06-12	3/4"-14	11/16"-16	40	24	32
H8054510-08-06	3/8"-19	13/16"-16	35	23	22
H8054510-08-04	1/4"-19	13/16"-16	38	25	22
H8054510-08-08	1/2"-14	13/16"-16	38	24	27
H8054510-08-12	3/4"-14	13/16"-16	42	26	32
H8054510-10-08	1/2"-14	1"-14	41	27	27
H8054510-10-06	3/8"-19	1"-14	43	31	27
H8054510-10-12	3/4"-14	1"-14	45	29	32
H8054510-10-16	1"-11	1"-14	48	30	41
H8054510-12-12	3/4"-14	1-3/16"-12	46	30	32
H8054510-12-08	1/2"-14	1-3/16"-12	49	34	32
H8054510-12-16	1"-11	1-3/16"-12	49	31	41
H8054510-12-20	1-1/4"-11	1-3/16"-12	53	33	50
H8054510-16-16	1"-11	1-7/16"-12	50	32	41
H8054510-16-08	1/2"-11	1-7/16"-12	50	36	41
H8054510-16-12	3/4"-14	1-7/16"-12	52	36	41
H8054510-16-20	1-1/4"-11	1-7/16"-12	54	34	50
H8054510-16-24	1-1/2"-11	1-7/16"-12	58	36	55
H8054510-20-20	1-1/4"-11	1-11-16"-12	54	34	50
H8054510-20-16	1"-11	1-11-16"-12	57	39	46
H8054510-20-24	1-1/2"-11	1-11-16"-12	58	36	55
H8054510-24-24	1-1/2"-11	2"-12	58	36	55
H8054510-24-20	1-1/4"-11	2"-112	61	41	55
H8054510-32-32	2"-11	2-1/2"-12	65	41	75

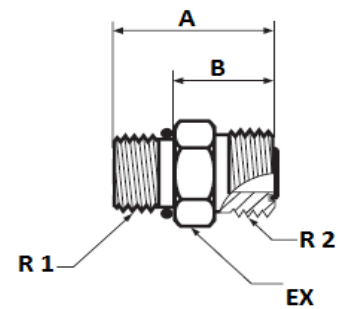

Unión Doble Macho NPTF- ORFS

REFERENCIA	ROSCA 1	ROSCA 2	A	B	EX
H8074510-04-02	1/8"-27	9/16"-18	27	16	16
H8074510-04-04	1/4"-18	9/16"-18	32	16	16
H8074510-04-06	3/8"-18	9/16"-18	36	19	19
H8074510-06-04	1/4"-18	11/16"-16	32	19	19
H8074510-06-06	3/8"-18	11/16"-16	34	19	19
H8074510-06-08	1/2"-14	11/16"-16	39	22	22
H8074510-06-08	1/2"-14	13/16"-16	38	22	22
H8074510-08-08	1/2"-14	13/16"-16	42	22	22
H8074510-08-12	3/4"-14	13/16"-16	43	29	29
H8074510-10-08	1/2"-14	1"-14	46	27	27
H8074510-10-12	3/4"-14	1"-14	46	29	29
H8074510-12-12	3/4"-14	1-3/16"-12	49	32	32
H8074510-12-08	1/2"-14	1-3/16"-12	49	32	32
H8074510-12-16	1"-11-1/2	1-3/16"-12	54	35	35
H8074510-16-16	1"-11-1/2	1-7/16"-12	56	38	38
H8074510-16-12	3/4"-14	1-7/16"-12	51	38	38
H8074510-20-20	1-1/4"-11-1/2	1-11/16"-12	58	48	48
H8074510-24-24	1-1/2"-11-1/2	2"-12	61	54	54

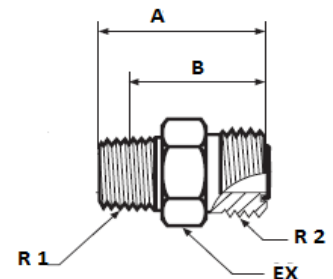

Codo 90° Macho Orientable BSP-ORFS

REFERENCIA	ROSCA 1	ROSCA 2	A	B	C	D	EX
49025-04-02	1/8"-28	9/16"-18	22	30	22	14	14
49025-04-04	1/4"-19	9/16"-18	24	36	25	19	19
49025-04-06	3/8"-19	9/16"-18	25	38	27	19	22
49025-06-04	1/4"-19	11/16"-16	25	36	25	19	19
49025-06-02	1/8"-28	11/16"-16	25	32	24	19	14
49025-06-06	3/8"-19	11/16"-16	27	38	27	19	22
49025-06-08	1/2"-14	11/16"-16	29	49	34	27	27
49025-08-06	3/8"-19	13/16"-16	28	38	27	19	22
49025-08-04	1/4"-19	13/16"-16	28	36	25	19	19
49025-08-08	1/2"-14	13/16"-16	31	49	34	27	27
49025-08-12	3/4"-14	13/16"-16	34	52	37	30	36
49025-10-08	1/2"-14	1"-14	33	49	34	27	27
49025-10-06	3/8"-19	1"-14	33	43	31	27	22
49025-10-12	3/4"-14	1"-14	36	52	37	30	36
49025-10-16	1"-11	1"-14	40	58	41	36	41
49025-12-12	3/4"-14	1-3/16"-12	37	52	37	30	36
49025-12-08	1/2"-14	1-3/16"-12	37	50	35	30	27
49025-12-16	1"-11	1-3/16"-12	41	58	41	36	41
49025-16-16	1"-11	1-7/16"-12	42	58	41	36	41
49025-16-12	3/4"-14	1-7/16"-12	42	55	41	36	36
49025-16-20	1-1/4"-11	1-7/16"-12	45	61	44	41	50
49025-20-20	1-1/4"-11	1-11/16"-12	45	61	44	41	50
49025-20-16	1"-11	1-11/16"-12	45	61	44	41	41
49025-20-24	1-1/2"-11	1-11/16"-12	49	65	47	50	55
49025-24-24	1-1/2"-11	2"-12	49	65	47	50	55

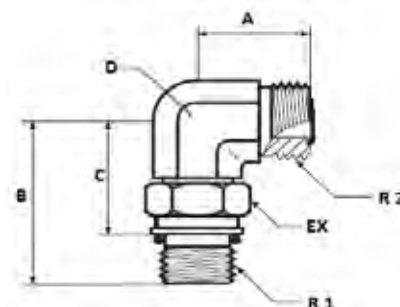

Codo 90° Macho NPTF- ORFS

REFERENCIA	ROSCA 1	ROSCA 2	A	B	C	D
49225-04-02	1/8"-27	9/16"-18	22	20	15	14
49225-04-04	1/4"-18	9/16"-18	22	29	20	14
49225-06-04	1/4"-18	11/16"-16	25	28	19	19
49225-06-06	3/8"-18	11/16"-16	25	31	22	19
49225-06-08	1/2"-14	11/16"-16	29	37	26	22
49225-08-06	3/8"-18	13/16"-16	28	31	22	19
49225-08-08	1/2"-14	13/16"-16	28	37	26	22
49225-08-12	3/4"-14	13/16"-16	34	40	28	27
49225-10-08	1/2"-14	1"-14	33	37	26	27
49225-10-12	3/4"-14	1"-14	36	40	28	30
49225-12-12	3/4"-14	1-3/16"-12	37	40	28	30
49225-12-08	1/2"-14	1-3/16"-12	37	40	29	30
49225-12-16	1"-11-1/2	1-3/16"-12	41	50	36	33
49225-16-16	1"-11-1/2	1-7/16"-12	42	50	36	37
49225-16-12	3/4"-14	1-7/16"-12	42	45	33	37
49225-20-20	1-1/4"-11-1/2	1-11/16"-12	45	61	46	41
49225-24-24	1-1/2"-11-1/2	2"-12	49	67	52	48

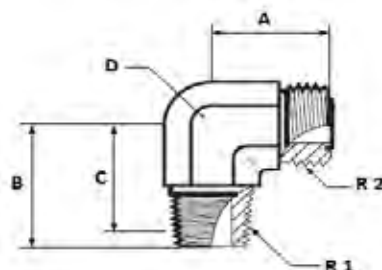

Codo 45° Macho Orientable Métrico-ORFS

REFERENCIA	ROSCA 1	ROSCA 2	A	B	C	D	EX
49227-04-12	M12X1,5	9/16"-18	16	30	19	14	17
49227-06-16	M16X1,5	11-16"-16	19	33	19	19	22
49227-08-18	M18X1,5	13/16"-16	20	37	23	19	24
49227-10-22	M22X1,5	1"-14	23	43	29	27	27
49227-12-27	M27X2	1-3/16"-12	26	50	32	30	32
49227-16-33	M33X2	1-7/16"-12	30	52	34	36	41
49227-20-42	M42X2	1-11/16"-12	32	54	35	41	50
49227-24-48	M48X2	2"-12	37	56	35	50	55

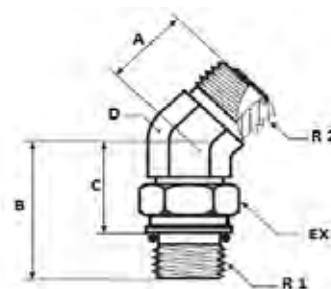

Codo 45° Macho Orientable UNF-ORFS

REFERENCIA	ROSCA 1	ROSCA 2	A	B	C	D	EX
49228-04-04	7/16"-20	9/16"-18	16	30	19	14	17
49228-04-06	9/16"-18	9/16"-18	17	33	21	19	19
49228-06-06	9/16"-18	11/16"-16	19	33	21	19	19
49228-06-04	7/16"-20	11/16"-16	19	31	20	19	16
49228-06-08	3/4"-16	11/16"-16	19	36	23	19	24
49228-08-08	3/4"-16	13/16"-16	20	36	23	19	24
49228-08-06	9/16"-18	13/16"-16	20	32	20	19	19
49228-08-10	7/8"-14	13/16"-16	21	45	29	27	27
49228-10-10	7/8"-14	1"-14	23	45	29	27	27
49228-10-08	3/4"-16	1"-14	23	40	27	27	24
49228-10-12	1-1/16"-12	1"-14	24	50	32	30	36
49228-12-12	1-1/16"-12	1-3/16"-12	26	50	32	30	35
49228-12-10	7/8"-14	1-3/16"-12	26	46	30	30	27
49228-12-16	1-5/16"-12	1-3/16"-12	30	52	34	37	41
49228-16-16	1-5/16"-12	1-7/16"-12	30	52	34	37	38
49228-16-12	1-1/16"-12	1-7/16"-12	30	52	33	36	36
49228-16-20	1-5/8"-12	1-7/16"-12	32	54	35	41	48
49228-20-20	1-5/8"-12	1-11/16"-12	32	54	35	41	48
49228-24-24	1-7/8"-12	2"-12	37	54	35	48	54

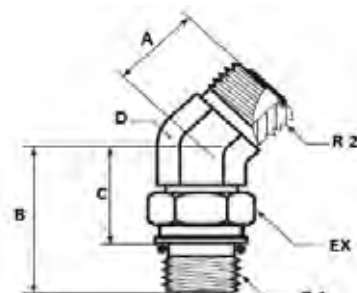

Codo 45° Macho Orientable BSP-ORFS

REFERENCIA	ROSCA 1	ROSCA 2	A	B	C	D	EX
49229-04-02	1/8"-28	9/16"-18	16	28	19	14	14
49229-04-04	1/4"-19	9/16"-18	17	33	21	19	19
49229-06-04	1/4"-19	11/16"-16	19	32	21	19	19
49229-06-06	3/8"-19	11/16"-16	19	34	23	19	22
49229-06-08	1/2"-14	11/16"-16	19	43	28	27	27
49229-08-06	3/8"-19	13/16"-16	20	34	23	19	22
49229-10-08	1/2"-14	1"-14	23	43	29	27	27
49229-10-12	3/4"-14	1"-14	24	46	31	30	36
49229-12-12	3/4"-14	1-3/16"-12	26	46	31	30	36
49229-12-16	1"-11	1-3/16"-12	30	51	34	36	41
49229-16-16	1"-11	1-7/16"-12	30	51	34	36	41
49229-20-20	1-1/4"-11	1-11/16"-12	32	52	35	41	50
49229-24-24	1-1/2"-11	2"-12	37	52	35	50	55

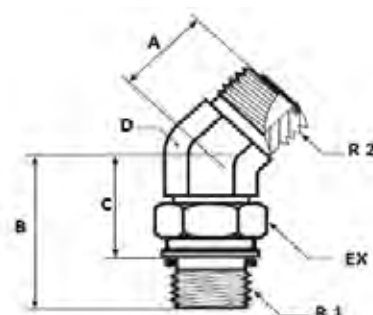

T Macho Orientable Central Métrico-ORFS

REFERENCIA	ROSCA	A	EX1	EX2		
49827-04-12	M12X1,5 9/16"-18	22	33	22	14	17
49827-06-16	M16X1,5 11/16"-16	25	37	27	19	22
49827-08-18	M18X1,5 13/16"-16	28	41	27	19	24
49827-10-22	M22X1,5 1"-14	33	49	34	27	27
49827-12-27	M27X2 1-3/16"-12	37	55	37	30	32
49827-16-33	M33X2 1-7/16"-12	42	59	41	36	41
49827-20-42	M42X2 1-11/16"-12	45	62	44	41	50
49827-24-48	M48X2 2"-12	49	69	48	48	55

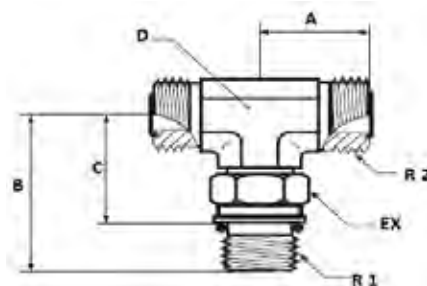

T Macho Orientable Central UNF-ORFS

REFERENCIA	ROSCA 1	ROSCA 2	A	B	C	D	EX
49828-04-04	7/16"-20	9/16"-18	22	33	22	14	16
49828-06-06	9/16"-18	11/16"-16	25	37	25	19	19
49828-06-08	3/4"-16	11/16"-16	26	41	27	19	24
49828-08-08	3/4"-16	13/16"-16	28	41	27	19	24
49828-10-10	7/8"-14	1"-14	33	50	34	27	27
49828-12-12	1-1/16"-12	1-3/16"-12	37	55	37	30	36
49828-16-12	1-1/16"-12	1-3/16"-12	42	60	41	37	42
49828-16-16	1-5/16"-12	1-7/16"-12	42	60	41	37	41
49828-20-20	1-5/8"-12	1-11/16"-12	45	62	44	41	48
49828-24-24	1-7/8"-12	2"-12	49	66	47	48	54

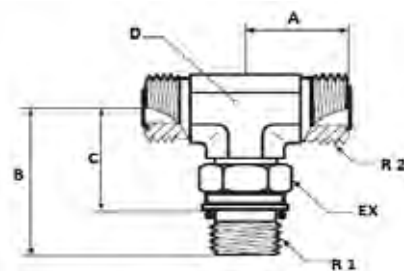

T Macho Orientable Central BSP - ORFS

REFERENCIA	ROSCA 1	ROSCA 2	A	B	C	D	EX
49829-04-02	1/8"-28	9/16"-18	22	30	22	14	14
49829-04-04	1/4"-19	9/16"-18	24	36	25	19	19
49829-06-04	1/4"-19	11/16"-16	25	36	25	19	19
49829-06-06	3/8"-19	11/16"-16	27	38	27	19	22
49829-08-06	3/8"-19	13/16"-16	28	38	27	19	22
49829-08-08	1/2"-14	13/16"-16	31	49	34	27	27
49829-10-08	1/2"-14	1"-14	33	49	34	27	27
49829-10-12	3/4"-14	1"-14	36	52	37	30	36
49829-12-12	3/4"-14	1-3/16"-12	37	52	37	30	36
49829-16-16	1"-11	1-7/16"-12	42	58	41	36	41
49829-20-20	1-1/4"-11	1-11/16"-12	45	61	44	41	50
49829-24-24	1-1/2"-11	2"-12	49	65	47	50	55

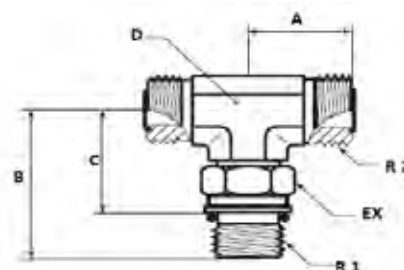

T Macho Orientable Lateral Métrico-ORFS

REFERENCIA	ROSCA 1	ROSCA 2	A	B	C	D	EX
49824-04-12	M-12X1,5	9/16"-18	33	22	22	14	17
49824-06-16	M-16X1,5	11/16"-16	38	25	27	19	22
49824-08-18	M-18X1,5	13/16"-16	41	28	27	19	24
49824-10-22	M-22X2,5	1"-14	49	33	34	27	27
49824-12-27	M-27X2	1-3/16"-12	55	37	37	30	32
49824-16-33	M-33X2	1-7/16"-12	59	42	41	36	41
49824-20-42	M-42X2	1-11/16"-12	63	45	44	41	50
49824-24-48	M-48X2	2"-12	69	49	47	48	55

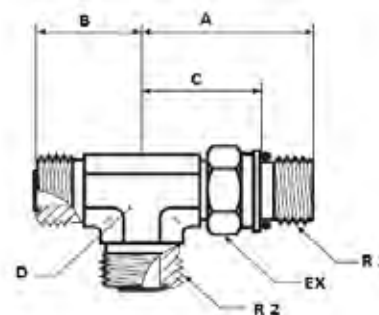

T Macho Orientable Lateral UNF - ORFS

REFERENCIA	ROSCA 1	ROSCA 2	A	B	C	D	EX
49825-04-04	7/16"-20	9/16"-18	33	22	22	14	16
49825-06-06	9/16"-18	11/16"-16	37	25	25	19	19
49825-08-08	3/4"-16	13/16"-16	41	28	27	19	24
49825-10-10	7/8"-14	1"-14	50	33	34	27	27
49825-12-12	1-1/16"-12	1-3/16"-12	55	37	37	30	35
49825-12-16	1-5/16"-12	1-3/16"-12	60	41	41	37	41
49825-16-16	1-5/16"-12	1-7/16"-12	60	42	41	37	41
49825-20-20	1-5/8"-12	1-11/16"-12	62	45	44	41	48
49825-24-24	1-7/8"-12	2"-12	66	49	47	48	54

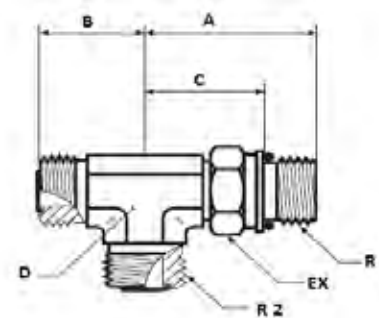

T Macho Orientable Lateral BSP - ORFS

REFERENCIA	ROSCA 1	ROSCA 2	A	B	C	D	EX
49826-04-02	1/8"-28	9/16"-18	30	22	22	14	14
49826-04-04	1/4"-19	9/16"-18	36	24	25	19	19
49826-06-04	1/4"-19	11/16"-16	36	25	25	19	19
49826-06-06	3/8"-19	11/16"-16	38	27	27	19	22
49826-08-06	3/8"-19	13/16"-16	38	28	27	19	22
49826-08-08	1/2"-14	13/16"-16	49	31	34	27	27
49826-10-08	1/2"-14	1"-14	49	33	34	27	27
49826-10-12	3/4"-14	1"-14	52	36	37	30	36
49826-12-12	3/4"-14	1-3/16"-12	52	37	37	30	36
49826-12-16	1"-11	1-3/16"-12	58	41	41	36	41
49826-16-16	1"-11	1-7/16"-12	58	42	41	36	41
49826-20-20	1-1/4"-11	1-11/16"-12	61	45	44	41	50
49826-24-24	1-1/2"-11	2"-12	65	49	47	50	55

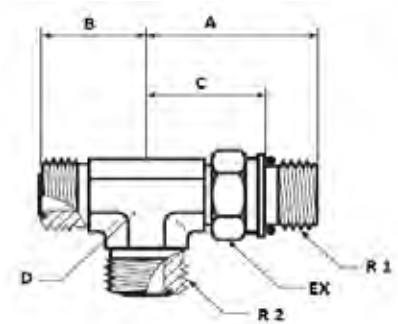

Tapón Hembra ORFS

REFERENCIA	ROSCA 1	A	B	EX
42501-04-04	9/16"-18	17	9	17
42501-06-06	11/16"-16	18	11	22
42501-08-08	13/16"-16	22	12	24
42501-10-10	1"-14	25	14	30
42501-12-12	1-3/16"-12	27	15	36
42501-16-16	1-7/16"-12	29	16	41
42501-20-20	1-11/16"-12	29	15	48
42501-24-24	2"-12	29	15	57
42501-32-32	2-1/2"-12	37	20	73

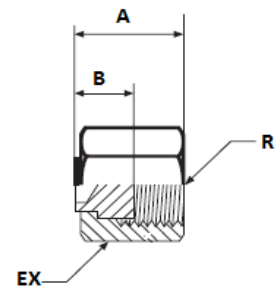

Tapón Macho ORFS

REFERENCIA	ROSCA 1	A	B	EX
4450010-04-04	9/16"-18	17	5	16
4450010-06-06	11/16"-16	19	8	19
4450010-08-08	13/16"-16	22	9	22
4450010-10-10	1"-14	26	10	27
4450010-12-12	1-3/16"-12	27	10	32
4450010-16-16	1-7/16"-12	28	10	38
4450010-20-20	1-11/16"-12	28	10	45
4450010-24-24	2"-12	28	10	54
4450010-32-32	2-1/2"-12	35	13	70

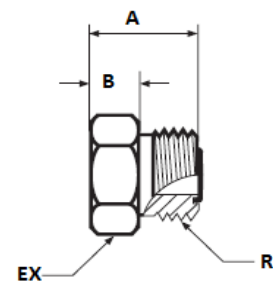

ENCHUFES RÁPIDOS Y VÁLVULAS



Enchufe Rápido Macho Caras Planas

REFERENCIA	TAMAÑO	ROSCA	PRESION MAX.	DN
TFI-2520	1/4"	1/4"-19	315 BAR	6,3
TFI-2520-38	1/4"	3/8"-19	315 BAR	6,3
TFI-3820	3/8"	3/8"-19	250 BAR	10
TFI-3820-50	3/8"	1/2"-14	250 BAR	10
TFI-5020	1/2"	1/2"-14	250 BAR	12,5
TFI-5020-75	1/2"	3/4"-14	250 BAR	12,5
TFI-7520	3/4"	3/4"-14	250 BAR	19
TFI-7520-100	3/4"	1"-11	250 BAR	19
TFI-10020	1"	1"-11	200 BAR	25
TFI-10020-125	1"	1-1/4"-11	200 BAR	25

AR SISTEMAS



Enchufe Rápido Hembra Caras Planas

REFERENCIA	TAMAÑO	ROSCA	PRESION MAX.	DN
TFI-2510	1/4"	1/4"-19	315 BAR	6,3
TFI-2510-38	1/4"	3/8"-19	315 BAR	6,3
TFI-3810	3/8"	3/8"-19	250 BAR	10
TFI-3810-50	3/8"	1/2"-14	250 BAR	10
TFI-5010	1/2"	1/2"-14	250 BAR	12,5
TFI-5010-75	1/2"	3/4"-14	250 BAR	12,5
TFI-7510	3/4"	3/4"-14	250 BAR	19
TFI-7510-100	3/4"	1"-11	250 BAR	19
TFI-10010	1"	1"-11	200 BAR	25
TFI-10010-125	1"	1-1/4"-11	200 BAR	25



Enchufe Macho Bola Alta Presión

REFERENCIA	TAMAÑO	ROSCA	PRESION MAX.	DN
PVS-B-14-M	1/4"	1/4"-19	700 BAR	6
PVS-B-38-M	3/8"	3/8"-19	700 BAR	10



Enchufe Rápido Hembra Bola Alta Presión

REFERENCIA	TAMAÑO	ROSCA	PRESION MAX.	DN
PVS-B-14-H	1/4"	1/4"-19	700 BAR	6
PVS-B-38-H	3/8"	3/8"-19	700 BAR	10



Enchufe Rápido Macho Punzón

REFERENCIA	TAMAÑO	ROSCA	PRESION MAX.	DN
10002-04-04	1/4"	1/4"-19	350 BAR	6
10002-06-06	3/8"	3/8"-19	300 BAR	10
10002-08-08	1/2"	1/2"-14	300 BAR	13
10002-12-12	3/4"	3/4"-14	250 BAR	19
10002-16-16	1"	1"-11	230 BAR	25
10002-20-20	1-1/4"	1-1/4"-11	230 BAR	32
10002-24-24	1-1/2"	1-1/2"-11	200 BAR	40
10002-32-32	2"	2"-11	130 BAR	50



Enchufe Rápido Hembra Punzón

REFERENCIA	TAMAÑO	ROSCA	PRESION MAX.	DN
10001-04-04	1/4"	1/4"-19	350 BAR	6
10001-06-06	3/8"	3/8"-19	300 BAR	10
10001-08-08	1/2"	1/2"-14	300 BAR	13
10001-12-12	3/4"	3/4"-14	250 BAR	19
10001-16-16	1"	1"-11	230 BAR	25
10001-20-20	1-1/4"	1-1/4"-11	230 BAR	32
10001-24-24	1-1/2"	1-1/2"-11	200 BAR	40
10001-32-32	2"	2"-11	130 BAR	50



Enchufe Rápido Macho Bola

REFERENCIA	TAMAÑO	ROSCA	PRESION MAX.	DN
10103-04-04	1/4"	1/4"-19	350 BAR	6
10103-06-06	3/8"	3/8"-19	300 BAR	10
10103-08-08	1/2"	1/2"-14	300 BAR	13
10103-12-12	3/4"	3/4"-14	250 BAR	19
10103-16-16	1"	1"-11	220 BAR	25



Enchufe Rápido Hembra Bola

REFERENCIA	TAMAÑO	ROSCA	PRESION MAX.	DN
10102-04-04	1/4"	1/4"-19	350 BAR	6
10102-06-06	3/8"	3/8"-19	300 BAR	10
10102-08-08	1/2"	1/2"-14	300 BAR	13
10102-12-12	3/4"	3/4"-14	250 BAR	19
10102-16-16	1"	1"-11	220 BAR	25



Enchufe Bola Tres Vias

REFERENCIA	TAMAÑO	PRESION MAX.	DN
10300-04-04	1/4"-19	500 BAR	6
10300-06-06	3/8"-19	500 BAR	10
10300-08-08	1/2"-14	500 BAR	13
10300-12-12	3/4"-14	400 BAR	19
10300-16-16	1"-11	350 BAR	25
10300-20-20	1-1/4"-11	350 BAR	32
10300-24-24	1-1/2"-11	350 BAR	40



Válvula de Bola de Dos Vias

REFERENCIA	TAMAÑO	ROSCA	PRESION MAX.	DN
10200-04-04	1/4"-19	500 BAR	6	
10200-06-06	3/8"-19	500 BAR	10	
10200-08-08	1/2"-14	500 BAR	13	
10200-12-12	3/4"-14	400 BAR	19	
10200-16-16	1"-11	350 BAR	25	
10200-20-20	1-1/4"-11	350 BAR	32	
10200-24-24	1-1/2"-11	300 BAR	40	



MÁQUINAS



KarryKrimp® 1

Prensa modular portátil para mangueras con malla

- Prensas mangueras
 - con 1 ó 2 mallas de alambre de acero hasta tamaño-20
- Disponible en diseño modular con todas las ventajas del sistema Parkrimp
- La misma unidad ofrece portabilidad y montaje en banco
- Fácilmente portable para trabajos externos
- Servicio con bomba manual o hidroneumática y eléctrica
- Portátil, diseño compacto
- Palanca pivotante para facilitar cambio de mordazas
- Su altura incrementada permite el prensado de terminales curvados más largos



Aplicaciones primarias

Pequeños talleres, tiendas de reparación, vehículos de servicio móvil.

Terminales serie

16, 26, 43, 46, 48

Restricciones

No indicada para mangueras multiespirales, terminales de dos piezas de acero inoxidable y producción en serie de latiguillos en tamaños -12 y mayor.

Datos técnicos / pedido

KarryKrimp 1	Dimensiones	Al 760 x An 335 x Pr 330 mm
	Peso	28 kg
	Referencia	82CE-061L

Incluido en equipo estándar

<i>Cabeza de prensa</i>	Referencia	82CE-CHD
<i>Soporte de prensa</i>	Referencia	85C-STD
<i>Latiguillo</i>	Referencia	85C-00L
<i>Anillo de mordazas</i>	plata	Referencia 82C-R01
	negro	Referencia 82C-R02

KarryKrimp® 2

Prensa modular portátil para mangueras de malla y multiespirales

- Prensas mangueras
 - con 1 ó 2 mallas textiles hasta tamaño -20
 - con malla triple hasta tamaño -16
 - multiespiral de 4 capas hasta tamaño -16
 - Compact Spiral hasta tamaño -12
- Disponible en sistema modular con todas las ventajas del sistema Parkrimp
- La misma unidad ofrece portabilidad y montaje en banco
- Fácilmente portable para trabajos externos
- Servicio con bomba manual o hidroneumática o eléctrica
- Portatil, diseño compacto
- Palanca pivotante para facilitar cambio de mordazas



Terminales serie
16, 26, 43, 46, 48, 70, 71, 73, 77, 78

Aplicaciones primarias

Pequeños talleres de reparación, vehículos de mantenimiento. Prensa terminales tanto de acero como de acero inoxidable.

Restricciones

No indicada para terminales de dos piezas.

Datos técnicos / pedido

KarryKrimp 2	Dimensiones	Al 805 x An 340 x Pr 350 mm
	Peso	46 kg
	Referencia	85CE-061L

Incluido en equipo estándar

Cabeza de prensa	Referencia	85CE-CHD	
Soporte de prensa	Referencia	85C-STD	
Latiguillo	Referencia	85C-00L	
Anillo de mordazas	plata	Referencia	85C-R01
	negro	Referencia	85C-R02

KarryKrimp montaje en banco

Crimpadores modulares con
unidad de potencia de banco para talleres

- Además de las versiones portátiles, las unidades de crimpado independientes se pueden usar con la unidad de potencia de banco para disponer de versiones de taller
- Ciclos más rápidos en unidades montadas en banco
- Su altura incrementada permite el prensado de terminales curvados más largos
- Los crimpadores y la unidad de potencia de banco se venden por separado.



Diseño modular = portátil + montaje en banco

El diseño modular permite al cliente escoger entre la portabilidad que siempre han ofrecido las prensas KarryKrimp, y la nueva opción para convertirlas en prensas montadas en banco.

El diseño modular da a los usuarios la flexibilidad de una prensa portátil con la ventaja de una productividad incrementada al ser conectadas a una unidad de potencia estacionaria 85CE-1PH



Datos técnicos / pedido



Presión de trabajo	70 MPa
Dimensiones	L 425 x An 525 x Al 460 mm
Peso	62 kg
Capacidad para aceite	8000 ccm
Potencia eléctrica	230 V / 50/60 Hz / 10 A
Referencia	85CE-1PE

Parkrimp® 2

Prensa en banco para todo tipo de mangueras Parkrimp *No-Skive* desde tamaño -4 hasta -32, incluyendo mangueras multiespirales de 4 y 6 capas

- Prensa mangueras
 - con 1 ó 2 mallas de alambre o textil hasta tamaño -32
 - compactas con tripe malla ... hasta tamaño -16
 - multiespirales con 4/6 capas hasta tamaño -32
 - Compact Spiral hasta tamaño -32
- Utilizada para servicio con central hidráulica con 400 V



Aplicaciones primarias

Pequeños talleres de reparación (para series pequeñas). Prensa terminales tanto de acero como de acero inoxidable.

Terminales serie

16, 26, 43, 46, 48, 70, 71, 73, 77, 78, 79, S6

Restricciones

No indicada para terminales de dos piezas.

Datos técnicos / pedido

Parkrimp 2 con unidad central, montada en banco pero sin juego de mordaza, enchufe conector y aceite

Potencia eléctrica	400 V / 4,4 kW / 8,9 A / 50 Hz	
Dimensiones	Al 1170 x An 530 x Pr 985 mm	
Peso	sin embalaje	370 kg
	con embalaje	430 kg
Referencia	83CE-083U	

Incluido en equipo estándar

<i>Adaptador</i>	Referencia	83C-0CB
<i>Anillo de mordazas</i>	Referencia	83C-R02
<i>Plato</i>	Referencia	83C-R02H

Accesorios para KarryKrimp® 1 y KarryKrimp® 2

Para uso con prensa KarryKrimp 1

Bomba manual
82C-2HP



Presión de trabajo	máx. 70 MPa
Dimensiones	L 530 x An 121 x Al 178 mm
Peso	4,1 kg
Capacidad para aceite	900 ccm
Fuerza de palanca	42 kg
Referencia	82C-2HP

Para uso con prensa KarryKrimp 1 y KarryKrimp 2

Bomba manual
85CE-0HP



Presión de trabajo	máx. 70 MPa
Dimensiones	L 580 x An 150 x Al 195 mm
Peso	10,7 kg
Capacidad para aceite	2200 ccm
Fuerza de palanca	35 kg
Referencia	85CE-0HP

Bomba turboaire
85C-0AP



Presión de trabajo	70 MPa
Dimensiones	L 350 x An 170 x Al 210 mm
Peso	8,2 kg
Capacidad para aceite	2080 ccm
Connection	aire, rosca 1/4-18 NPTF
Referencia	85C-0AP

Bomba
82CE-0EP



Presión de trabajo	70 MPa con válvula 3/2
Dimensiones	L 244 x An 244 x Al 362 mm
Peso	10,0 kg
Capacidad para aceite	1900 ccm
Potencia eléctrica	230 V / 50/60 Hz / 10 A
Referencia	82CE-0EP

Bomba hidráulica de aire
85CE-XAM



Opcional: palanca manual
Referencia
85CE-XA-LK1



Presión de trabajo	70 MPa
Dimensiones	L 351 x An 260 x Al 152 mm
Peso	8,8 kg
Capacidad para aceite	1000 ccm
Conexión	aire: hembra 1/4-18 NPT aceite: hembra giratoria 90° 3/8-18 NPT
Referencia	85CE-XAM

Unidad de potencia
en banco
85CE-1PE



Presión de trabajo	70 MPa
Dimensiones	L 425 x An 525 x Al 460 mm
Peso	62 kg
Capacidad para aceite	8000 ccm
Potencia eléctrica	230 V / 50/60 Hz / 10 A
Referencia	85CE-1PE

Latiguillo 85C-00L

Latiguillos para conectar bomba manual o bomba de aire hidráulica a la prensa



Presión de trabajo	máx. 70 MPa
Longitud	1830 mm
Conexión	3/8-18 NPT macho, enchufe 3/8"
Referencia	85C-00L

EM 10.P

Cortadora de manguera

- Corta mangueras
 - con 1 malla de acero o textiles hasta tamaño -16
 - con 2 capas de alambre hasta tamaño -12
- Pueden usarse en un banco de trabajo o en un tornillo de banco
- Hoja protegida por una cubierta de seguridad durante su uso
- Equipados con un enchufe de seguridad eléctrico



Aplicaciones primarias

Tiendas y talleres de reparación o vehículos de mantenimiento, preferiblemente en combinación con KarryKrimp 1.

Restricciones

No indicada para manguera multiespiral o mangueras industriales de diámetro ancho.

Datos técnicos / pedido

Cortadora de manguera EM 10.P

con cuchilla de corte, lisa TM 160 x 2,5 x 20

Disco de corte, liso

Motor eléctrico	motor de sierra circular 230 V
Potencia eléctrica	50/60 Hz / 1200 W / 6100 rpm
Electrical insulation	acuerdo con VDE KI.II 0740
Protección electromagnética	acuerdo con VDE 0875
Disco de corte	160 x 2,5 x 20 mm (HSS)
Dimensiones	L 360 x An 340 x Al 310 mm
Peso	8 kg
Referencia	EM 10.P
Referencia	TM 160 x 2,5 x 20

TH 3-2-12VDC

Cortadora de manguera

- Corta mangueras
 - con 1 ó 2 mallas textiles hasta tamaño -20
 - multiespiral de 4 capas hasta tamaño -16
- Para vehículos móviles de servicio con 12V



Aplicaciones primarias
Vehículos móviles de servicio.

Restricciones
No indicada para mangueras de diámetro ancho.

Datos técnicos / pedido

Cortadora de manguera TH 3-2-12VDC
con cuchilla de corte, dentada

Disco de corte, dentada 250 x 2 x 40 mm

Motor eléctrico	12 V / 2,0 kW
Disco de corte	250 x 2 x 40 mm
Dimensiones	An 567 x Pr 470 x Al 365 mm
Peso	30 kg
Referencia	TH3-2-12VDC
Referencia	TM250x2x40Z

*Motor eléctrico 24 V / 3,2 kW disponible bajo petición

TH 3E-EM3

Cortadora de manguera

- Corta mangueras
 - con 1 ó 2 mallas de acero o textiles hasta tamaño -20
 - multiespiral de 4 capas hasta tamaño -20
 - industriales hasta tamaño -32
- De acuerdo con los estándares de seguridad de la CE, la cuchilla se detiene antes de que transcurran 10 segundos tras la desconexión del motor del freno
- Corte más rápido y seguro con menor consumo de energía, motor de corte con un rodamiento del eje de mayor tamaño para garantizar una menor vibración debido a las fuerzas radiales
- Cuchillas de corte homologadas para el material considerado



Aplicaciones primarias

Talleres de reparación o vehículos de servicio móvil

Restricciones

No es adecuada para mangueras industriales de gran calibre.

Datos técnicos / pedido

Cortadora de manguera TH 3E-EM3

con cuchilla de corte, dentada TMG275x3x30

Disco de corte, dentada 275 x 3 x 30 mm

Potencia eléctrica	3 kW
Disco de corte	275 x 3 x 30 mm
Dimensiones	An 540 x Pr 440 x Al 300 mm
Peso	50 kg
Referencia	TH 3E-EM3
Referencia	TMG275x3x30

TH 3E-EM6-M

Cortadora de manguera

- Corta mangueras
 - con 1 ó 2 mallas de acero o textiles hasta tamaño -32
 - Compact Spiral hasta tamaño -32
 - multiespiral de 6 capas hasta tamaño -32
- Cuchilla de corte cubierta durante el uso
- Motor con freno de superficie y protección térmica



Aplicaciones primarias

Servicio en talleres de mangueras y para producción en serie a pequeña escala

Restricciones

Al cortar las mangueras multiespirales de 6 capas se reduce la vida útil de la cuchilla.

Datos técnicos / pedido

Cortadora de manguera TH 3E-EM6-M
con cuchilla de corte, dentada TMG350x3x30

Alimentación neumática disponible a petición.

Disco de corte, dentada 350 x 3 x 30 mm

Potencia eléctrica	400 V / 4,6 kW / 50 Hz
Ø del sistema de escape	60 mm
Disco de corte	350 x 3 x 30 mm
Dimensiones	L 745 x An 690 x Al 430 mm
Peso	75 kg
Referencia	TH3E-EM6-M
Referencia	TMG350x3x30

TH 3E-115

Cortadora de manguera

- Corta mangueras
 - todo tipo de mangueras industriales
..... D.E. hasta 75 mm
 - con 1,2 ó 3 mallas de acero o textiles
..... hasta tamaño -40
 - multiespiral de 4/6 capas hasta tamaño -32
- De acuerdo con los estándares de seguridad de la CE, la cuchilla se detiene antes de que transcurran 10 segundos tras la desconexión del motor del freno
- Corte más rápido y seguro con menor consumo de energía, motor de corte con un rodamiento del eje de mayor tamaño para garantizar una menor vibración debido a las fuerzas radiales
- Cuchillas de corte homologadas para el material considerado
- Corte más fácil de mangueras de grandes dimensiones con máquinas más eficientes energéticamente



Aplicaciones primarias

Servicio y producción en serie en talleres.

Datos técnicos / pedido

Cortadora de manguera TH 3E-115 trifásica, 400 V	Potencia eléctrica	400 V / 7.5 kW / 25 A / 50 Hz
	Ø del sistema de escape	108 mm
	Disco de corte	520 x 4 x 40 mm
	Dimensiones	L 1210 x An 650 x Al 1650 mm
	Peso	245 kg
	Referencia	TH3E-115
Disco de corte , dentada 520 x 4 x 40 mm	Referencia	TMG520 x 4 x 40

TH 3E-110

Cortadora de manguera

- Corta mangueras
 - con 1 ó 2 mallas de acero o textiles hasta tamaño -48
 - multiespiral de 4 capas hasta tamaño -48
 - multiespiral de 6 capas hasta tamaño -48
 - industriales hasta tamaño -64
- De acuerdo con los estándares de seguridad de la CE, la cuchilla se detiene antes de que transcurran 10 segundos tras la desconexión del motor del freno
- Corte más rápido y seguro con menor consumo de energía, motor de corte con un rodamiento del eje de mayor tamaño para garantizar una menor vibración debido a las fuerzas radiales
- Cuchillas de corte homologadas para el material considerado
- Corte más fácil de mangueras de grandes dimensiones con máquinas más eficientes energéticamente



Aplicaciones primarias

Servicio y producción en serie en talleres

Datos técnicos / pedido

Cortadora de manguera TH 3E-110 con cuchilla de corte, dentada TMG520x4x120	Potencia eléctrica	400 V / 7,5 kW / 25 A / 50 Hz
	Ø del sistema de escape	100 mm
	Disco de corte	520 x 4 x 120
	Dimensiones	An 800 x Pr 780 x Al 1700 mm
	Peso	280 kg
	Referencia	TH3E-110
Disco de corte, dentada 520 x 4 x 120 mm	Referencia	TMG520x4x120

TH 7-12

Carrete de manguera (7 pisos)

- Carretes de varios niveles para mangueras de tamaño -4 hasta -20
- Cada nivel (excepto el más bajo) puede desplazarse horizontalmente hacia fuera a fin de facilitar la colocación del nuevo rollo

Datos técnicos / pedido



Carrete de manguera TH 7-12
Servicio y producción en serie en talleres

Dimensiones de carrete	
Diám. interior mín. / máx.	250 mm / 1010 mm
Altura máx.	300 mm
Carga máx. por carret	80 kg
Color	zincado
Dimensiones	L 1270 x An 1000 x Al 2230 mm
Peso	148 kg
Referencia	TH7-12

TH 7-13

Carrete de manguera (1 piso)

- Carrete de un nivel para mangueras de tamaño -4 hasta -32
- Mesa ajustable para encajar el centro de la bobina

Datos técnicos / pedido



Carrete de manguera TH 7-13
Servicio y producción en serie en talleres

Dimensiones de carrete	
Diám. interior mín. / máx.	ajustable 150 - 500 mm
Carga máx. por carret	500 kg
Color	zincado / gris
Dimensiones	L 1200 x An 1200 x Al 830 mm
Peso	40 kg
Referencia	TH7-13

Certificación ISO 9001:2008

CERTIFICADO



OCA Instituto de Certificación, S.L.U.
Certifica el sistema de gestión de la calidad
de la organización

ER HIDRÁULICA, S.L.

Polígono Industrial Calonge - C/ Automoción, 29. 41007 (Sevilla)

conforme con la norma:

UNE-EN ISO 9001:2015

aplicable a:

Comercialización de material y componentes
para oleohidráulica y neumática.
Instalación y reparación de sistemas oleohidráulicos.
Montaje de latiguillos para oleohidráulica.

Certificado nº **34/5200/14/1446**

Fecha certificación inicial: 30/01/2009

Fecha certificación ciclo actual: 23/01/2018

Fecha de caducidad: 23/01/2021

Fecha auditoría renovación : 08/01/2018

Fecha de emisión de certificado: 23/01/2018



Este certificado sustituye al certificado con fecha de emisión: 23/01/2015



David Lao
Director General

Cualquier aclaración adicional relativa tanto al alcance de este certificado como a la aplicabilidad de los requisitos de la norma se puede obtener consultando a la organización.
Vía de los Dos Castillos, 7 - Ed: OCA Group - 28224 Pozuelo de Alarcón (Madrid)

Tecnologías de movimiento y control de Parker

En Parker, un incansable impulso nos guía para ayudar a los clientes a hacer posible cualquier proyecto. Ser un proveedor de soluciones significa ayudar a nuestros clientes a conseguir niveles más elevados de rentabilidad diseñando los mejores sistemas para sus necesidades. Significa examinar las aplicaciones del cliente desde muchos ángulos para encontrar nuevas formas de crear valor. Cualquiera que sea la necesidad de movimiento y control, Parker tiene la experiencia, gama de productos y alcance mundial para cumplir siempre. Ninguna empresa conoce mejor el movimiento y el control que Parker. Para más información contacte gratuitamente en 00800 27 27 5374



AEROSPACIAL

Mercados Clave

- Motores de aviones
- Aviación comercial y general
- Transportes comerciales
- Sistemas de armas basados en tierra
- Aviación militar
- Vehículos de misiles y lanzaderas
- Transportes regionales
- Vehículos aéreos no tripulados

Productos Clave

- Sistemas y componentes de control de vuelo
- Sistemas de transmisión de fluido
- Dispositivos de entrega y atomización de contadores de fluido
- Sistemas y componentes de combustible
- Sistemas y componentes hidráulicos
- Sistemas de generación de nitrógeno inerte
- Sistemas y componentes neumáticos
- Ruedas y frenos



CONTROL DEL CLIMATIZACIÓN

Mercados Clave

- Agricultura
- Aire acondicionado
- Alimentación, bebidas y lácteos
- Ciencias médicas / de la vida
- Refrigeración de precisión
- Proceso
- Transporte

Productos Clave

- Controles de CO2
- Controladores electrónicos
- Secadores de filtros
- Válvulas de cierre manual
- Mangueras y racores
- Válvulas de regulación de presión
- Distribuidores de refrigerante
- Válvulas de seguridad
- Válvulas de solenoide
- Válvulas de expansión termostática



ELECTROMECÁNICA

Mercados Clave

- Aeroespacial
- Automatización de fábricas
- Alimentación y bebidas
- Ciencias médicas / de la vida
- Máquinas herramientas
- Maquinaria de embalaje
- Maquinaria de papel
- Maquinaria y conversión de plásticos
- Metales primarios
- Semiconductores y electrónica
- Textil
- Alambre y cable

Productos Clave

- Accionamientos y sistemas de CA/VCC
- Actuadores eléctricos
- Controladores
- Robots de pórtico
- Reductores
- Interface hombre máquina
- PCs Industriales
- Convertidores de frecuencia
- Motores lineales
- Guías de precisión
- Motores paso a paso, servomotores, accionamientos y controladores
- Extrusiones para estructuras



FILTRACIÓN

Mercados Clave

- Alimentación y bebidas
- Maquinaria industrial
- Ciencias de la vida
- Marítimo
- Equipo móvil
- Petróleo y gas
- Generación de energía
- Proceso
- Transporte

Productos Clave

- Generadores analíticos de gas
- Filtros de aire comprimido y gas
- Monitorización de condiciones
- Filtración y sistemas de aire, combustible y aceite de motores
- Hidráulica, lubricación y filtros refrigerantes
- Filtros de proceso, químicos, de agua y microfiltración
- Generadores de nitrógeno, hidrógeno y aire cero



GESTIÓN DE FLUIDOS Y GAS

Mercados Clave

- Aeroespacial
- Agricultura
- Manejo de productos químicos a granel
- Maquinaria para la construcción
- Alimentación y bebidas
- Suministro de combustible y gas
- Maquinaria industrial
- Móvil
- Petróleo y gas
- Transporte
- Soldadura

Productos Clave

- Racores y válvulas de latón
- Equipo para diagnósticos
- Sistemas de transmisión de fluido
- Manguera industrial
- Mangueras, tubos y racores PTFE & PFA
- Mangueras de goma y termoplásticas y enchufes
- Racores y adaptadores de tubos
- Enchufes rápidos



HIDRÁULICA

Mercados Clave

- Aeroespacial
- Transporte aéreo
- Agricultura
- Maquinaria para la construcción
- Silvicultura
- Maquinaria industrial
- Minería
- Petróleo y gas
- Generación de energía
- Hidráulica de camiones

Productos Clave

- Equipo para diagnósticos
- Cilindros y acumuladores hidráulicos
- Motores y bombas hidráulicas
- Sistemas hidráulicos
- Válvulas y controles hidráulicos
- Tomas de fuerza
- Mangueras de goma y termoplásticas y enchufes
- Racores y adaptadores de tubos
- Enchufes rápidos



NEUMÁTICA

Mercados Clave

- Aeroespacial
- Manejo de cintas transportadoras y material
- Automatización de fábricas
- Ciencias médicas / de la vida
- Máquinas herramientas
- Maquinaria de embalaje
- Transporte y automoción

Productos Clave

- Preparación de aire
- Cilindros compactos
- Sistemas de bus de campo
- Pinzas
- Cilindros guiados
- Manifolds
- Válvulas miniatura
- Accesorios neumáticos
- Actuadores y pinzas neumáticas
- Válvulas y controles neumáticos
- Cilindros sin vástago
- Cilindros de giro
- Cilindros de tirantes
- Generadores de vacío, ventosas y sensores



CONTROL DE PROCESO

Mercados Clave

- Química/refinería
- Alimentación, bebidas y lácteos
- Médica y dental
- Microelectrónica
- Petróleo y gas
- Generación de energía

Productos Clave

- Productos y sistemas para acondicionamiento de muestras analíticas
- Racores, válvulas y bombas de suministro de productos químicos a base de fluoropolímeros
- Racores, válvulas y reguladores de suministro de gas de elevada pureza
- Racores, válvulas y reguladores de instrumentación
- Racores y válvulas de media presión
- Colectores de control de proceso



SELLADO Y APANTALLADO

Mercados Clave

- Aeroespacial
- Proceso químico
- Consumo
- Energía, petróleo y gas
- Energía de fluido
- Industrial general
- Tecnología de la información
- Ciencias de la vida
- Militar
- Semiconductores
- Telecomunicaciones
- Transporte

Productos Clave

- Juntas de estanqueidad dinámicas
- Juntas tóricas elastómeras
- Apantallado EMI
- Juntas de estanqueidad elastómeras extruidas/ cortadas/ fabricadas con precisión
- Perfiles elastómeros homogéneos e insertados
- Juntas de estanqueidad de metal a alta temperatura
- Juntas de estanqueidad de composite con metal y plástico
- Gestión térmica

24 horas al día - 365 días al año con el servicio HOSE DOCTOR

660 411 303 Sevilla

629 616 779 Huelva



E. R. HIDRAULICA S.L.
HIDRAULICA - NEUMATICA

SEVILLA
E. R. HIDRAULICA S.L.

Polígono Industrial Calonge
C/. Automoción, 29
41007 Sevilla (España)
Tel.: +34 95 435 84 51 / +34 95 435 09 46
Fax: +34 95 435 88 16
erhidraulica@erhidraulica.es
www.erhidraulica.es

HUELVA
E. R. HIDRAULICA S.L.

Polígono Industrial San Diego
Ctra. Huelva - San Juan del Puerto, Km 6
21007 Huelva (España)
Tel.: +34 959 224 833
Fax: +34 95 435 88 16
erhidraulica@erhidraulica.es
www.erhidraulica.es

